

tekmar® Submittal

Indoor Sensor 076



Accessories

C076

01/11

Replaces: New

Job _____ Designer _____ Contact _____

The Indoor Sensor 076 is designed to provide remote temperature sensing when connected to a compatible thermostat, RTU, or control. It can be used in installations that use a boiler control but want Indoor Temperature Feedback for increased efficiency and comfort. This product can be connected to a control to provide temperature sensing at any location where it is installed.

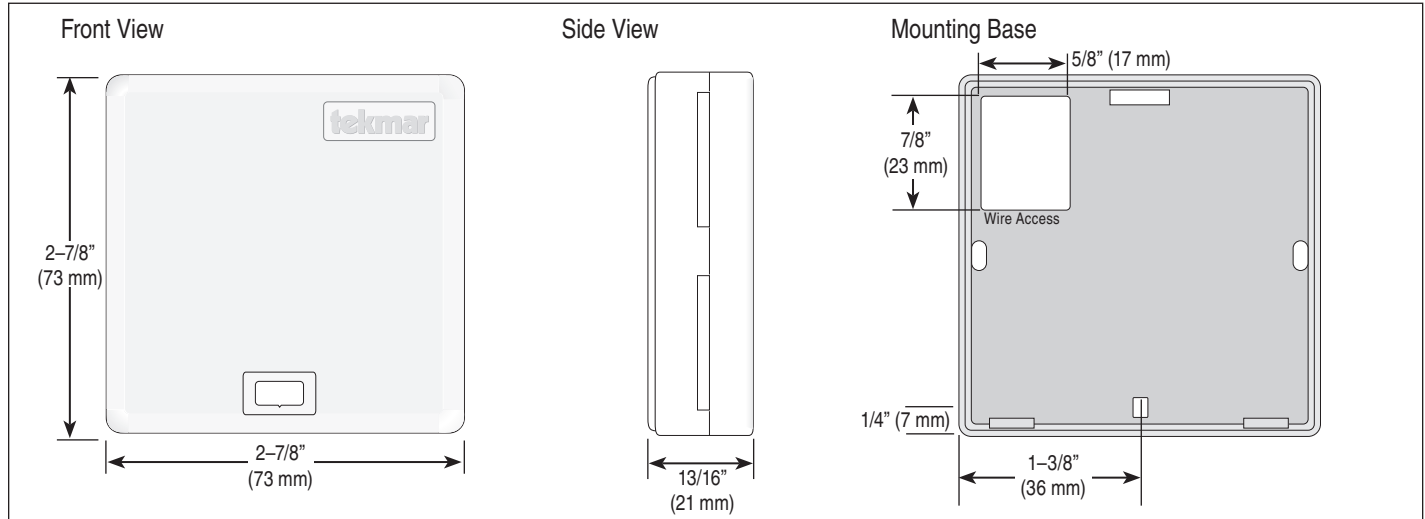

Specifications

Indoor Sensor 076	
Literature	D074
Packaged weight	0.2 lb. (90 g)
Dimensions	2-7/8" H x 2-7/8" W x 13/16" D (73 x 73 x 21 mm)
Enclosure	White PVC plastic, NEMA type 1
Approvals	CSA C US
Operating range	-60 to 140°F (-51 to 60°C)
Sensor	NTC thermistor, 10 kΩ @ 77°F (25°C ±0.2°C) β=3892
Warranty	Limited 3 Year (See D074 for full warranty)

Features

- 10K thermistor
- Compatible with tekmar thermostats that support auxiliary sensing

Temperature vs. Resistance

Temperature		Resistance	Temperature		Resistance	Temperature		Resistance	Temperature		Resistance
°F	°C	Ω	°F	°C	Ω	°F	°C	Ω	°F	°C	Ω
-40°	-40°	336,479	68°	20°	12,493	176°	80°	1,255	284°	140°	235
-31°	-35°	242,681	77°	25°	10,000	185°	85°	1,070	293°	145°	208
-22°	-30°	176,974	86°	30°	8,057	194°	90°	915	302°	150°	186
-13°	-25°	130,421	95°	35°	6,531	203°	95°	786	311°	155°	166
-4°	-20°	97,081	104°	40°	5,326	212°	100°	678	320°	160°	148
5°	-15°	72,957	113°	45°	4,368	221°	105°	587	329°	165°	133
14°	-10°	55,329	122°	50°	3,602	230°	110°	510	338°	170°	119
23°	-5°	42,327	131°	55°	2,986	239°	115°	445	347°	175°	107
32°	0°	32,650	140°	60°	2,488	248°	120°	389	356°	180°	97
41°	5°	25,392	149°	65°	2,083	257°	125°	341	365°	185°	87
50°	10°	19,901	158°	70°	1,752	266°	130°	301	374°	190°	79
59°	15°	15,712	167°	75°	1,480	275°	135°	265	383°	195°	72

SPECIAL REQUIREMENTS

N / A



tekmar Control Systems Ltd., Canada, tekmar Control Systems, Inc., U.S.A. **Head Office: 5100 Silver Star Road, Vernon, B.C. Canada V1B 3K4, 250-545-7749, Fax. 250-545-0650 Web Site: www.tekmarcontrols.com**

