

## RDG160TU Commercial Thermostat

### Selecting Location

Install the thermostat about 4 feet (120 cm) above the floor on an inside wall. Ensure that there is free airflow around the thermostat. Do not install the thermostat near windows or doors, in direct or radiant heat of sunlight, on unconditioned outside walls or near heating or cooling duct outlets. Not following these prerequisites will adversely affect the thermostat's sensed temperature and its control performance. See Figure 1.

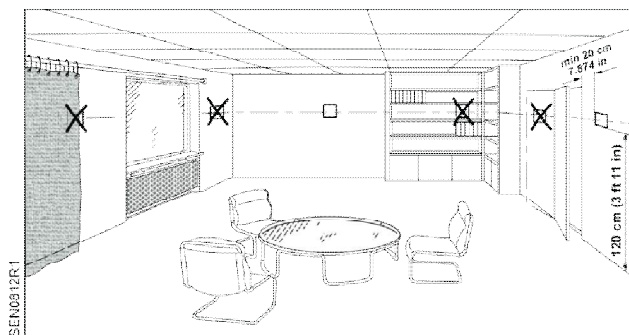
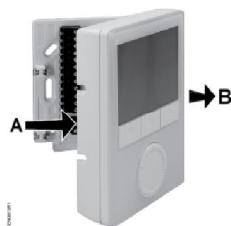

Figure 1. Mounting Location.

### Installation



Step 1. Loosen retaining screws.



Step 2. Remove thermostat from back plate, if attached.

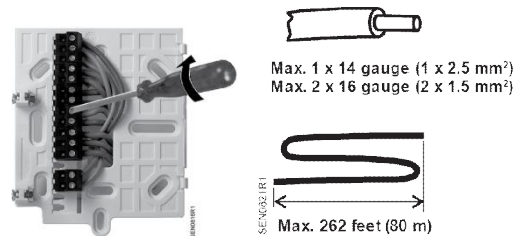

Step 3. Mount back plate at desired location and terminate wiring connections. See maximum wire size (above).

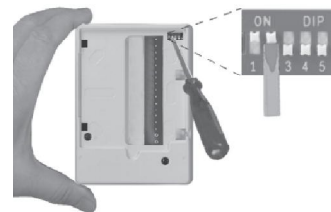

Step 4. Set application DIP switches. See *DIP Switch Settings*.

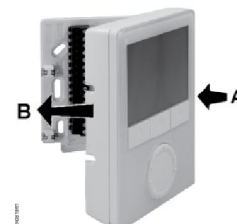

Step 5. Pivot thermostat onto back plate.



Step 6. Snap into place and tighten mounting screws.

## Thermostat Termination Reference

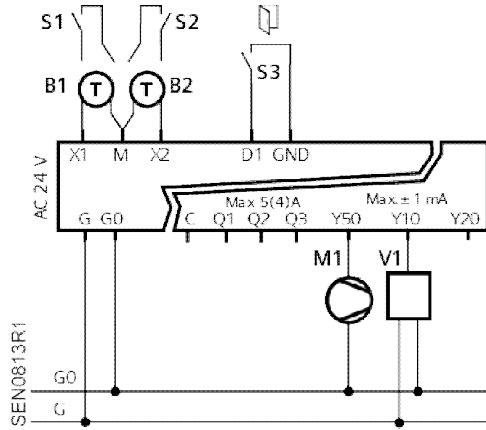

**NOTE:**

24 Vac power to be supplied by Class 2 rated transformer.

- G Operating voltage, 24 Vac L
- G0 Operating voltage, 24 Vac N
- X1 Input 1 signal (Digital In or 3K Ω NTC)
- X2 Input 2 signal (Digital In or 3K Ω NTC)
- M Input 1 and 2 Common
- D1 Digital input signal (example: occupancy)
- GND Digital input Common
- Q1~3 Relays outputs for 2-position valve, Speeds 1 to 3 for 3-speed fan
- Y50 0 to 10V output for ECM Fan
- Y10 0 to 10V output for H/C valve (2-pipe) or Heating valve (4-pipe) applications
- Y20 0 to 10V output for Radiator or Electric heat (2-pipe) or Cooling valve (4-pipe) applications
- C 24 Vac L for relay outputs

## Setting Up Applications

Use the DIP switches to set up Basic Applications.

Use the Control Parameter set up on the front panel to set up additional application customization or special set up can be set up. See *Parameter Set Up in Service Level*.

If no Applications are set up, the front panel displays **NO APP.**

## Diagnostics Mode

In addition to standard Service level control parameter set up, the RDG160TU also has an Expert Level for the advanced user to perform diagnostics and troubleshooting. See Table 3.

## DIP Switch Settings

### Overview

Applications are set up with DIP switches 1 through 3.



















DIP Switch 4 selects ECM Fan (**OFF**) or 3-Speed Fan (**ON**).







DIP Switch 5 (**ON**) disables time program functions; time is not displayed.



Following is the set up of the most common applications and any supporting parameters to be set using the Service Menu after installation. For other application settings or detailed control functions, see *Room Thermostats with LCD for Wall Mounting RDG100, RDG100T, RDG110, RDG140, RDG160, RDG100T/H Basic Documentation (CE1P3181)*.

HEAT PUMP (Manual changeover only, no reversing valve support)	Heat OR Cool Compressor (Q1) Only	Heat OR Cool Compressor (Q1) with 2-Position Electric Heat (Q2)	Heat (Q1) AND Cool (Q2) Compressors	2-Stage Heat OR Cool (Q1, Q2)
ECM Fan (Y50)	<p>P46 = 1</p>	<p>P46 = 1 P47 = 1</p>	<p>P46 = 1 P47 = 1</p>	

<b>2-PIPE FCU</b>	2-Position Valve (Q1)	Modulating Valve (Y10)	<b>2-PIPE FCU with HEAT</b>	2-Position Valve (Q1) with ON-OFF Electric Heat (Q2)	Modulating Valve (Y10) with Modulating Electric Heat (Q2)	Modulating Valve (Y10) with Modulating Electric Heat (Y20)	<b>2-PIPE FCU with RADIATOR</b>	2-Position Valve (Q1) with 2-Position Radiator (Q2)	Modulating Valve (Y10) with 2-Position Radiator (Q2)	Modulating Valve (Y10) with Modulating Radiator (Y20)
ECM Fan (Y50)	 P46 = 1		ECM Fan (Y50)	 P46 = 1 P47 = 1	 P46 = 2 P47 = 1		ECM Fan (Y50)	 P46 = 1 P47 = 1	 P46 = 2 P47 = 1	
3-Speed Fan (Q1-Q3)			3-Speed Fan (Q1-Q3)				3-Speed Fan (Q1-Q3)			
<b>Chilled / Heated Ceiling</b>	2-Position Valve (Q1)	Modulating Valve (Y10)		2-Position valve (Q1) with 2-Position Electric Heater (Q2)	Modulating Valve (Y10) with 2-Position Electric Heater (Q2)	Modulating Valve (Y10) with Modulating Electric Heater (Y20)		2-Position Valve (Q1) with 2-Position Radiator (Q2)	Modulating Valve (Y10) with 2-Position Radiator (Q2)	Modulating Valve (Y10) with Modulating Radiator (Y20)
	 P46 = 1			 P46 = 1 P47 = 1	 P46 = 2 P47 = 1			 P46 = 1 P47 = 1	 P46 = 2 P47 = 1	

<b>4-PIPE FCU</b>	2-Position Heating (Q1) and Cooling (Q2) Valves	Modulating Heating (Y10) and Cooling (Y20) Valves	<b>2-STAGE</b>	2-Position Heating (Q1) and Cooling (Q2) Valves	Modulating Heating (Y10) and Cooling (Y20) Valves
ECM Fan (Y50)	 P46 = 1 P47 = 1		ECM Fan (Y50)	 P46 = 1 P47 = 1	
3-Speed Fan (Q1-Q3)			3-Speed Fan (Q1-Q3)		

## Parameter Set Up in Service Level



To change control parameters, do the following:

1. Press the **HEAT/COOL** and **FAN/OK** buttons simultaneously for at least 4 seconds.
2. Release them and, within 2 seconds, press the **HEAT/COOL** button again until **P01** displays.
3. Select the required parameter by turning the rotary knob.
4. Press the **FAN/OK** button ✓. The selected parameter value blinks. Change the value by turning the rotary knob.
5. Press the **FAN/OK** button ✓ to confirm the change, or the **HEAT/COOL** button ↵ (Esc) to cancel the change.
6. Repeat Steps 3 through 5 for more parameters or press **HEAT/COOL** ↵ (Esc) to exit.

To return to the factory-default control parameters, do the following:

1. Change the value of **Parameter P71** to **ON**.
2. Press the **FAN/OK** button ✓ to confirm the change.

When reloading, the screen displays **8888**.

### NOTES:

- Use Comfort mode for Occupied settings.
- Use Economy mode for Unoccupied settings.
- Use Protection mode for Frost Protection.

**Table 1. Service Level Parameters.**

Parameter	Name	Factory Setting	Range	Dependencies
P01	Control sequence	With 2-pipe/2-stage: 1 = cooling only With 4-pipe: 4 = H/C	0 = Heating only 1 = Cooling only 2 = H/C changeover manual 3 = H/C changeover automatic 4 = Heating and cooling	
P02	Operating mode profile (operating mode button)	1	1 = (Auto) – Comfort – Protection 2 = (Auto) – Comfort – Economy – Protection 3 = Comfort – Protection 4 = Comfort – Economy – Protection	P01
P03	Fan mode selection	0	0 = Auto – Manual 1 = Manual 2 = Auto – Manual – Protection 3 = Auto – Protection	P52
P04	Selection of °C or °F	Also set during initial set-up	0 = Degrees Celsius (°C) 1 = Degrees Fahrenheit (°F)	
P05	Sensor calibration (internally, externally)	0°F (0°C)	-6°F to 6°F (-21°C to -14°C)	
P06	Standard temperature display	0	0 = Room temperature 1 = Setpoint	
P08	Comfort setpoint	70°F (21°C)	41°F to 104°F (5°C to 40°C)	
P09	Minimum setpoint for Comfort mode	41°F (5°C)	41°F to 104 °F (5°C to 40°C)	
P10	Maximum setpoint for Comfort mode	95°F (35°C)	41°F to 104°F (5°C to 40°C)	
P11	Economy heating setpoint	59°F (15°C)	OFF, 41°F to 104°F (5°C to 40°C max.)	
P12	Economy cooling setpoint	86°F (30°C)	OFF, 41°F to 104°F; 5°C to 40°C (min.)	
P13	Electric heater in cooling mode	ON	ON = Enabled OFF = Disabled	Application
P14	Button lock function	0	0 = Unlocked 1 = Auto lock 2 = Manual lock	
P15	Fan stage in deadband (Comfort mode)	0	0 = Disabled 1 = Stage 1 (heating and cooling) 2 = Stage 1 (cooling only)	

## Diagnostics and Testing using Expert Level

To change control parameters, do the following:

1. Press the **HEAT/COOL** and **FAN/OK** buttons simultaneously for at least 4 seconds.
2. Release them, and within 2 seconds, press the **FAN/OK** button ✓ again until the temperature does not display.
3. Turn the rotary knob counterclockwise a minimum 1/2 rotation.  
**Pxx** displays. Select the required parameter by turning the rotary knob.
4. Press the **FAN/OK** button ✓. The current value of the selected parameter blinks and can be changed by turning the rotary knob.
5. Press the **FAN/OK** button ✓ to confirm the adjusted value or press the **HEAT/COOL** button ⏏ (Esc) to cancel the change.
6. To adjust additional parameters, repeat Steps 3 through 5.
7. Press the **HEAT/COOL** button ⏏ (Esc) to exit the parameter setting mode.

To return to the factory-default control parameters, do the following:

1. Change the value of **Parameter P71** to **ON**.
2. Press the **FAN/OK** button ✓ to confirm the change.

When reloading, the screen displays **8888**.

### NOTES:

- Parameters **P46** and **P47**: Use DIP switches 4 and 5 to set to 2-position or 3-position.
- Parameter **P45** compensates for heat dissipation of the electric heater relay.
- If no sensors or switches are connected, it is not necessary to disable the inputs (**P38**, **P40** or **P42** = no function), the thermostat recognizes if a sensor is connected (but diagnostic displays **Err**).







**Table 2. Expert Level Parameters.**

Parameter	Name	Factory Setting	Range	Dependencies
P30	P-band/switching differential in heating mode	4°F (-15°C)	1°F to 12°F (-17°C to -11°C)	
P31	P-band/switching differential in cooling mode	2°F (-16°C))	1°F to 12°F (-17°C to -11°C)	
P32	P-band/switching differential for radiator	4°F (-15°C)	1°F to 12°F (-17°C to -11°C)	Application
P33	Deadband in Comfort mode	4°F (-15°C)	1°F to 10°F (-17°C to -12°C)	Application
P34	Setpoint differential (w <sub>D</sub> )	4°F (-15°C)	1°F to 10 F (-17°C to -12°C)	Application
P35	Integral action time	45 minutes	0 to 120 minutes	P46, P47
P36	Heating/cooling changeover switching point cooling (X1/X2)	61°F (16°C)	50°F to 77°F (10°C to 25 C)	P38, P40
P37	Heating/cooling changeover switching point heating (X1/X2)	82°F (27°C)	81°F to 104°F (27°C to 40°C)	P38, P40
P38	Functionality of X1	1 = External sensor	0 = --- (No function) 1 = Room temp ext/ret air temp (AI) 2 = H/C changeover (AI/DI) 3 = Operating mode contact (DI) 4 = Dewpoint sensor (DI) 5 = Enable electric heater (DI) 6 = Fault input (DI) 9 = Supply air sensor	
P39	Operating action of X1 if digital input	NO	NO = Normally open/open NC = Normally closed/closed	P38
P40	Functionality of X2	2 = H/C changeover	0 = --- (No function) 1 = Room temp ext/ret air temp (AI) 2 = H/C changeover (AI/DI) 3 = Operating mode contact (DI) 4 = Dewpoint sensor. (DI) 5 = Enable electric heater (DI) 6 = Fault input (DI) 9 = Supply air sensor	

Parameter	Name	Factory Setting	Range	Dependencies
P41	Operating action of X2 if digital input	NO	NO = Normally open/open NC = Normally closed/closed	P40
P42	Functionality of D1	3 = Operating mode changeover	0 = --- (no function) 2 = H/C changeover (DI) 3 = Operating mode contact (DI) 4 = Dewpoint sensor (DI) 5 = Enable electric heater (DI) 6 = Fault input (DI)	
P43	Operating action of D1 if digital input	NO	NO = Normally open/open NC = Normally closed/closed	P42
P45	Power of electric heater on Q2 (for adaptive temperature compensation)	0 kW	0.0 to 1.2 kW	
P46	Outputs Y10 (DC) or Q1 (2-pos)	DC 0 to 10V (2)	1 = On/Off 2 = DC 0 to 10V	Application
P47	Outputs Y20 (DC) or Q2 (2.pos)	DC 0 to 10V (2)	1 = On/Off 2 = DC 0 to 10V	Application
P48	Min. output on time 2-position control output	1 minute	1 to 20 minutes	P46
P48	Min. output OFF time on Q1, Q2 and Q3, Relay function P72, P73, P74 (=2,3,4,5):	1 minute	1 to 20 minutes	Application P7x
P49	Min. output off time 2-position control output	1 minute	1 to 20 minutes	P47
P49	Min. output OFF time on Q1, Q2 and Q3 Relay function P72, P73, P74 (=2,3,4,5):	1 minute	1 to 20 minutes	Application P7x
P50	Purging function (only when changeover with local sensor is selected)	OFF	OFF: Not active 1 to 5 min: Active with selected duration	P38, P40
P51	Floor heating limit temperature	OFF	OFF, 50°F to 122°F (10°C to 50°C)	P38, P40
P52	Fan operation	1	0 = Disabled 1 = Enabled 2 = Heating only 3 = Cooling only	
P53	Fan speed	DC 0 to 10V	1 = 1-speed fan 2 = 3-speed fan 3 = DC 0 to 10V (ECM fan)	P52 DIP4
P54	Fan overrun time (only when electric heater is used)	60 seconds	0 to 360 seconds	P52, Application
P55	Switching point fan speed high	100%	80 to 100%	P52
P56	ECM fan max. output	ECM: 80%	ECM: fan min to 100%	P52
	Switching point fan speed medium	65%	30% to 75%	P52
P57	ECM fan min. output	ECM: 30%	ECM: 1% to fan max.	P52
	Switching point fan speed low	10%	1% to 15%	P52
P58	ECM: Switching point fan	ECM:10%	ECM: 1% to 100%	P52
P58	Fan start booster	ON	ON: Enabled OFF: Disabled	P52
P59	Fan min. on time	2 minutes	1 to .6 minutes	P52
P60	Fan kick interval in Comfort mode (time until next kick)	OFF	0 to 89 minutes, OFF	P52
P61	Fan kick interval in Economy mode (time until next kick)	OFF	0 to 359 minutes, OFF	P52
P62	Clean filter reminder running time	OFF (0)	OFF, 100 to 9900 hours	P52
P63	Minimum supply air temperature	OFF	OFF, 32°F to P64 °F (0°C to P64 °C)	P38, P40
P64	Maximum supply air temperature	OFF	OFF, P63 °F to 122°F (P63 °C to 50°C)	P38, P40
P65	Protection heating setpoint	8°C	OFF, 41°F to 104°F (5°C to 40°C max.)	
P66	Protection cooling setpoint	OFF	OFF, 41°F to 104°F; 5°C to 40°C (min.)	
P67	Fan start delay	0 seconds	0 through 360 seconds	P52, P46, P47
P68	Extension Comfort period	OFF (0)	OFF(0); 15 through 360 minutes	P02
P69	Temporary setpoint Comfort mode (see also Comfort setpoint P08)	OFF	OFF = Disabled ON = Enabled	
P70	Infrared receiver (Not available)	ON	OFF = Disabled ON = Enabled	
P71	Reload factory settings	OFF	OFF = Disabled ON = Reload start	

Parameter	Name	Factory Setting	Range	Dependencies
P72	Output Q1 function	0	0 = No function 1 = Switch OFF in Protection 2 = Switch ON in H/C demand (2-pipe) 3 = Switch ON in H demand (4-pipe) 4 = Switch ON in C demand (4-pipe) 5 = Status active sequence (H or C)	Application
P73	Output Q2 function	0	0 = No function 1 = Switch OFF in Protection 2 = Switch ON in H/C demand (2-pipe) 3 = Switch ON in H demand (4-pipe) 4 = Switch ON in C demand (4-pipe) 5 = Status active sequence (H or C)	Application
P74	Output Q3 function	0	0 = No function 1 = Switch OFF in Protection 2 = Switch ON in H/C demand (2-pipe) 3 = Switch ON in H demand (4-pipe) 4 = Switch ON in C demand (4-pipe) 5 = Status active sequence (H or C)	Application

**Table 3. Diagnostics and Tests.**

Parameter	Name	Factory Setting	Range	Dependencies
d01	Application type	Diagnostics	0 = (no application) 1 = 2-pipe 2 = 2-pipe with electric heater 3 = 2-pipe with radiator 4 = 4-pipe 5 = 2 stage heating or cooling 6 = 4-pipe with electric heater	
d02	X1 status	Diagnostics	"---" = Function not selected 0 = Not activated (for DI) 1 = Activated (DI) 32°F to 120°F (0°C to 49°C) = Curr. temp. value (for AI) Err 00  = H/C input closed 100  = H/C input open	
d03	X2 status	Diagnostics	"---" = Function not selected 0 = Not activated (for DI) 1 = Activated (DI) 32°F to 120°F (0°C to 49°C) = Curr. temp. value (for AI) Err 00  = H/C input closed 100  = H/C input open	
d04	D1 status	Diagnostics	"---" = Function not selected 0 = Not activated (for DI) 1 = Activated (DI) 00  = H/C input closed 100  = H/C input open	
d07	Software version	---	<b>Ux.xx</b> displays	
d08	Test mode for checking Q1 output	---	"---" = No signal at output Q1 OPE = Output Q1 forced opening CLO = Output Q1 forced closing	P72, Application
d09	Test mode for checking Q2 output	---	"---" = No signal at output Q2 OPE = Output Q2 forced opening CLO = Output Q2 forced closing	P73, Application
d10	Test mode for checking Q3 output	---	"---" = No signal at output Q3 OPE = Output Q3 forced opening CLO = Output Q3 forced closing	P74, Application

## Dimensions

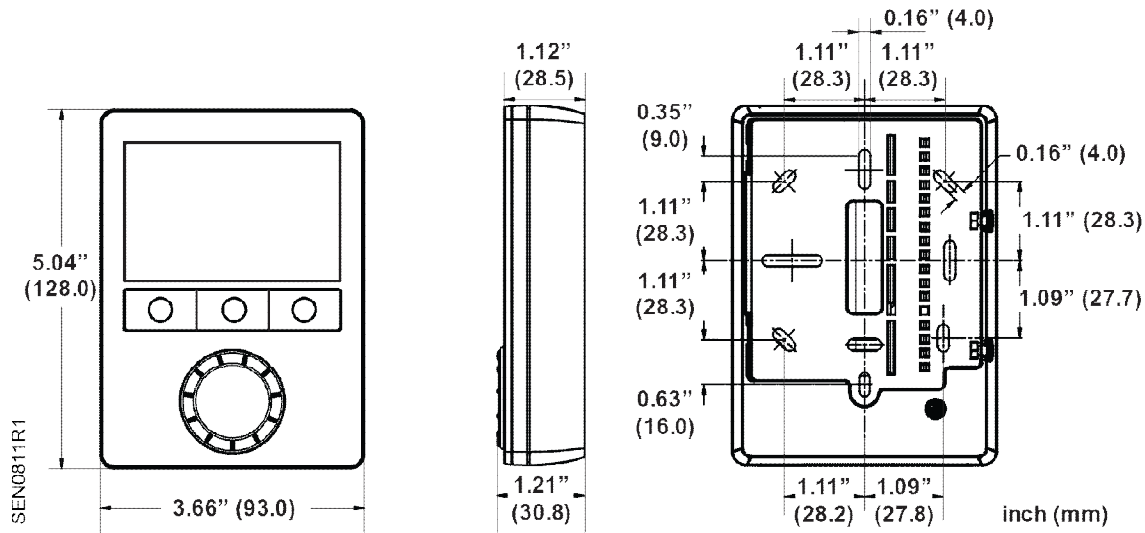

**Figure 2. Dimensions in Inches (Millimeters).**

Information in this publication is based on current specifications. The company reserves the right to make changes in specifications and models as design improvements are introduced. Product or company names mentioned herein may be the trademarks of their respective owners. © 2016 Siemens Industry, Inc.