







Series FS8-W General Purpose Liquid Flow Switch

OPERATION

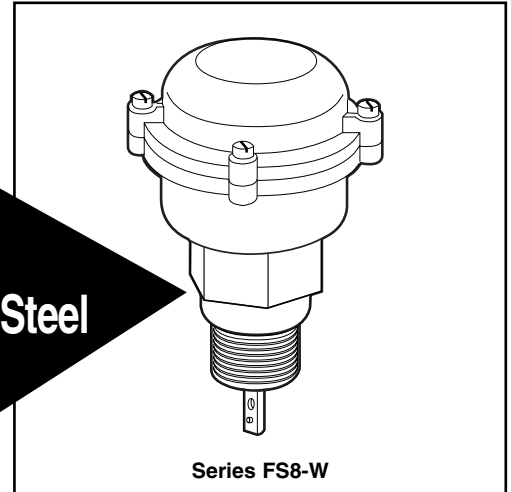
This control is an independently mounted water flow sensing device that makes or breaks an electrical circuit when flow stops or starts.

Now
with
Stainless Steel
Paddles



 WARNING	
	<ul style="list-style-type: none">• Before using product, read and understand instructions.• Save these instructions for future reference.
	<ul style="list-style-type: none">• All work must be performed by qualified personnel trained in the proper application, installation, and maintenance of plumbing, steam and electrical equipment and/or systems in accordance with all applicable codes and ordinances.• To prevent electrical shock, turn off the electrical power before making electrical connections.• To prevent an electrical fire or equipment damage, electrical wiring insulation must have a rating of 167°F (75°C) if the liquid's temperature exceeds 180°F (82°C).
	<ul style="list-style-type: none">• To prevent electrocution, when the electrical power is connected to the flow switch, do not touch the terminals.• Make sure flow switch electrical cover is secured before turning on electric power.
<p>Failure to follow this warning could cause property damage, personal injury or death.</p>	

SPECIFICATIONS

Maximum Liquid Pressure: 160 psi (11.3 kg/cm²)

Liquid Temperature Range (T_L): 32 - 225°F (0 - 107°C)

Ambient Temperature Range (T_s): 32 - 120°F (0 - 49°C)

Electrical Enclosure Rating: Nema Type 4X (IP 56)

Maximum Velocity: 10ft/sec (3M/sec)

Pipe Connection Thread Size: - 1" NPT - *All models except "J"*
- 1" BSPT - *"J" models*

ELECTRICAL RATINGS

Voltage	Motor Switch Rating (Amperes)		Pilot Duty
	Full Load	Locked Rotor	
120 VAC	7.4	44.4	125 VA at 120 or 240 VAC 50 or 60 cycles
240 VAC	3.7	22.2	

CE Circuit Rating	
7.4 (7.4)/120~	0.3/120=
3.7 (3.7)/240~	0.15/240=

NOTE: Switch on 'G' models is rated for 300 watts @ 125VAC.

Models that meet CE Conformance: FS8-WJA-E

- **This Control:** is for continuous operations
is not electronic
has Type 1C action (micro
interruption on operation)

- **LVD 73/23/EEC**

- **EMC 89/33/EEC**

For applications with loads between 0.5 and 3.7 Amps, power factors exceeding 0.65, an anticipated system switch operation rate of less than once per 2.5 minutes, and any one cycle greater than 3 seconds on and 3 seconds off.

For applications with loads 0.5 and 38mA, power factors exceeding 0.65, an anticipated system switch operation rate of less than once per 5 minutes, and any one cycle greater than 3 seconds on and 3 seconds off.

Additional suppression may be required for applications outside these ranges.

- **Declaration of Conformity**
Available on request.

FLOW RATES

Flow rates required to activate flow switch are shown in chart below. The values are calculated for sensing water (potable, non-polluted) in a horizontal pipe.

Settings will vary when used to sense flow of other fluids or if located in a vertical pipe.

Pipe Size NPT in. (mm)	Settings	Mode of Operation				Max. Flow Rate gpm (lpm) w/o Paddle Damage
		Flow gpm (lpm)	Velocity fps (mps)	No Flow gpm (lpm)	Velocity fps (mps)	
1 (25)	Factory or Minimum	4.9 (18.5)	1.82 (.55)	3.4 (12.9)	1.25 (.38)	27 (102)
	Maximum	17.6 (66.6)	6.53 (2.60)	15 (56.8)	5.56 (1.69)	
1¼ (32)	Factory or Minimum	7.5 (28.4)	1.60 (.49)	5.3 (20.1)	1.14 (.35)	47 (178)
	Maximum	29 (110)	6.23 (1.9)	24.6 (93.1)	5.28 (1.61)	
1½ (40)	Factory or Minimum	9.4 (35.6)	1.48 (.45)	6.7 (25.4)	1.05 (.32)	63 (239)
	Maximum	37.8 (143)	5.95 (1.81)	32.2 (122)	5.07 (1.54)	
2 (50)	Factory or Minimum	13.7 (51.8)	1.31 (.4)	9.4 (35.6)	.9 (.27)	105 (398)
	Maximum	56.4 (214)	5.39 (1.64)	47.4 (179)	4.53 (1.38)	
2½ (65)	Factory or Minimum	17.9 (67.8)	1.20 (.36)	12.1 (45.8)	.81 (.25)	149 (565)
	Maximum	71.3 (270)	4.78 (1.46)	59.2 (224)	3.97 (1.21)	
3 (80)	Factory or Minimum	24.2 (91.6)	1.05 (.32)	16.4 (62.1)	.71 (.22)	230 (872)
	Maximum	89 (337)	3.87 (1.18)	72.5 (274)	3.15 (.96)	
4 (100)	Factory or Minimum	35.3 (134)	.89 (.27)	27 (102)	.68 (.21)	397 (1505)
	Maximum	118 (446)	2.89 (.91)	105 (397)	2.64 (.8)	
5 (125)	Factory or Minimum	48.6 (184)	.78 (.24)	37.4 (142)	.6 (.18)	654 (2479)
	Maximum	178 (674)	2.86 (.87)	160 (606)	2.57 (.78)	
6 (150)	Factory or Minimum	60.3 (228)	.67 (.20)	46.8 (177)	.52 (.16)	900 (3411)
	Maximum	245 (927)	2.72 (.83)	225 (852)	2.5 (.76)	

Values are ± 10%

NOTE: DO NOT USE LIQUID FLOW SWITCHES ON SYSTEMS WITH FLOW VELOCITY GREATER THAN 10 FEET (3M) PER SECOND.

STEP 1 - Paddle Sizing

Determine the correct paddle length for your installation from the chart below.

Pipe Size		Paddle (Standard Length)		Trim to Length	
in.	(mm)	in.	(mm)	in.	(mm)
1	(25)	1	(25)	N/A	
1 1/4	(32)	2	(25)	1 1/4	(32)
1 1/2	(40)	2	(51)	1 1/2	(38)
2	(50)	2	(51)	1 5/8	(41)
2 1/2	(65)	3	(76)	2 1/4	(57)
3	(80)	3	(76)	2 5/8	(67)
4	(100)	6	(152)	3 5/8	(92)
6	(150)	6	(152)	5 5/8	(143)
8+	(200+)	6	(152)	N/A	

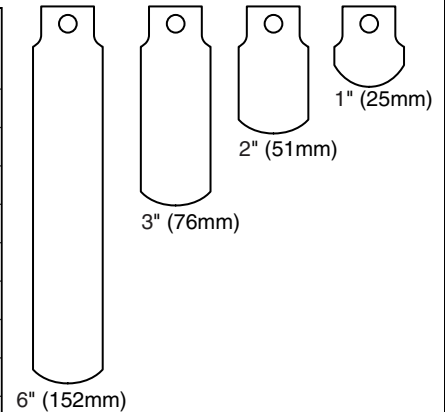

NOTE: All models include 4 paddles as shown.

- a. If the paddle must be trimmed, measure the paddle from the center of large hole (A) to the length required. Using non-serrated tin snips, trim the end (B) on a curve just like the paddle was originally cut.

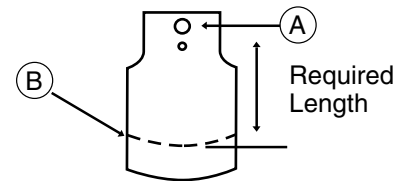

- b. If the flow rate in the pipe exceeds the maximum adjustment on the Flow Switch use the following formula to change the paddle lengths.

$$\text{Paddle Length} = \frac{K}{\text{Flow Rate (GPM)}}$$

NOTE: If trimming the paddle for a no-flow action make sure there is enough flow to activate switch.

Series FS8-W "K" Factor

Pipe Size NPT in. (mm)	Flow Maximum Adjustment	No-Flow Maximum Adjustment
2 (50)	118.5	99.5
3 (80)	278.0	227.0
4 (100)	442.0	391.0
5 (125)	847.0	762.0
6 (150)	1440.0	1325.0

STEP 2 - Determine the Location of the Flow Switch

- The flow switch **should be located in a horizontal section of pipe** where there is a straight horizontal run of at least 5 pipe diameters on each side of the flow switch. The flow switch may be installed in a vertical pipe if the flow is in the upward direction.
- The flow switch **must be installed in the upright position** as shown with arrow mark on side of casting in the same direction as fluid will flow.
- Some system conditions that require more than 5 pipe diameters are high viscosity fluid and high fluid velocity.
- The flow switch must be installed in the pump suction piping when spring-loaded check valves and/or other close coupled accessories are installed in the pump discharge piping.

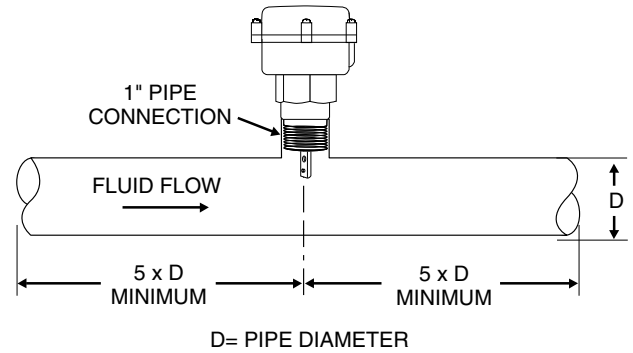

- a. The flow switch must be installed in the pipe using a threaded tee connection or welding fitting of minimum length such as a half coupling. Use a

face or hex bushing to reduce the tee outlet to 1" pipe thread if a reduced tee outlet thread size fitting is not available.

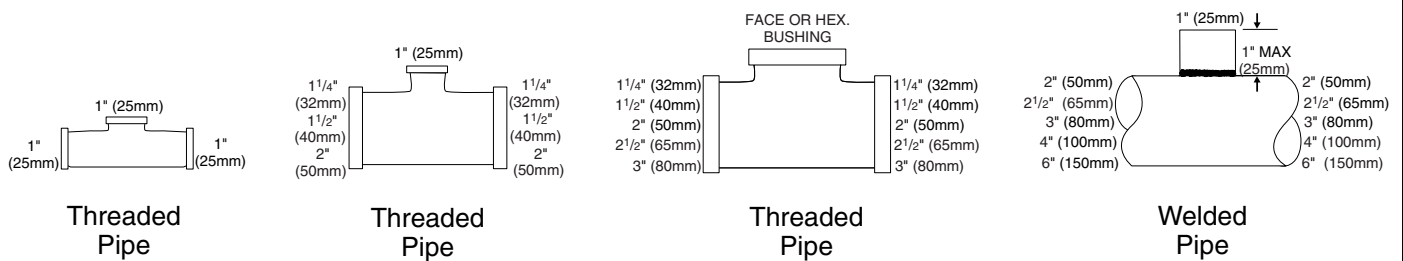

- b. When installing brazed/soldered copper pipe, size the threaded adapter to ensure the paddle arm extends into the main run of the pipe.

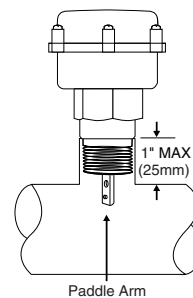

CORRECT

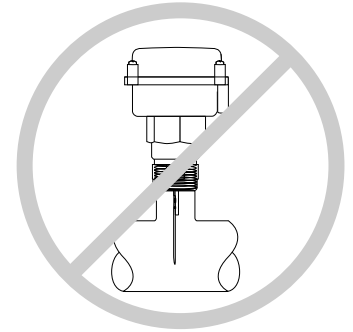

INCORRECT

STEP 3 - Connecting the Flow Switch to Pipe

- a. Insert the 8/32 x 5/16" screw through lock washer, new larger washer and paddle. Attach screw to the paddle arm and tighten to a torque of approximately 12-16 lb•in (1.36-1.81 Nm).

NOTE: If two paddles are being installed, they must be stacked one on top of the other with the longer paddle first in line to the flow.

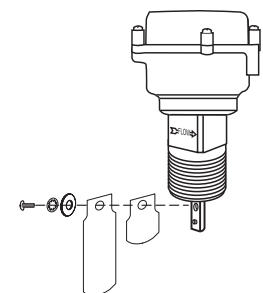

- b. Apply pipe sealing compound or Teflon® tape to the flow switch pipe threads.

NOTE: Do not apply sealant to first threads as this switch is grounded (earthed) via the pipe mounting.

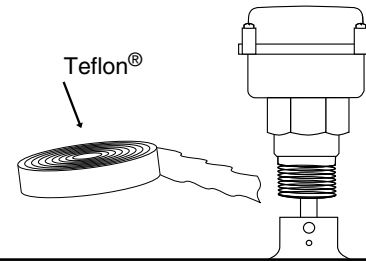

- c. Insert the flow switch into the pipe tee. Turn the flow switch two (2) or three (3) revolutions clockwise until tight. Do not put excessive force on cover when turning.

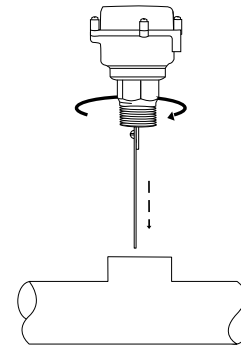

- d. Place a 1 3/8" open end wrench on flow switch body to tighten to final position. Final position is with arrow on body aligned in the same direction as liquid flow.

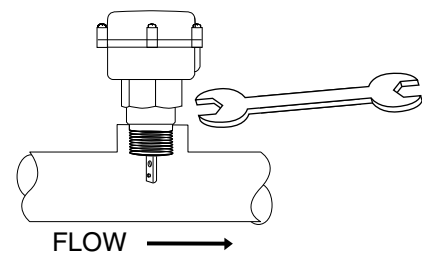

STEP 4 - Electric Wire Connections

WARNING



- To prevent electrical shock, turn off the electrical power before making electrical connections.
 - To prevent an electrical fire or equipment damage, electrical wiring insulation must have a rating of 167°F (75°C) if the liquid's temperature exceeds 180°F (82°C).
 - To prevent electrocution, when the electrical power is connected to the flow switch, do not touch the terminals.
 - Make sure flow switch electrical cover is secured before turning on electric power.
- Failure to follow this warning could cause property damage, personal injury or death.

a. Cover Removal and Installation Procedure

- Using a flathead screwdriver, unscrew the four cover screws and remove the electrical connection cover (A).
- Place electrical connection cover on the flow switch and insert four cover screws. Tighten the screws to 10 lb•in (1.13 N•m).

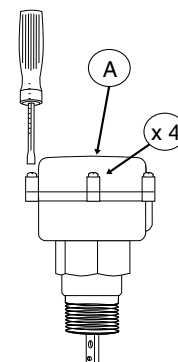

b. Electrical Conduit Connection

- Connect electric conduit to flow switch electrical enclosure.
- Follow accepted electrical practices when installing fittings and making connections.
- Refer to and follow local codes and standards when selecting the types of electrical fittings and conduit to connect to flow switch.

c. Determine which switch action is required for the flow switch.

- “Flow” means that the switch will close circuit C.-N.O. and open circuit C.-N.C. when flow rate is increased above setpoint of flow switch.
- “No Flow” means that the switch will open circuit C.-N.O. and close circuit C.-N.C. when flow rate is decreased below setpoint of flow switch.

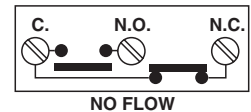
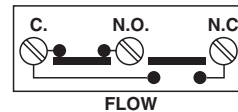

d. Based upon the mode of operation (“Flow” or “No-Flow”) required, complete the appropriate steps to connect wires to flow switch. Use a Phillip’s head screwdriver to loosen and tighten switch terminal screws when attaching wires.

For “Flow” Mode of Operation (Fig. 1)

If the flow switch will be used to actuate a signal, alarm or other device when **flow** occurs, connect the wire from that device to the “N.O.” contact. Connect the “Hot” power supply wire to “C” terminal.

For “No Flow” Mode of Operation (Fig. 2)

If the flow switch will be used to actuate a signal, alarm or other device when **no flow** occurs, connect the wire from that device to the “N.C.” contact. Connect the “Hot” power supply wire to “C” terminal.

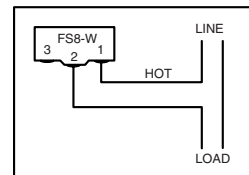
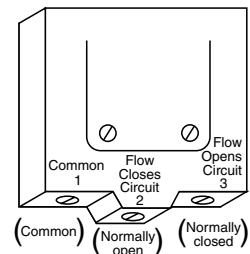
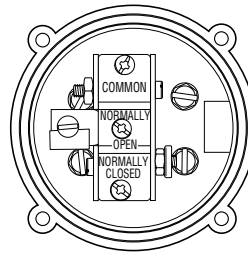

Fig. 1

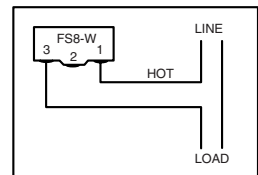
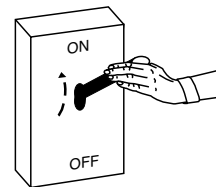

Fig. 2

STEP 5 - Testing

- Place cover on flow switch and turn on power. Initiate fluid flow through the system. Observe the device being activated by the flow switch to determine if device is operating as required.
- Turn off fluid flow to determine if device is operating as required.
- Repeat initiating and turning off fluid flow several times to test flow switch and device for proper operation.
 - If operating as required, put system into service.
 - If not operating as required, Flow Switch may need to be adjusted.



STEP 6 - Adjustment

Adjustment is necessary only if required flow/no flow setpoints are **above** factory set minimum.

- a. Turn off power. Remove electric enclosure cover.
- b. Turn the adjusting screw clockwise to increase setpoint.

IMPORTANT: Do not attempt to lower flow switch setpoint from original factory minimum setting. Lowering (turning adjusting screw counterclockwise) the setpoint from original factory setting may cause erratic flow switch operation.

- c. Place cover on flow switch and turn on power.
- d. Test the operation of the flow switch after each adjustment.

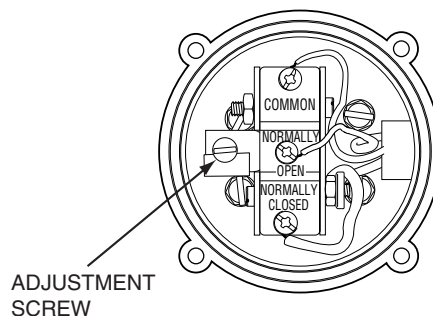

MAINTENANCE

SCHEDULE:

- **Inspect paddle annually. Turbulent or high flow velocity conditions may require more frequent inspection and/or replacement.**
- **Replace paddle if damaged or showing signs of wear.**
- **Replace flow switch every 5 years or 100,000 cycles, whichever occurs first.**

TROUBLESHOOTING

Problem:

1. Flow Switch Does Not Operate

Solution:

- a. Make sure power has been turned on to device and flow switch.
- b. Verify that flow rate is high enough for flow switch to activate. Measure flow rate and match with velocities shown in flow rate chart.
- c. Check to see if paddle moves freely. Some system piping disassembly may be required.

2. Flow Switch Operates Erratically

Solution:

- a. Flow switch may be located in an area of high turbulence causing paddles to flutter.
- b. Adjustment screw may have been turned below original factory setpoint. Verify that flow rate is high enough for flow switch to activate. Measure flow rate and match with velocities shown in flow rate chart.
- c. Check to see if paddle moves freely. Some system piping disassembly may be required.

3. Flow Switch Does Not Deactivate

Solution:

- a. Check to see if paddle moves freely. Some system piping disassembly may be required.
- b. Measure flow rate and match with velocities shown in flow rate chart. Flow switch must prove flow before it can indicate no flow.