

PIR Ready SE7300 Series

24 VAC Low Voltage Fan Coil
Terminal Equipment Controller



Installation Guide

For Commercial and Lodging HVAC
Fan Coil Applications



CONTENTS

Installation	2
Location	2
Installation	2
Configurable BI/UI inputs overview	3
Model Chart	6
Network ready	6
Terminal, Identification and Function	7
Terminal identification	7
Wiring	7
Main outputs wiring	8
Typical applications	9
Remote sensor accessories	12
Configuring and Status Display Instructions	14
Status display	14
User Interface	16
Local keypad interface	16
Dual occupied setpoints adjustment	17
Single occupied setpoints adjustment	17
Unoccupied and stand-by setpoints adjustments	17
Mode button menu sequence	17
Installer Configuration Parameter Menu	19
Configuration interface	19
Specifications	33
Drawing & Dimensions	34



INSTALLATION

Remove the security screw on the bottom of the Fan Coil Terminal Equipment Controller cover.

- Open unit by pulling on the bottom side of Fan Coil Terminal Equipment Controller (Fig. 1).
- Remove wiring terminals from sticker.
- Please read the FCC ID and IC label installed in the cover upon removal of cover for the wireless products.

Location

1. Should not be installed on an outside wall.
2. Must be installed away from any direct heat source.
3. Should not be installed near an air discharge grill.
4. Should not be affected by direct sun radiation.
5. Nothing should restrict vertical air circulation to the Fan Coil Terminal Equipment Controller.

Installation

1. Swing open the Fan Coil Terminal Equipment Controller PCB to the left by pressing the PCB locking tabs (Fig. 2).
2. Pull out cables 6" out from the wall.
3. Wall surface must be flat and clean.
4. Insert cable in the central hole of the base.
5. Align the base and mark the location of the two mounting holes on the wall. Install proper side of base up.
6. Install anchors in the wall.
7. Insert screws in mounting holes on each side of the base (Fig. 2).
8. Gently swing back the circuit board on the base and push on it until the tabs lock it.
9. Strip each wire 1/4 inch from end.
10. Insert each wire according to wiring diagram.
11. Gently push excess wiring back into hole (Fig. 3).
12. Re-Install wiring terminals in their correct locations (Fig. 3).

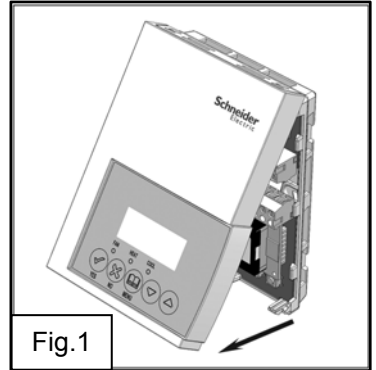

Fig.1

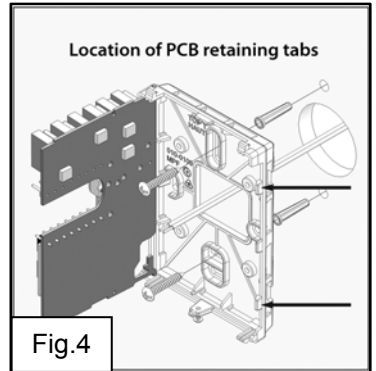

Fig.4

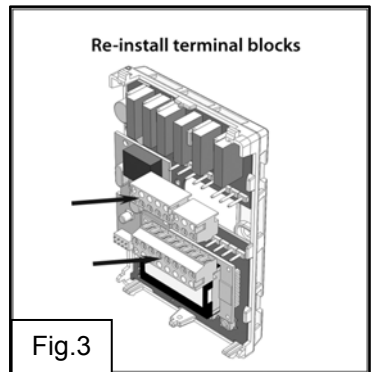

Fig.3

13. Re-install the cover (top side first) and gently push extra wire length back into the hole in the wall.
14. Install security screw.



- If replacing an old Terminal Equipment Controller, label the wires before removal of the old Terminal Equipment Controller.
 - Electronic controls are static sensitive devices. Discharge yourself properly before manipulation and installing the Terminal Equipment Controller.
 - Short circuit or wrong wiring may permanently damage the Terminal Equipment Controller or the equipment.
 - Anti-short cycling can be set to 0 minutes for equipment that posses their own anti cycling timer. Do not use that value unless the equipment is equipped with such internal timer. Failure to do so can damage the equipment.
- All SE7000 series Terminal Equipment Controllers are to be used only as operating controls. Whenever a control failure could lead to personal injury and/or loss of property, it becomes the responsibility of the user to add safety devices and/or alarm system to protect against such catastrophic failures.

CONFIGURABLE BI/UI INPUTS OVERVIEW

Binary input #1 can be configured for the following functions:

1. **(None): No function will be associated with the input**
2. **(Rem NSB):** remote NSB timer clock input. The scheduling will now be set as per the binary input. It provides low cost setback operation via a dry contact
Contact opened = Occupied
Contact closed = Unoccupied
3. **(Motion NO) and (Motion NC):** Advanced PIR occupancy functions using a normally open (NO) or normally closed (NC) remote PIR motion sensor. Occupancy mode is now set as per applied PIR function and configuration. Application information and examples are available on document: *APP-PIR-Guide-Exx*. This document will provide the installers and system designers with detailed examples on applications, parameter configuration information, sequence of operation, troubleshooting and diagnostic help required for the proper usage of the PIR accessory covers
4. **(Window) EMS:** Forces the system to disable any current heating or cooling action by the Terminal Equipment Controller. The mode stays the same and the current setpoints are the same occupied setpoints. Only the outputs are disabled. There is a Door or Window alarm displayed on the Terminal Equipment Controller to indicate to the local tenant that the door or window needs to be closed for cooling or heating to resume. Use NC contact.
Contact opened = System disabled with local Window alarm
Contact closed = System enabled

Binary input #2 can be configured for the following functions:

1. **(None):** No function will be associated with the input
2. **(Door Dry) Door contact & Motion detector:** This configuration is only functional if binary input #1 is set to **Motion NO** or **Motion NC** or a **PIR accessory cover** is used. With this sequence enabled, the occupancy is now dictated through those 2 inputs. Any motion detected will set the zone to occupied status. The zone will remain permanently in occupied mode until the door contact switch opens momentarily. The Terminal Equipment Controller will then go in stand-by mode. If more movements are detected, the occupied mode will resume. While the door is opened, any movements detected by the remote PIR sensor or the PIR accessory cover will be ignored. Use a Normally Closed contact switching device.
 Contact opened = Door opened
 Contact closed = Door closed
3. **(RemOVR):** temporary occupancy remote override contact. This function disables the central button override function on the Terminal Equipment Controller. The override function is now controlled by a manual remote momentarily closed contact. When configured in this mode, the input operates in a toggle mode. It is now possible to toggle between unoccupied & occupied setpoints for the amount of time set by parameter (TOccTime) temporary occupancy time.
4. **(Filter):** a backlit flashing Filter alarm will be displayed on the Terminal Equipment Controller LCD screen when the input is energized. It can be tied to a differential pressure switch that monitor filters
 Contact opened = No alarm
 Contact closed = Alarm displayed
5. **(Service):** a backlit flashing Service alarm will be displayed on the Terminal Equipment Controller LCD screen when the input is energized. It can be tied in to the AC unit control card, which provides an alarm in case of malfunction.
 Contact opened = No alarm
 Contact closed = Alarm displayed

Universal input #3 can be configured for the following functions:

1. **(None):** No function will be associated with the input
2. **(COC/NH) Change over dry contact. Normally Heat:** Used for hot or cold air or water change over switching in 2 pipe systems.
 Contact closed = Cold air / water present
 Contact opened = Hot air / water present
Only used and valid if system is setup as 2.0. Parameter (Out1Conf) set as 2.0.
3. **(COC/NC) Change over dry contact. Normally Cool:** Used for hot / cold air / water change over switching in 2 pipe systems.
 Contact closed = Hot air / water present
 Contact opened = Cold air / water present

Only used and valid if system is setup as 2.0. Parameter (Out1Conf) set as 2.0.

4. **(COS) Change over analog sensor:** Used for hot / cold air / water change over switching in 2 pipe systems.

Only used and valid if system is setup as 2.0. Parameter (Out1Conf) set as 2.0.

If temperature is > 77 °F = Hot air / water present

If temperature is < 75 °F = Cold air / water present

5. **(SS) Supply air sensor monitoring:** Used for supply air temperature monitoring.

Only used for network reporting of the supply air temperature. Has no internal function in the Terminal Equipment Controller.

MODEL CHART

Product Matrix Selector For The SE7300 Series FCU Controllers

Please refer to the following matrix when ordering controllers:

SE73 5 5 C 5545E

Step 1 MODEL	Step 2 HUMIDITY SENSOR AND CONTROL	Step 3 CENTER KEY FUCTION	Step 4 COMPATIBILITY	Step 5 PIR OPTIONS	Step 6 COMMUNICATION OPTIONS
	0 No humidity sensor	0 Override, for commercial applications	C Floating or on-off digital control outputs	50 PIR ready but PIR cover not included	B BACnet MS/TP
	5 Internal humidity sensor	5 °C/°F, for hotels/ lodging applications	F Analog 0-10 Vdc control outputs	55 Factory assembled with PIR cover	E Echelon
					W Zigbee wireless
					NONE Network Ready

EXAMPLE:

SE73 5 5 C 5045B

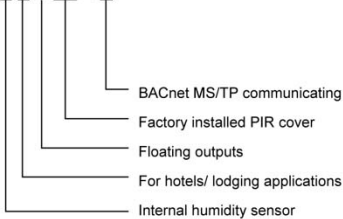

Network ready

- All Schneider-Electric SE7300 series Terminal Equipment Controllers are designed for stand-alone (Network Ready) operation.
- They can be fully integrated into your choice of automation systems using the available communication adapter options.
- If required, stand-alone (Network Ready) Terminal Equipment Controllers can be field retrofitted with the following communication adapters:
 - VCM7000V5045W, Terminal Equipment Controller wireless communication adapter
 - VCM7300V5045B, Terminal Equipment Controller BACnet® MS-TP communication adapter
 - VCM7300V5045E, Terminal Equipment Controller Lontalk® communication adapter

TERMINAL, IDENTIFICATION AND FUNCTION

Terminal identification

Schneider Part Numbers	SE73xxC5x45(x)	Viconics Number	SE73xxF5x45(x)
Description / Application	2 & 4 Pipe Floating 2 & 4 Pipe On/Off	Description / Application	2 & 4 Pipe Analog
Internal Temperature	X	Internal Temperature	X
Internal Humidity	Model Dependent	Internal Humidity	Model Dependent
1- High Fan Speed	Fan-H	1- High Fan Speed	Fan-H
2- Medium Fan Speed	Fan-M	2- Medium Fan Speed	Fan-M
3- Low Fan Speed	Fan-L	3- Low Fan Speed	Fan-L
4- 24 V~ Hot	24 V~ Hot	4- 24 V~ Hot	24 V~ Hot
5- 24 V~ Com	24 V~ Com	5- 24 V~ Com	24 V~ Com
6- Aux BO 5	BO 5-Aux	6- Aux BO 5	BO 5-Aux
7- Aux BO 5	BO 5-Aux	7- Aux BO 5	BO 5-Aux
8- BO 3 Open Heat	BO 3		
9- BO 4 Close Heat	BO 4	9- AO 2 Heat	AO 2
10- BO 1 Open Cool	BO 1	10- AO 1 Cool	AO 1
11- BO 2 Close Cool	BO 2	Not used Blank	Blank
12- BI #1	BI 1	12- BI #1	BI 1
13- RS	RS	13- RS	RS
14- Scm	Scm	14- Scm	Scm
15- BI #2	BI 2	15- BI #2	BI 2
16- UI #3 COS / COC / SS	UI 3	16- UI #3 COS / COC / SS	UI 3

Wiring

Power & Fan (All models)

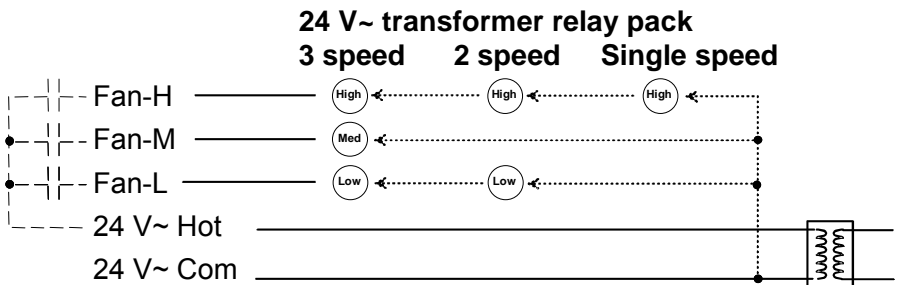

Auxiliary output (All models)

- Dry contact to end device 24 V~ maximum

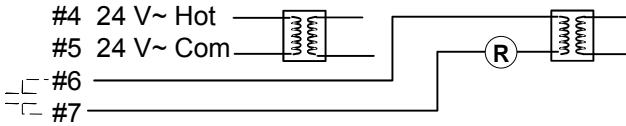

- 24 VAC power to relay

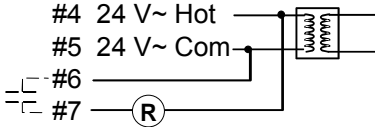

Remote inputs (All models)

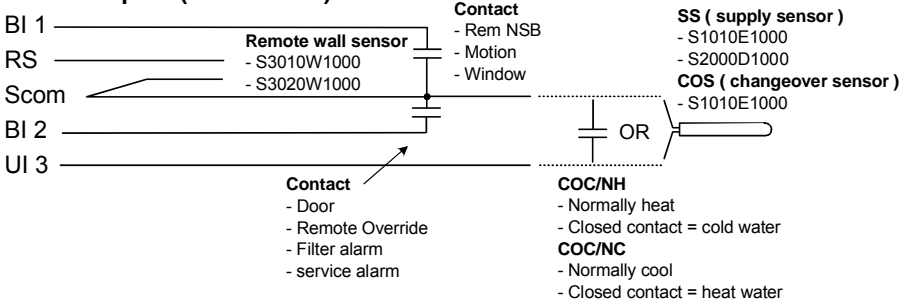

Main outputs wiring

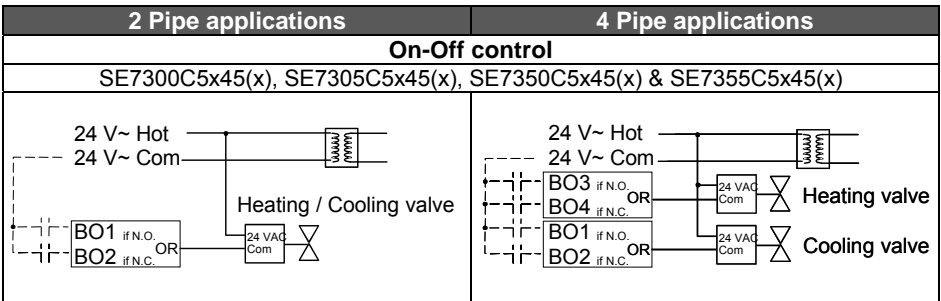

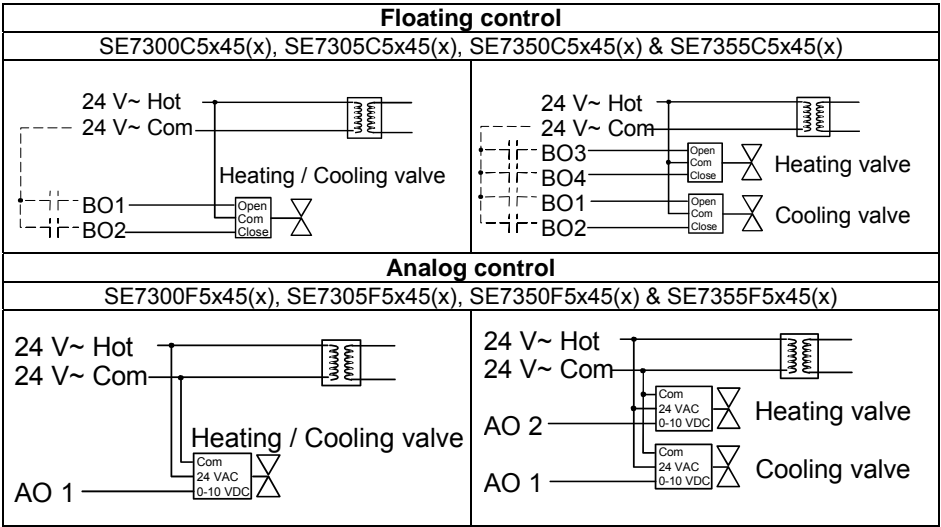

Typical applications

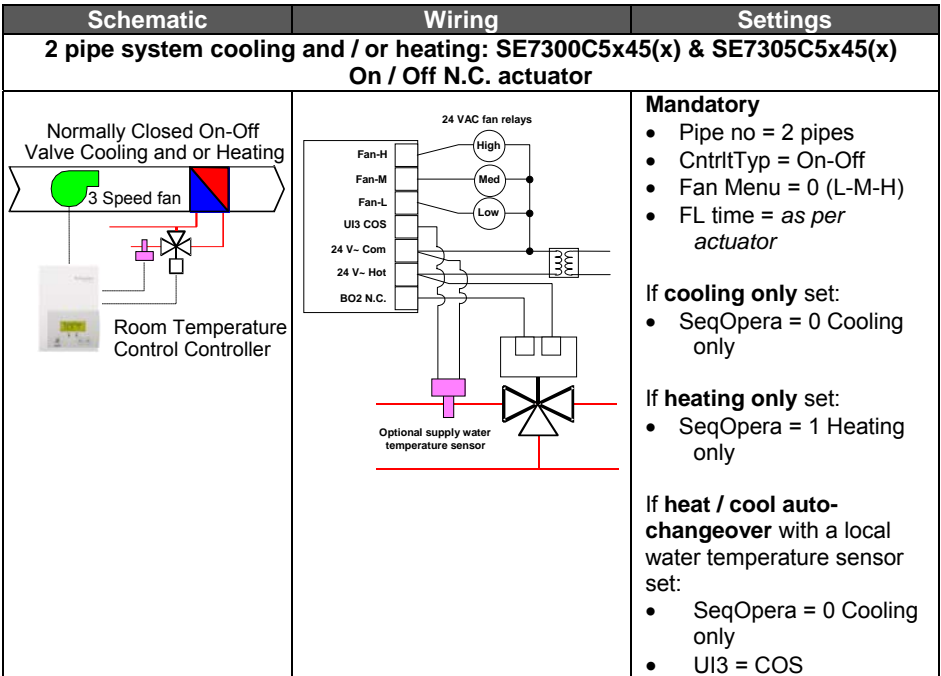

2 pipe system cooling and or heating: SE7300C5x45(x) & SE7305C5x45(x) Floating actuator

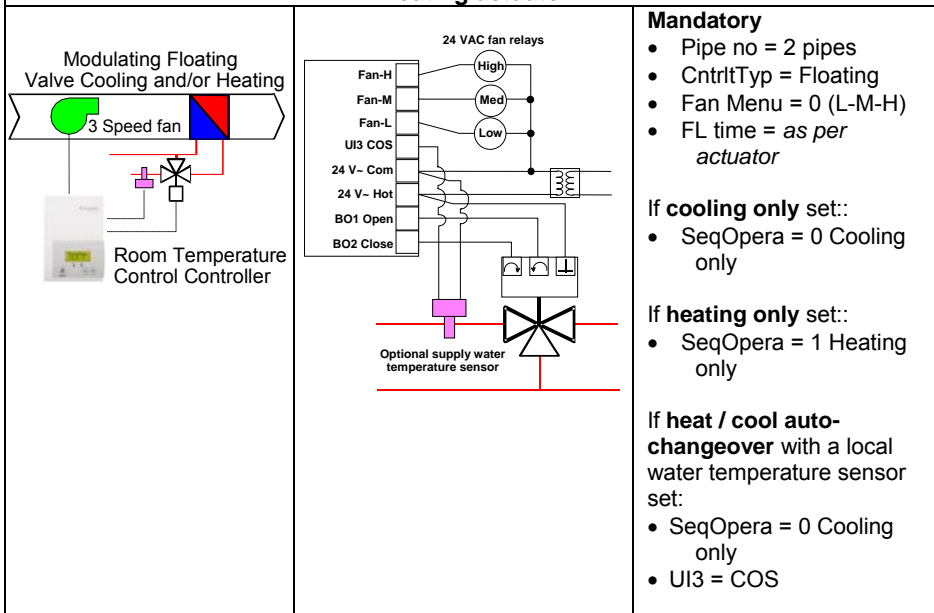

2 pipe system cooling and or heating: SE7300F5x45(x) & SE7305F5x45(x) Analog actuator

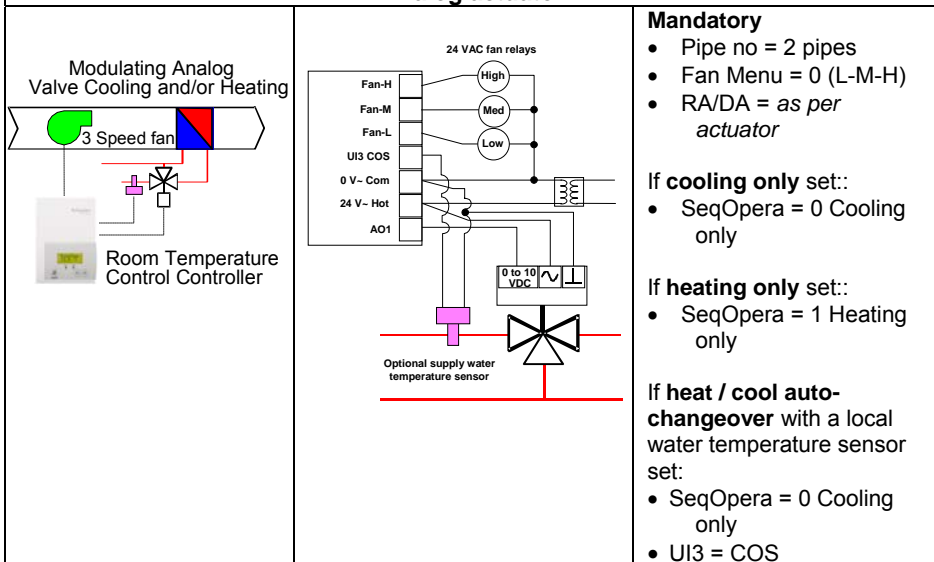

4 pipe system cooling and heating: SE7300C5x45(x) & SE7305C5x45(x) On / Off N.C. actuators

Normally Closed On-Off Valve Cooling and Heating

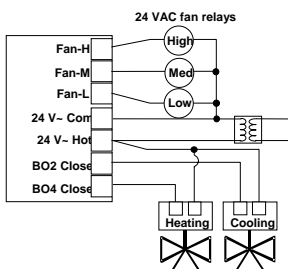
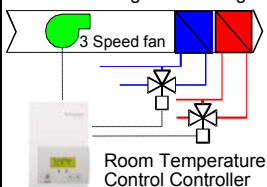

Mandatory

- Pipe no = 4 pipes
- CntrItTyp = On-Off
- Fan Menu = 0 (L-M-H)
- FL time = as per actuator
- SeqOpera = 4 Cool/Heat

4 pipe system cooling and heating: SE7300C5x45(x) & SE7305C5x45(x) Floating actuators

Modulating Floating Valve Cooling and Heating

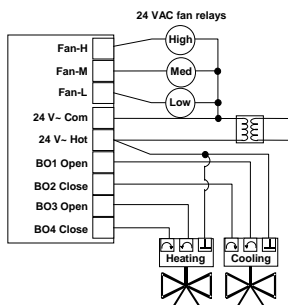
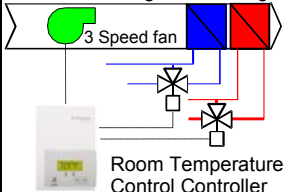

Mandatory

- Pipe no = 4 pipes
- CntrItTyp = Floating
- Fan Menu = 0 (L-M-H)
- FL time = as per actuator
- SeqOpera = 4 Cool/Heat

4 pipe system cooling and heating: SE7300F5x45(x) & SE7305F5x45(x) Analog actuators

Modulating Analog Valve Cooling and Heating

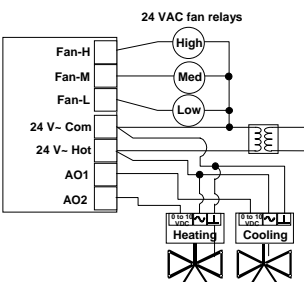
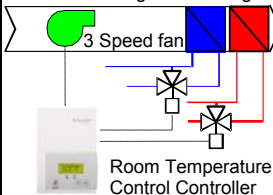

Mandatory

- Pipe no = 4 pipes
- Fan Menu = 0 (L-M-H)
- RA/DA = as per actuator
- SeqOpera = 4 Cool/Heat

2 pipe system cooling or heating with reheat: SE7300C5x45(x) & SE7305C5x45(x) Floating actuator

Modulating Floating Valve Cooling and/or Heating

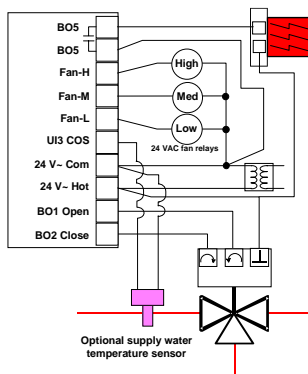
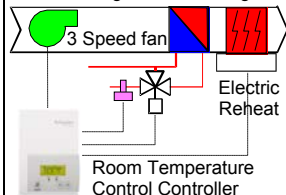

Mandatory

- Pipe no = 2 pipes
- CntrtTyp = Floating
- Fan Menu = 0 (L-M-H)
- FL time = as per actuator
- SeqOpera = 2 Cool/Reheat
- UI3 = COS

Remote sensor accessories

Model no.	Description
S3010W1000	Wall mounted temperature sensor
S3020W1045	Wall mounted temperature sensor with override button and occupancy status LED



Remote mount temperature sensors use 10K type 2 NTC thermistors.

S3020W1045 WALL MOUNTED SENSOR

Features:

- Each sensor can be configured for various averaging combinations
- Optional occupancy led
- Optional override key

Wiring example of single remote room sensor:

SE3000 Series
Thermostat

S3020W1000
Remote wiring 1 sensor
S2=On, S3=On

S3010W1000
Remote wiring 1 sensor
S2=On, S3=On

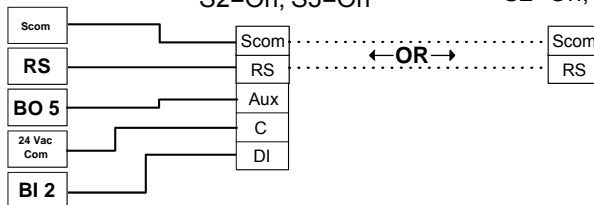

Dip switch setting for:
1 sensor

ON S2-1 = ON
OFF S2-2 = ON

Wiring examples of 2 remote room sensors for averaging applications:

SE7300 Series Thermostat 1 x S3010W1000 and 1 x S3020W1000
Remote wiring 2 sensors
S1=On, S2=Off

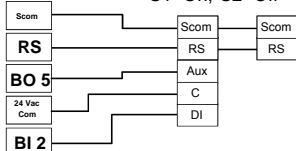

SE7300 Series Thermostat 2 x S3020W1000
Remote wiring 2 sensors
S2=On, S3=Off

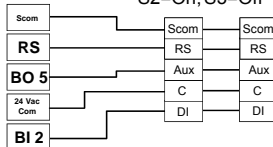

SE7300 Series Thermostat 2 x S3010W1000
Remote wiring 2 sensors
S2=On, S3=Off

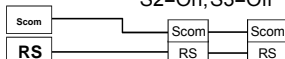

Notes for averaging applications:

- S3010W1000 and S3020W1045 can be mixed matched.
- S3010W1000 and S3020W1045 are to be wired in parallel.
- Respect the dip switch setting in each remote sensor.

Dip switch setting for: S2-1 = OFF
S2-2 = ON
2 sensors

Wiring examples of 3 remote room sensors for averaging applications:

SE7300 Series Thermostat 2x S3010W1000 and 1 x S3020W1000
Remote wiring 3 sensors
S2=Off, S3=Off

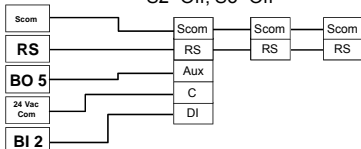

SE7300 Series Thermostat 3x S3010W1000
Remote wiring 3 sensors
S2=Off, S3=Off

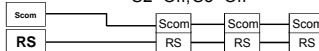

Dip switch setting for: S2-1 = OFF
S2-2 = OFF
3 sensors

Temperature vs. resistance chart for 10 Kohm NTC thermistor ($R_{25^{\circ}\text{C}} = 10\text{K}\Omega \pm 3\%$, $B_{25/85^{\circ}\text{C}} = 3975\text{K} \pm 1.5\%$)

°C	°F	Kohm	°C	°F	Kohm	°C	°F	Kohm	°C	°F	Kohm	°C	°F	Kohm
-40	-40	324.3197	-20	-4	94.5149	0	32	32.1910	20	68	12.4601	40	104	5.3467
-35	-31	234.4009	-15	5	71.2430	5	41	25.1119	25	77	10.0000	45	113	4.3881
-30	-22	171.3474	-10	14	54.1988	10	50	19.7390	30	86	8.0694	50	122	3.6202
-25	-13	126.6109	-5	23	41.5956	15	59	15.6286	35	95	6.5499	55	131	3.0016

CONFIGURING AND STATUS DISPLAY INSTRUCTIONS

Status display

The SE7300 series wall-mount Terminal Equipment Controller features a two-line, eight-character display. There is a low level backlight level that is always active and can only be seen at night.

When left unattended, the Terminal Equipment Controller has an auto scrolling display that shows the actual status of the system. There is an option in the configuration menu to lockout the scrolling display and to only present the room temperature and conditional outdoor temperature to the user. With this option enabled, no local status is given of mode, occupancy and relative humidity.

Each item is scrolled one by one with the back lighting in low level mode. Pressing any key will cause the back light to come on to high level. When left unattended for 10 seconds after changes are made, the display will resume automatic status display scrolling.

To turn on the back light to high level, press any key on the front panel. The back lit display will return to low level when the Terminal Equipment Controller is left unattended for 45 seconds.

Sequence of auto-scroll status display:

ROOM & HUMIDITY	SYSTEM MODE	SCHEDULE STATUS	OUTDOOR TEMPERATURE	ALARMS
x.x °C or °F XX % RH	Sys mode auto	Occupied	Outdoor x.x °C or °F	Service
If humidity display enabled	Sys mode cool	Stand-By	Network value only	Filter
RoomTemp x.x °C or °F	Sys mode heat	Unoccup	n/a	Window
If humidity display is not enabled	Sys mode off	Override	n/a	

% RH display is conditional to:

(Humidity display is model and configuration dependent)

- Model with RH sensor built in
- Display function can be enabled with RH display parameter. Displayed range is 10 to 90 % RH

Outdoor air temperature

- Display is only enabled when outdoor air temperature network variable is received.

Occupancy status

- Occupied, Stand-By, Unoccupied and Override status are displayed on the scrolling display.

Alarms

- If alarms are detected, they will automatically be displayed at the end of the scrolling status display.
- When an alarm message is displayed, the backlit screen will illuminate at the same time as the message and shut off during the rest of the status display.
- A maximum of two alarms can appear at any given time. The priority for the alarms are as follows:

Service	Indicates that there is a service alarm as per one of the configured binary inputs (B12)
Filter	Indicates that the filters are dirty as per one of the configured binary inputs (B12)
Window	Indicates that the outside window or door is opened and that the Terminal Equipment Controller has cancelled any cooling or heating action (B11)

Three status LED's on the Terminal Equipment Controller cover are used to indicate the status of the fan (any speed), a call for heat, or a call for cooling.

Fan coil models

When any of the fan speeds are ON , the FAN LED will illuminate	FAN ○
When heating & reheat is ON , the HEAT LED will illuminate	HEAT ○
When cooling is ON , the COOL LED will illuminate	COOL ○



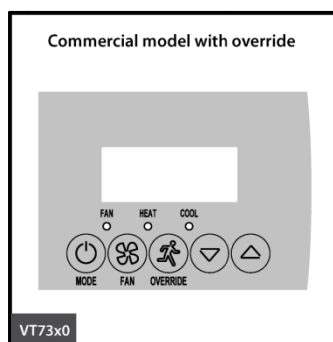



USER INTERFACE



Unoccupied mode override

An Override can be made on commercial models during an unoccupied period. If the Override option is enabled in the lockout configuration, pressing the middle override button will resume occupied setpoints for a time specified by the parameter "ToccTime".

Local keypad interface

 MODE	<ul style="list-style-type: none"> Is used to toggle between the different system modes available as per sequence and menu selected. Repetitively pressing the button will toggle between all the available modes. Available menus are dependent on selected sequence of operation.
 FAN	<ul style="list-style-type: none"> Is used to toggle between the different fan modes available as per the sequence and menu selected Repetitively pressing the button will toggle between all the available modes Available menus are dependent on selected sequence of operation and menu selected for Fan
 °F	<ul style="list-style-type: none"> Hotel and lodging applications. Toggles the local user temperature scale between °F and °C
 OVERRIDE	<ul style="list-style-type: none"> Commercial and institutional applications. Set a local unoccupied timed override to occupied mode
	<ul style="list-style-type: none"> In cooling mode only the cooling setpoint is displayed, In heating mode only the heating setpoint is displayed In auto mode, (See below)
	<ul style="list-style-type: none"> In cooling mode only the cooling setpoint is displayed, In heating mode only the heating setpoint is displayed In auto mode, (See below)

- Any setpoint change can be permanent or temporary based on configuration parameter (Setpoint Type)
- Any setpoint written through the network, will be permanent and cancel any active temporary setpoints
- Lockouts of access to certain functions is made with configuration parameter (lockout)

Dual occupied setpoints adjustment

(Local occupied setpoint adjustment when “Stp Func” = *Dual Stp*)

COOLING MODE	HEATING MODE	OFF MODE	AUTO MODE
Cool XX.X °F or °C	Heat XX.X °F or °C	No access to setpoint	<ul style="list-style-type: none"> ▪ Setpoint presented to user is the setpoint from the last action taken by the Terminal Equipment Controller or the one currently in use. ▪ If the other setpoint is the one desired, then the MODE button is used to toggle between the current displayed one and the other.
			Cool XX.X °F or °C or Heat XX.X °F or °C Toggle to (Heat or Cool)with MODE button

- Heat/Cool setpoint toggle with MODE button to be active only in AUTO mode.
- If cooling, heating or off mode is active, function is disabled.

Single occupied setpoints adjustment

(Local occupied setpoint adjustment when “Stp Func” = *Atch Stp*)

COOLING MODE	HEATING MODE	OFF MODE	AUTO MODE
Cool XX.X °F or °C	Heat XX.X °F or °C	No access to setpoint	<ul style="list-style-type: none"> ▪ Setpoint presented to user is the setpoint from the last action taken by the Terminal Equipment Controller or the one currently in use. ▪ Both heating and cooling setpoints are changed simultaneously while respecting the minimum configured deadband ▪ If the other setpoint is the one desired, then the MODE button is used to toggle between the current displayed one and the other.
			Cool XX.X °F or °C and Heat XX.X °F or °C Both heating & cooling setpoints change simultaneously Toggle from (Heat or Cool) using the system MODE button

Unoccupied and stand-by setpoints adjustments

Setting of the stand-by and unoccupied setpoints is done through the network or through configuration setup only.

Mode button menu sequence

Modes presented to the user are dependent on the sequence of operation selected.

Default mode is shown in bold when sequence of operation parameter is changed.

The available mode can only be changed through the network since there is no local mode access

Sequence of operations

SEQUENCE SELECTED	MODE MENU
0 = Cooling Only	Off - Cool
1 = Heating Only	Off - Heat
2 = Cooling With Electric Reheat	Off – Auto – Heat – Cool
3 = Heating With Electric Reheat	Off - Heat
4 = Cooling and Heating (2 modulating outputs)	Off – Auto – Heat – Cool
5 = Cooling or heating (2 modulating outputs) with reheat	Off – Auto – Heat – Cool

Available fan button menu sequences

FAN BUTTON MENU CONFIGURATION	MENU PRESENTED ARE DEPENDENT ON MODEL USED AND SEQUENCE OF OPERATION SELECTED	DEFAULT VALUE WHEN SEQUENCE TOGGLED
0 Low-Med-High	3 Speed configuration using 3 fan relays (L-M-H).	High
1 Low-High	2 Speed configuration using 2 fan relays (L-H).	High
2 Low-Med-High-Auto	3 Speed configuration with Auto fan speed mode using 3 fan relays (L-M-H-A).	High
3 Low-High-Auto	2 Speed configuration with Auto fan speed mode using 2 fan relays (L-H-A).	High
4 On-Auto	Single Speed configuration. Auto is for Fan on demand / On is On all the time.	Auto

Auto speed fan mode is also offered in heating mode applications; it will not have any effect on dehumidification. It will strictly be used for noise comfort issues.

Auto Speed Fan Mode operation for sequences 2 and 3 is dependent on Auto Fan parameter. When Auto Fan is set to:





- AS (Default) = Auto Speed during occupied periods. Fan is always on during occupied periods. Low, medium and high speeds operate on temperature offset from set point.
- AS AD = Auto Speed / Auto Demand during occupied periods.
 - Medium and high speeds operate on temperature offset from set point. Low speed operates on demand and will shut down when no demand is present.

INSTALLER CONFIGURATION PARAMETER MENU

Configuration can be done through the network or locally at the Terminal Equipment Controller.

- To enter configuration, press and hold the middle button (°C/°F or Override) for 8 seconds.
- If a password lockout is active, “Password” is prompted. Enter password value using the “up” and “down” arrows and press the middle button again to gain access to all configuration properties of the Terminal Equipment Controller. Entering a wrong password will prevent local access to the configuration menu.
- Press the same middle button repetitively to scroll between all the available parameters.
- Use the up and down key to change the parameter to the desired value.
- To acknowledge and save the new value, press the middle button again.
- The next parameter will now be displayed.

Configuration interface

 FAN	Re-starts the configuration parameter list from the beginning.
	Enters the configuration mode. Press and hold for 8 seconds.
 OVERRIDE	Pressing repetitively will individually scroll all the available parameters.
	Adjust / rotate parameter value down.
	Adjust / rotate parameter value up.

CONFIGURATION PARAMETERS DEFAULT VALUE	SIGNIFICANCE AND ADJUSTMENTS
PswrdSet Configuration parameters menu access password Default value = 0 Range is: 0 to 1000	This parameter sets a password access to prevent unauthorized access to the configuration menu parameters. A default value of “0” will not prompt a password or lock the access to the configuration menu. Range is: 0 to 1000

<p>Com Addr Terminal Equipment Controller networking address Default value = 254 Range is: 0 to 254</p>	<p>Conditional parameter to BACnet® MS-TP models SE73xxX5x45B</p> <p>Conditional parameter to Wireless models SE73xxX5x45W</p> <ul style="list-style-type: none"> ▪ For BACnet® MS-TP models, the valid range is from 1 to 127. Default value of 254 disables BACnet® communication for the Terminal Equipment Controller. ▪ For wireless models, the valid range is 0 to 254 with a maximum of 30 Terminal Equipment Controller per VWG
<p>PAN ID Personal Area Network Identification Default value = 0 Range is: 0 to 500</p>	<p>Conditional parameter to Wireless models SE73xxX5x45W</p> <p>This parameter will only appear when a wireless network adapter is present. If the Terminal Equipment Controller is installed as a stand-alone (Network Ready) unit or with a BACnet® or Echelon® adapter, this parameter will not be used or displayed.</p> <p>This parameter (Personal Area Network Identification) is used to link specific Terminal Equipment Controllers to a single specific Schneider-Electric wireless gateway (VWG) . For every Terminal Equipment Controller reporting to a gateway (maximum of 30 Terminal Equipment Controllers per gateway), be sure you set the SAME PAN ID value both on the gateway and the Terminal Equipment Controller(s).</p> <p>The default value of 0 is NOT a valid PAN ID. The valid range of available PAN ID is from 1 to 500.</p>

<p>Channel Channel selection Default value = 10 Range is: 10 to 26</p>	<p>Conditional parameter to Wireless models SE73xxX5x45W This parameter will only appear when a wireless network adapter is present. If the Terminal Equipment Controller is installed as a stand-alone (Network Ready) unit or with a BACnet® or Echelon® adapter, this parameter will not be used or displayed.</p> <p>This parameter (Channel) is used to link specific Terminal Equipment Terminal Equipment Controllers to specific Schneider-Electric wireless gateway(s) (VWG). For every Terminal Equipment Terminal Equipment Controller reporting to a gateway (maximum of 30 Terminal Equipment Controllers per gateway), be sure you set the <i>SAME</i> channel value both on the gateway and the Terminal Equipment Controller(s).</p> <p>Schneider-Electric recommends using only the usage of channels 15 and 25 only. The default value of 10 is <i>NOT</i> a valid channel. The valid range of available channel is from 11 to 26</p>
<p>Get From Terminal Equipment Controller Get From another device configuration utility Default value = 0 Range is: 0 to 254</p>	<p>Conditional parameter to Wireless models SE73xxX5x45W (is this available on this model??) Entering a MAC address enables an automatic routine that automatically fetches all the required configuration properties of the current device from another already configured device and copies the same required configured property values. If a value other than the default value of 255 is entered, user will then be prompted to exit the Configuration Menu thus leaving all other parameter configuration to be copied from the referenced Terminal Equipment Controller MAC address. Ex.: If you are currently configuring MAC12 and the settings <u>matches exactly</u> the settings of ZN MAC5, then enter 5 as the current parameter value.</p> <ul style="list-style-type: none"> ▪ If the process is successful and all required configuration properties have been copied, the value will revert back to 255 ▪ If the process is <i>NOT</i> successful and all required configuration properties have <i>NOT</i> been copied (either the reference device is <i>NOT</i> the same model number or is offline or does not exists) the value will revert back to 254 to indicate the failure of the process <p>Leaving the Get From parameter to 255 means that every configuration parameters will be set manually.</p>

BI 1

Binary input no.1
configuration

Default value = **None**

(None): No function will be associated with the input. Input can be used for remote network monitoring.

(Rem NSB): remote NSB timer clock input. The scheduling will now be set as per the binary input. It provides low cost setback operation via a dry contact

- Contact opened = Occupied
- Contact closed = Unoccupied

(Motion NO) or (Motion NC): Advanced PIR occupancy functions using a Normally Open (NO) or Normally Closed (NC) remote PIR motion sensor. Occupancy mode is now set as per applied PIR function and configuration.

Application information and examples are available in document: *APP-PIR-Guide-Exx*. This document will provide the installers and system designers with detailed examples on applications, parameter configuration information, sequence of operation, troubleshooting and diagnostic help required for the proper usage of the PIR accessory covers

(Window) EMS: Forces the system to disable any current heating or cooling action by the Terminal Equipment Controller. The mode stays the same and the current setpoints are the same Occupied setpoints. Only the outputs are disabled. There is a Door/Window alarm displayed on the Terminal Equipment Controller to indicate to the local tenant that the door/window needs to be closed for cooling or heating to resume.

- Contact opened = Window Opened
- Contact closed = Window Closed

*These settings will disable the local override function on the Terminal Equipment Controller

BI 2

Binary input no.2
configuration
Default value = **None**

(None): No function will be associated with the input

(Door Dry) Door contact & Motion detector: This configuration is only functional if binary input #1 is set to **Motion NO** or **Motion NC** or a **PIR accessory cover** is used.

With this sequence enabled, the occupancy is now dictated through those 2 inputs. Any motion detected will set the zone to occupied status. The zone will remain permanently in occupied mode until the door contact switch opens momentarily. The Terminal Equipment Controller will then go in stand-by mode. If more movements are detected, the occupied mode will resume. While the door is opened, any movements detected by the remote PIR sensor or the PIR accessory cover will be ignored. Use a Normally Closed contact switching device.

Contact opened = Door opened

Contact closed = Door closed

(RemOVR): temporary occupancy remote override contact. This function disables the central button override function on the Terminal Equipment Controller. The override function is now controlled by a manual remote momentarily closed contact. When configured in this mode, the input operates in a toggle mode.

It is now possible to toggle between unoccupied & occupied setpoints for the amount of time set by parameter (TOccTime) temporary occupancy time.

(Filter): a backlit flashing **Filter** alarm will be displayed on the Terminal Equipment Controller LCD screen when the input is energized. It can be tied to a differential pressure switch that monitor filters

Contact opened = No alarm

Contact closed = Alarm displayed





























(Service): a backlit flashing **Service** alarm will be displayed on the Terminal Equipment Controller LCD screen when the input is energized. It can be tied in to the AC unit control card, which provides an alarm in case of malfunction.

- Contact opened = No alarm
- Contact closed = Alarm displayed

<p>UI3 Universal input no.3 configuration Default value = None</p>	<p>(None): No function will be associated with the input</p> <p>(COC/NH) Change over dry contact. Normally Heat: Used for hot / cold water or air change over switching in 2 pipe systems. Contact closed = Cold water or air present Contact opened = Hot water or air present Only used and valid if system is setup as 2 pipes. Parameter (Pipe No) set as 2 pipes.</p> <p>(COC/NC) Change over dry contact. Normally Cool: Used for hot / cold water or air change over switching in 2 pipe systems. Contact closed = Hot water present Contact opened = Cold water present Only used and valid if system is setup as 2 pipes. Parameter (Pipe No) set as 2 pipes.</p> <p>(COS) Change over analog sensor: Used for hot / cold water or air change over switching in 2 pipe systems. Only used and valid if system is setup as 2 pipes. Parameter (Pipe No) set as 2 pipes. If water temperature is > 78 °F = Hot water present If water temperature is < 75 °F = Cold water present</p> <p>(SS) Supply air sensor monitoring: Used for supply air temperature monitoring. Only used for network reporting of the supply air temperature. Has no internal function in the Terminal Equipment Controller.</p>
<p>MenuScro Menu scroll Default value = On = Scroll active</p>	<p>Removes the scrolling display and displays the room temperature/humidity to the user. With this option enabled, no mode, schedule and outdoor temperature status is given.</p> <ul style="list-style-type: none"> ▪ On = Scroll active ▪ Off = Scroll not active
<p>AutoMode Enables Auto menu for Mode button Default value = On</p>	<p>Enables Auto function for the mode button For sequences 2, 4 & 5 only</p> <ul style="list-style-type: none"> ▪ On = Auto active (Off-Cool-Heat-Auto) ▪ Off = auto not active (Off-Cool-Heat)

<p>C or F Sets scale of the Terminal Equipment Controller Default value = °F</p>	<ul style="list-style-type: none"> ▪ °F for Fahrenheit scale ▪ °C for Celsius scale <p>On hotel models, this sets the default value when the Terminal Equipment Controller powers up</p>
<p>%RH disp Local %RH Display Default value = Off</p> <p>Models with Humidity sensor only</p>	<p>Conditional parameter to Humidity models VTR735xX5x45(X)</p> <p>Enables the display of humidity value below the room temperature value on the display</p> <ul style="list-style-type: none"> ▪ On = Display %RH ▪ Off = No display of %RH
<p>Lockout Keypad lockout levels Default value = 0 No lock</p>	<p>See below for levels.</p>

USER KEY FUNCTIONS

LEVEL	 MODE	 FAN	 OVERRIDE	 
0				
1				
2				
3				
4				
5				

<p>Pipe No System type installation Number of pipes Default is: 4.0 Pipes</p>	<p>Defines the type of system installed</p> <p>2.0 Pipes, will limit the number of sequences of operation available from 0 to 4</p> <p>Will enable heat or cool operation from the same output</p> <p>4.0 Pipes, can access all the sequences of operation from 0 to 2</p> <p>Will enable heat/cool operation from different output</p>
---	---

<p>CtrlTyp Control type for Triac models Default value = Floating</p>	<p>Defines the type of control output for the type of valves installed SE7350C10xx, SE7300C10xx, SE7355C10xx and SE7305C10xx only On-Off is for normally opened or normally closed 24 VAC 2 position valves Floating is for modulating 3 wires control of 24 VAC floating valves</p>	
<p>SeqOpera Sequence of operation Default value = Sequence1</p>	<p>Selects the initial sequence of operation required by the installation type and the application</p>	
	SYSTEM = 2 PIPES	SYSTEM = 4 PIPES
0 = Cooling Only	Off - Cool	0 = Cooling Only
1 = Heating Only	Off - Heat	1 = Heating Only
2 = Cooling With Electric Reheat	Off – Auto – Heat – Cool	2 = Cooling With Electric Reheat
3 = Heating With Electric Reheat	Off - Heat	3 = Heating With Electric Reheat
4 = Cooling and Heating (2 modulating outputs)	Off – Auto – Heat – Cool	4 = Cooling and Heating (2 modulating outputs)
5 = Cooling or heating (2 modulating outputs) with reheat	Off – Auto – Heat – Cool	5 = Cooling or Heating (2 modulating outputs) with reheat
	<p>For 2 Pipe output applications, the system access is limited if RUI 1 is configured for local changeover COS, COC/NC or COC/NC. The current water temperature detected by the RUI 1 then limits the system mode available for the local configuration or network write.</p> <p>For sequence 2 & 3, set PulsedHt to On to enable pulsed electric reheat applications with VR7300B & E</p>	

Fan Menu Mode button menu configuration Default is: Menu #4	Menu displayed are dependent on model used and sequence of operation selected Auto Mode operation for sequences 2 and 3 is dependent on Auto Fan parameter.
0 = Low-Med-High	3 Speed configuration using 3 fan relays (L-M-H)
1 = Low-High	2 Speed configuration using 2 fan relays (L-H)
2 = Low-Med-High-Auto	3 Speed configuration with Auto fan speed mode using 3 fan relays (L-M-H-A)
3 = Low-High-Auto	2 Speed configuration with Auto fan speed mode using 2 fan relays (L-H-A)
4 = On-Auto	Single Speed configuration. Auto is for Fan on demand / On is On all the time
DHumiLCK Dehumidification lockout Default value: On = Authorized	Conditional parameter to Humidity models VTR735xX5x45(X) Typically toggled via the network. This variable enables or disables dehumidification based on central network requirements from the BAS front end <ul style="list-style-type: none"> ▪ On = Dehumidification Authorized ▪ Off = Dehumidification Not Authorized
%RH set Dehumidification setpoint Default is 50 % RH	Conditional parameter to Humidity models VTR735xX5x45(X) Used only if dehumidification sequence is enabled: Range is: 30-95% RH.
DehuHyst Dehumidification Hysteresys Default = 5 % RH	Conditional parameter to Humidity models VTR735xX5x45(X) Humidity control hysteresis. Used only if dehumidification sequence is enabled: Range is: 2 to 20% RH.
DehuCool Maximum Dehumidification Cooling output Default = 100 %	Conditional parameter to Humidity models VTR735xX5x45(X) Maximum cooling valve position when dehumidification is enabled. This can be used to balance smaller reheat loads installed relative to the capacity of the cooling coil. Range is: 20 to 100 %.
St-By TM Stand-by Timer value Default = 0.5 hours	Time delay between the moment when the PIR sensor detected the last movement in the area and the time when the Terminal Equipment Controller stand-by mode and setpoints become active. Range is: 0.5 to 24.0 hours in 0.5hr increments.

<p>Unocc TM Unoccupied Timer value Default = 0.0 hours</p>	<p>Time delay between the moment when the Terminal Equipment Controller toggles to stand-by mode and the time when the Terminal Equipment Controller unoccupied mode and setpoints become active. The factory value or 0.0 hours: Setting this parameter to its default value of 0.0 hours disables the unoccupied timer. This prevents the Terminal Equipment Controller to drift from stand-by mode to unoccupied mode when PIR functions are used Range is: 0.0 to 24.0 hours in 0.5hr increments.</p>
<p>St-By HT Stand-by heating setpoint Default value = 69 °F</p>	<p>The value of this parameter should reside between the occupied and unoccupied heating setpoints and make sure that the difference between the stand-by and occupied value can be recovered in a timely fashion when movement is detected in the zone. Stand-by heating setpoint range is: 40 to 90 °F (4.5 to 32.0 °C)</p>
<p>St-By CL Stand-by cooling setpoint limit Default value = 78 °F</p>	<p>The value of this parameter should reside between the occupied and unoccupied cooling setpoints and make sure that the difference between the stand-by and occupied value can be recovered in a timely fashion when movement is detected in the zone. Stand-by cooling setpoint range is: 54 to 100 °F (12.0 to 37.5 °C)</p>
<p>Unocc HT Unoccupied heating setpoint Default value = 62 °F</p>	<p>Unoccupied heating setpoint range is: 40 to 90 °F (4.5 to 32.0 °C)</p>
<p>Unocc CL Unoccupied cooling setpoint limit Default value = 80 °F</p>	<p>Unoccupied cooling setpoint range is: 54 to 100 °F (12.0 to 37.5 °C)</p>
<p>Heat max Maximum heating setpoint limit Default value = 90 °F (32 °C)</p>	<p>Maximum occupied & unoccupied heating setpoint adjustment. Heating setpoint range is: 40 to 90 °F (4.5 to 32.0 °C)</p>
<p>Cool min Minimum cooling setpoint limit Default value = 54 °F (12 °C)</p>	<p>Minimum occupied & unoccupied cooling setpoint adjustment. Cooling setpoint range is: 54 to 100 °F (12.0 to 37.5 °C)</p>

<p>Pband Proportional band setting Default = 3</p>	<p>Adjust the proportional band used by the Terminal Equipment Controller PI control loop.</p> <p> Note that the default value of 3.0 °F (1.2 °C) gives satisfactory operation in most normal installation cases. The use of a proportional band different than the factory one is normally warranted in applications where the Terminal Equipment Controller location is problematic and leads to unwanted cycling of the unit. A typical example is a wall mounted unit where the Terminal Equipment Controller is installed between the return and supply air feeds and is directly influenced by the supply air stream of the unit.</p> <table border="1" data-bbox="426 500 948 786"> <thead> <tr> <th>VALUE</th> <th>°F SCALE PBAND</th> <th>°C SCALE PBAND</th> </tr> </thead> <tbody> <tr> <td>3</td> <td>3 F</td> <td>1.2 C</td> </tr> <tr> <td>4</td> <td>4 F</td> <td>1.7 C</td> </tr> <tr> <td>5</td> <td>5 F</td> <td>2.2 C</td> </tr> <tr> <td>6</td> <td>6 F</td> <td>2.8 C</td> </tr> <tr> <td>7</td> <td>7 F</td> <td>3.3 C</td> </tr> <tr> <td>8</td> <td>8 F</td> <td>3.9 C</td> </tr> <tr> <td>9</td> <td>9 F</td> <td>5.0 C</td> </tr> <tr> <td>10</td> <td>10 F</td> <td>5.6 C</td> </tr> </tbody> </table>	VALUE	°F SCALE PBAND	°C SCALE PBAND	3	3 F	1.2 C	4	4 F	1.7 C	5	5 F	2.2 C	6	6 F	2.8 C	7	7 F	3.3 C	8	8 F	3.9 C	9	9 F	5.0 C	10	10 F	5.6 C
VALUE	°F SCALE PBAND	°C SCALE PBAND																										
3	3 F	1.2 C																										
4	4 F	1.7 C																										
5	5 F	2.2 C																										
6	6 F	2.8 C																										
7	7 F	3.3 C																										
8	8 F	3.9 C																										
9	9 F	5.0 C																										
10	10 F	5.6 C																										
<p>Set Type Temporary setpoint enable Default is : Permnet</p> <p>Enables temporary setpoints feature to any change of occupied or unoccupied setpoint.</p>	<p>Temporar: (temporary) Local changes to the heating or cooling setpoints by the user are temporary. They will remain effective for the duration specified by "ToccTime". Setpoints will then revert back to their default value after internal timer "ToccTime" expires.</p> <p>To change setpoints permanently, revert this variable to No or write setpoints through the network. Any setpoints written through the network will be permanent and saved to EEPROM.</p> <p>Permnet: (permanent) Any change of occupied or unoccupied setpoints through the keypad by the user are permanent and saved to & EEPROM</p>																											
<p>SptFunc Local setpoint settings Default value = Dual Stp</p>	<p>Set the local setpoint interface for the user</p> <ul style="list-style-type: none"> ▪ Dual Stp (Dual Occupied Setpoints Adjustment) ▪ AttchStp (Single Occupied Setpoint Adjustment) 																											

<p>TOccTime Temporary occupancy time Default value = 2 hours</p>	<p>Temporary occupancy time with occupied mode setpoints when override function is enabled.</p> <p>When the Terminal Equipment Controller is in unoccupied mode, function is enabled with either the menu or UI2 configured as remote override input.</p> <p>Range is: 0,1, 2, 3, 4, 5, 6, 7, 8, 9, 10, & up to 24 hours</p>
<p>Deadband Minimum deadband Default value = 2.0 °F (1.0 °C)</p>	<p>The minimum deadband value between the heating and cooling setpoints. When modified, it will take effect only when any of the setpoints are modified again.</p> <p>Range is: 2, 3, 4 or 5 °F, 1.0 °F increments (1.0 to 2.5 °C, 0.5 °C increments)</p>
<p>Cal RS Room temperature sensor calibration Default value = 0.0 °F or °C</p>	<p>Offset that can be added/subtracted to the actual displayed room temperature</p> <p>Range is: ± 5.0 °F, 1.0 °F increments (± 2.5 °C, 0.5 °C increments)</p>
<p>Cal RH Humidity sensor calibration Default value = 0 %RH</p>	<p>Offset that can be added/subtracted to the actual displayed humidity by ± 15.0 %RH.</p> <p>Range is : ± 15.0 %RH</p>

<p>aux cont Auxiliary contact function & configuration Default value = 0 Not Used</p>	<p>0 Aux contact function used for reheat <u>IF SEQUENCE IS SET TO REHEAT THROUGH NETWORK OR LOCAL</u>, ignore this parameter.</p> <p>The output will directly follow the occupancy of the Terminal Equipment Controller 1 Auxiliary NO, Occ or St-By = Contact Closed / Unoccupied = Contact Opened 2 Auxiliary NC, Occ or St-By = Contact Opened / Unoccupied = Contact Closed</p> <p>Output to follow directly main occupancy and Fan on command Typically used for 2 position fresh air damper applications. 3 Auxiliary NO, Occ or St-By & Fan On = Contact Closed / Unoccupied & Fan On or Off = Contact Opened 4 Auxiliary NC, Occ or St-By & Fan On = Contact Opened / Unoccupied & Fan On or Off = Contact Closed</p> <p>Output to follow secondary network occupancy command 5 Auxiliary On-Off Control through auxiliary network command. The output can be commanded through the network for any required auxiliary functions through a separate & dedicated network variable.</p>
<p>Auto Fan Auto Fan Function Default value: AS</p>	<p>Auto Speed Fan Mode operation for Fan Sequences 2 and 3 AS = Auto Speed during occupied periods. Fan is always on during occupied periods.</p> <p>AS AD = Auto Speed / Auto Demand during occupied periods.</p>
<p>FL time For floating models SE73xxC5x45(x) only Default value: 1.5 minutes</p>	<p>Floating actuator timing Maximum stroke time of floating valve actuator.</p> <p>Range is: 0.5 to 9.0 minutes in 0.5 minutes increment</p>
<p>cph On-Off devices cycles per hour For On-Off models & sequences SE73xxC5x45(x) only Default value = 4 C.P.H.</p>	<p>Will set the maximum number cycles per hour under normal control operation. It represents the maximum number of cycles that the equipment will turn ON and OFF in one hour. Note that a higher C.P.H will represent a higher accuracy of control at the expense of wearing mechanical components faster.</p> <p>Range is: 3, 4, 5, 6, 7 & 8 C.P.H.</p>

<p>RA/DA For Analog models SE73xxF5x45(x) only Default value: DA signal</p>	<p>Reverse acting or Direct acting signal for Analog output signals DA = Direct acting, 0 to 100 % = 0 to 10 VDC RA = Reverse acting, 0 to 100 % = 10 to 0 VDC</p>
<p>Reheat Default value: 0 = 15 minute</p>	<p>Sets the reheat output time base Valid only if reheat sequences are enabled 0 = 15 minutes 1 = 10 seconds for Solid state relays</p>
<p>UI3 dis Display UI3 value.</p>	<p>Used as diagnostic or service help to troubleshoot and diagnose sensor operation Supply or change over temperature when UI3 is configured as an analog input (SS or COS)</p>

SPECIFICATIONS

Terminal Equipment Controller power requirements:	19-30 VAC 50 or 60 Hz; 2 VA Class 2
Operating conditions:	0 °C to 50 °C (32 °F to 122 °F) 0% to 95% R.H. non-condensing
Storage conditions:	-30 °C to 50 °C (-22 °F to 122 °F) 0% to 95% R.H. non-condensing
Temperature sensor:	Local 10 K NTC thermistor
Temperature sensor resolution:	± 0.1 °C (± 0.2 °F)
Temperature control accuracy:	± 0.5 °C (± 0.9 °F) @ 21 °C (70 °F) typical calibrated
Humidity sensor and calibration	Single point calibrated bulk polymer type sensor
Humidity sensor precision	Reading range from 10-90% R.H. non- condensing 10 to 20% precision is 10% 20 to 80% precision is 5% 80 to 90% precision is 10%
Humidity sensor stability	Less than 1.0% yearly (typical drift)
Dehumidification setpoint range	30 to 95% R.H.
Contact output rating	Triac output: 30 VAC, 1 Amp. Maximum, 3 Amp. In-rush. Analog: 0 to 10 VDC into 2KΩ resistance min.
Occ, Stand-By and Unocc cooling setpoint range:	12.0 to 37.5 °C (54 to 100 °F)
Occ, Stand-By and Unocc heating setpoint range:	4.5 °C to 32 °C (40 °F to 90 °F)
Room and outdoor air temperature display range:	-40 °C to 50 °C (-40 °F to 122 °F)
Proportional band for room temperature control:	Cooling & Heating: Default: 1.8°C (3.2°F)
Binary inputs:	Dry contact across terminal BI1, BI2 & UI3 to Scom
Wire gauge:	18 gauge maximum, 22 gauge
Approximate shipping weight:	0.75 lb (0.34 kg)
Agency Approvals all models:	UL: UL 873 (US) and CSA C22.2 No. 24 (Canada), File E27734 with CCN XAPX (US) and XAPX7 (Canada) Industry Canada: ICES-003 (Canada)
Agency Approvals all models:	FCC: Compliant to CFR 47, Part 15, Subpart B, Class A (US) CE : EMC Directive 89/336/EEC (Europe Union) C-Tick: AS/NZS CISPR 22 Compliant (Australia / New Zealand) Supplier Code Number N10696
Agency Approvals Wireless models:	FCC: Compliant to: Part 15, Subpart C

THIS DEVICE COMPLIES WITH PART 15 OF THE FCC RULES. OPERATION IS SUBJECT TO THE FOLLOWING TWO CONDITIONS: (1) THIS DEVICE MAY NOT CAUSE HARMFUL INTERFERENCE, AND (2) THIS DEVICE MUST ACCEPT ANY INTERFERENCE RECEIVED, INCLUDING INTERFERENCE THAT MAY CAUSE UNDESIRE OPERATION.



Please check with your local government for instruction on disposal of this product.

Schneider Electric 1354 Clifford Avenue, Loves Park, IL Tel: 1 888 444 1311 www.schneider-electric.com

DRAWING & DIMENSIONS

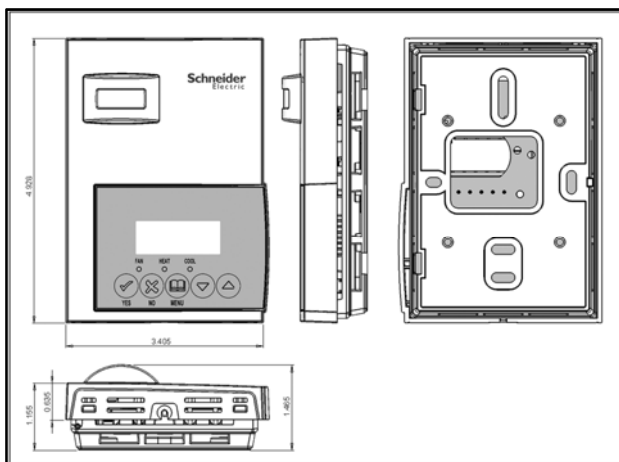

© 2011 Schneider Electric. All rights reserved.