

M6410A, M7410F Non-Spring Return Actuators FOR CARTRIDGE GLOBE VALVES

INSTALLATION INSTRUCTIONS

INSTALLATION

When Installing this Product...

1. Read these instructions carefully. Failure to follow them could damage the product or cause a hazardous condition.
2. Check ratings given in instructions and on the product to ensure the product is suitable for your application.
3. Installer must be a trained, experienced service technician.
4. After installation is complete, check out product operation as provided in these instructions.
5. Do not use Series 3000 actuators on 1/2 in. or 3/4 in. valves.

CAUTION

Equipment Damage Hazard.

Installing a high-force (67.5 lb [300 N] or 89.9 lb [400 N]) actuator on 1/2 or 3/4 in. valve can damage the valve beyond repair.

Use only Series 1000 (40.5 lb [180 N]) actuators with the smaller (1/2 in. and 3/4 in.) valves.

CAUTION

Electrical Shock or Equipment Damage Hazard. Can shock individuals or short equipment circuitry.

Disconnect power supply before installation.

IMPORTANT

A low-force (40.5 lb [180 N]) actuator installed on a valve larger than 3/4 in. cannot operate the valve.

Location

Select a location where the valve and actuator are accessible.

Mounting

No tools are required to install the actuators on valves because they are threaded onto the valve by hand.

CAUTION

Careless Installation Hazard.

Forcibly tightening the mounting connection can damage the valve and actuator.

Never tighten the connection with a wrench.

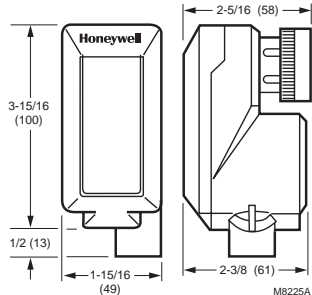

Fig. 1. Approximate dimensions in in. (mm).

Fig. 2 shows the M6410A, M7410F valve position indicator. To mount the actuator, refer to Fig. 3 through 4:

1. Remove valve protective cover (Fig. 3).
2. Make sure the actuator is in the (factory-supplied) OPEN position.
3. Screw the actuator connector onto the body of the valve (Fig. 4).

Wiring

Connect the actuator to the controller using the wiring diagram for the controller. See Fig. 5 for typical hookup to T6984F.

Use the M7410F with Excel[®] 5000/500/100/80 Controllers, T7984, and W7751 controllers. Power the M7410F from the same transformer as the controller when using Excel Systems, or T7984 Controllers, when the common lines from the controller and the actuator are connected together and the hot side of the 24 Vac power connection on the transformer is used. See Fig. 6. Electrical installation must comply with wiring diagram shown in Fig. 7.

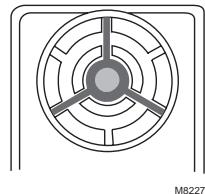

Fig. 2. Valve position indicator.



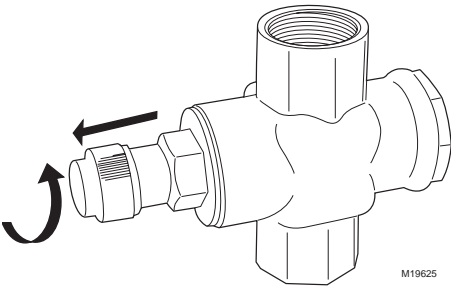

Fig. 3. Removing protective cover from valve.

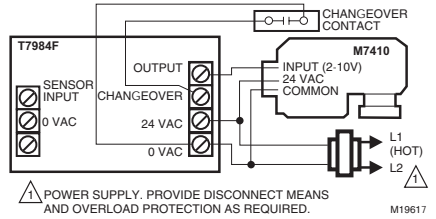

Fig. 6. M7410F used with T7984F.

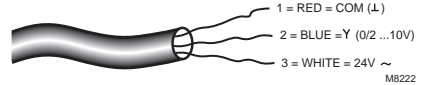

Fig. 7. Electrical installation showing wire colors and definitions.

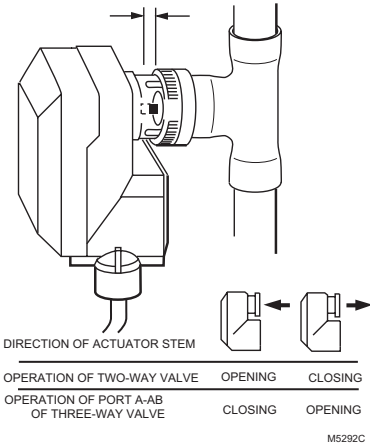

Fig. 4. Mounting actuator to valve.

NOTE: Two-way 1, 1-1/4, 1-1/2 in. valve operation is identical to three-way valve operation.

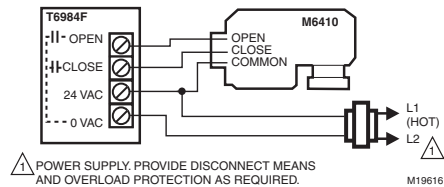

Fig. 5. M6410A used with T6984F.

Switch Selection (M7410F)

The two built-in selector switches must be set according to the valve type (two-way or three-way) and the controller output signal (0 to 10V or 2 to 10V). See Fig. 8.

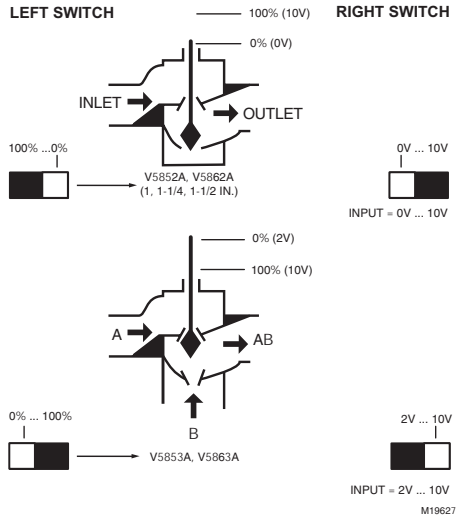

Fig. 8. Switch selection according to controller output signal and valve type (two-way or three-way) [1, 1-1/4, 1-1/2 in. valves shown].

Honeywell

Automation and Control Solutions

Honeywell International Inc.
1985 Douglas Drive North
Golden Valley, MN 55422

Honeywell Limited-Honeywell Limitée
35 Dynamic Drive
Scarborough, Ontario
M1V 4Z9

