

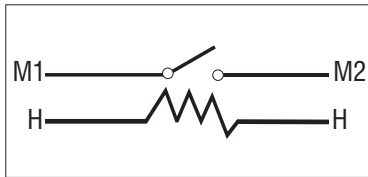

**Sealed Unit Parts Co., Inc.**  
 2230 Landmark Place • Allenwood, NJ 08720  
 (732)223-6644 • Fax (732)223-1617  
 www.supco.com • info@supco.com

# SUPCO "Q" Series Sequencer Wiring Diagram

## Q101 & Q109



Q101 OFF 40-110 Sec.  
 ON 1-20 Sec.  
 Q109 OFF 40-110 Sec.  
 ON 20-50 Sec.

## Q104 & Q110

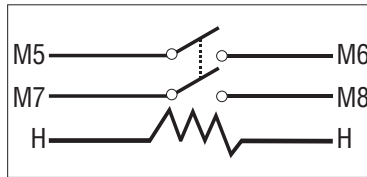

Q104 OFF 1-30 Sec.  
 ON 30-90 Sec.  
 Q 110 OFF 30-60 Sec.  
 ON 10-30 Sec.

## Q102

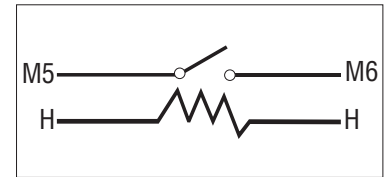

OFF 1-30 Sec.  
 ON 30-90 Sec.

## Q105

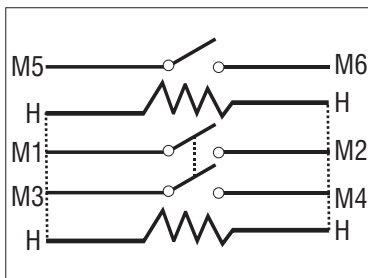

OFF 1-110 Sec.  
 ON 1-110 Sec.

## Q103 & Q113

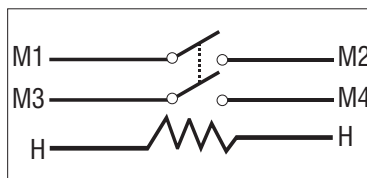

Q103 OFF 40-110 Sec.  
 ON 1-20 Sec.  
 \*Q113 OFF 15-65 Sec.  
 ON 30-10 Sec.  
 \*Q113 Has 240 Volt Heater

## Q106

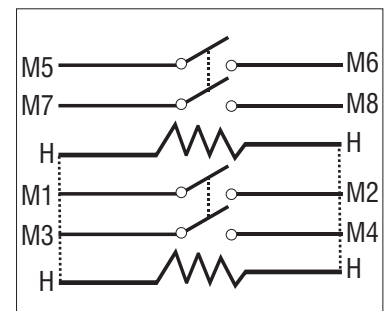

OFF 1-110 Sec.  
 ON 1-110 Sec.

## Q108

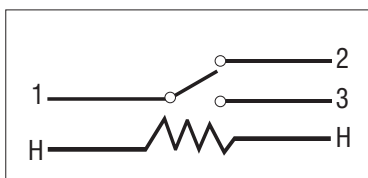

OFF 65-115 Sec.  
 ON 1-25 Sec.

## Q111

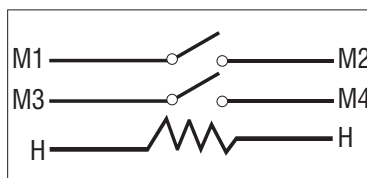

OFF M1-M2 90-160 Sec.  
 ON M1-M2 10-40 Sec.  
 OFF M3-M4 30-60 Sec.  
 ON M3-M4 10-30 Sec.

## Q107

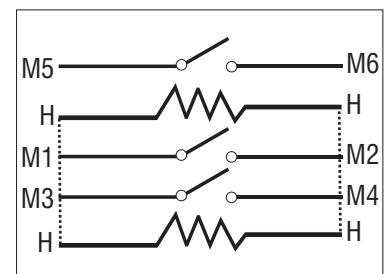

OFF 40-110 Sec.  
 ON 1-20 Sec.

## Q112

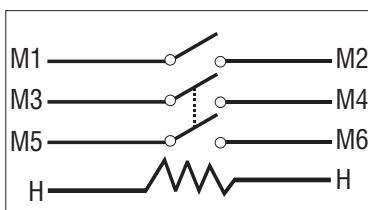

OFF M1-M2 90-150 Sec.  
 ON M1-M2 10-3 Sec.  
 OFF M3-M4 30-60 Sec.  
 ON M3-M4 10-30 Sec.  
 OFF M5-M6 30-60 Sec.  
 ON M5-M6 10-30 Sec.

## Q114

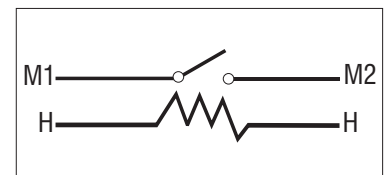

OFF 15-25 Sec.  
 ON 15-45 Sec.

**\*Note all sequencers include a 24 volt heater, except the Q113 which has a 240 volt heater.**



**Sealed Unit Parts Co., Inc.**  
 2230 Landmark Place • Allenwood, NJ 08720  
 (732)223-6644 • Fax (732)223-1617  
 www.supco.com • info@supco.com

## Q Series Competitive Cross Reference

SUPCO	MARS	WATSCO	KLIXON	TOD	W/R	HUGHES	WILMAR	JEPCO	OEM
Q101	33241	TDR10	6000AONI-98	15SH1309571	24A34-1	***	***	***	***
Q102	33242	TDR15	6000AONI-97	15SH1309572	24A34-2	102761	***	***	***
Q103	33244	TDR20	6000AONI-87	15SH2309573	24A34-3	102763	***	TD12	Janitrol BT1256504
Q104	33245	TDR25	6000AONI-86	15SH2309574	24A34-4	102765	***	TD34	***
Q105	33232	TDR30	51172-32	15SH21309575	24A34-5	102768	***	51172-32-2	***
Q106	33233	***	51172-22	15SH22309576	24A34-6	***	***	***	***
Q107	***	***	***	15SH41	***	***	***	***	***
Q108	***	***	***	12S50M	***	***	***	***	***
Q109	***	***	***	15SH1	***	102790	***	***	Goodman B13707-38
Q110	***	***	***	12S22	***	102788	***	***	Janitrol BT1256500
Q111	***	***	***	14S22	***	102786	***	***	Weatherking 422311608
Q112	***	***	***	14SX22	***	102787	***	***	Weatherking 422311606
Q113	33265	***	***	12S22	***	***	53-0834	***	
Q114									Coleman 7670-307, 308 3081, 3091,3101

\*Note all sequencers include a 24 volt heater, except the Q113 which has a 240 volt heater.