

T775L Series 2000 Electronic Stand-Alone Staging Controller

INSTALLATION INSTRUCTIONS

PRODUCT DESCRIPTION



The T775 electronic stand-alone controllers are the next generation of commercial and agricultural controls capable of remote sensing of temperature and providing switched and/or proportional outputs to various types of loads. A built-in time clock is standard.

The T775L model can be used to stage multiple relays from two independent heat or cool setpoints. The number of stages for each setpoint can be freely chosen, limited only by the number of relays available.

The T775L can be configured with up to two T775S Expansion Modules for a maximum of up to 12 stages.

IMPORTANT

The T775L is an operating control, not a limit or safety control. If used in applications requiring safety or limit controls, a separate safety or limit control device is required.

Table 1. T775L Controller Configuration.

Controller Model	Description	Output Reset	SPDT Relay Outputs	Digital Input	Sensor Inputs	Number of Sensors Included	Stage Control	Addable T775S	Enclosure
T775L2007 ^a	Stage Sequencer with Reset	Yes	4 ^b	1 ^c	2	1	Yes	Yes	NEMA 1

^a The T775L model can be used to stage multiple relays from two independent heat or cool setpoints. The number of stages for each setpoint can be freely chosen, limited by the number of relays available (up to 12 stages using two T775S expansion modules). In addition to the two staged loops, up to two additional relays can be available for independent on-off control.

^b The maximum number of non-sequenced relays is two (2) with each having its own setpoint and its own throttling range. These relays are available if not being used by the staged relay loops.

^c The T775L includes a digital input for use with the disable or setback option.



E4436



62-0257-05

Temperature Sensors^a

The controller accepts 1,097 Ohms PTC at 77°F (25°C):

- 50021579-001 – Standard sensor (included with all models except NEMA 4X models)
- T775-SENS-STRAP – Strap-on sensor with wiring box
- T775-SENS-WR – Water resistant with 5 foot leads (included with NEMA 4X models)
- T775-SENS-WT – Watertight with 6 foot lead
- T775-SENS-OAT – Outdoor air temperature sensor
- C7031B2008 – 6 inch duct mount with wiring box
- C7031D2003 – 5 inch immersion sensor with wiring box (use immersion well; P/N 50001774-001)
- C7031J2009 – 12 foot duct averaging sensor with wiring box
- C7046D1008 – 8 inch duct probe with mounting flange
- C7100D1001 – 12 inch fast response, duct averaging sensor with flange
- C7130B1009 – Room mount sensor

Accessories

- 107324A – Bulb Holder, duct insertion
- 107408 – Heat Conductive Compound, 4 ounce
- 50001774-001 – Immersion Well, stainless steel 304, 1/2 in. threading

^a See form 62-0265 – *Temperature Sensors for the T775 Series 2000 Stand-alone Controller*

Controller Dimensions

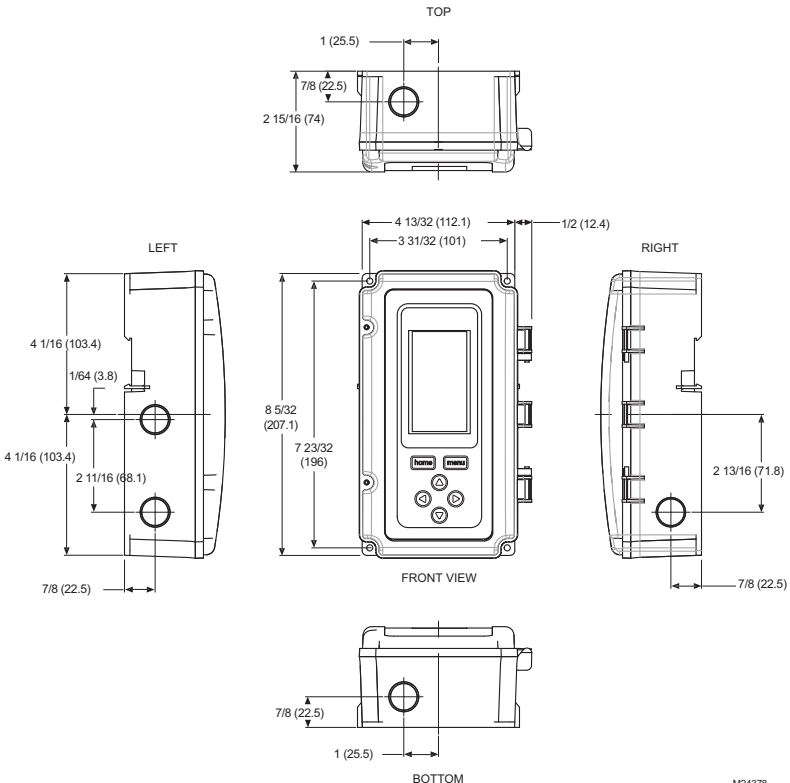

M24378

Fig. 1. T775L Dimensions in inches (mm).

BEFORE INSTALLATION

Review the “Specifications” on page 36 before installing the controller.

When Installing This Product

1. Read these instructions carefully. Failure to follow them could damage the product or cause a hazardous condition.
2. Check ratings given in instructions and on the product to ensure the product is suitable for your application.
3. Installer must be a trained, experienced service technician.
4. After installation is complete, check out product operation as provided in these instructions.

INSTALLATION AND SETUP

The following installation procedures are typically performed in the order listed:

1. Mounting – see “Mounting” below.
2. Wiring – see “Wiring” on this page.
3. Checkout – see page 8.
4. Interface and Programming overview – see page 9.
5. Setup – see page 11.
6. Programming the Controller with no Reset – see page 22 or Programming the Controller with Reset – page 24.
7. Scheduling (optional) – see page 31.

Additional topics are:

- Temperature sensor calibration begins on page 8.
- Interface overview begins on page 9.
- Summary menu begins on page 35.
- Troubleshooting begins on page 35.

MOUNTING

This section describes the mounting procedures for the controller and temperature sensor(s).

Controller Mounting

IMPORTANT

Avoid mounting in areas where acid fumes or other deteriorating vapors can attack the metal parts of the controller circuit board, or in areas where escaping gas or other explosive vapors are present.

IMPORTANT

The controller must be mounted in a position that allows clearance for wiring, servicing, and removal.

Use a screwdriver to pry out only the knockouts that you will use.

If mounting on DIN rail, be sure to remove the knockouts before mounting. See “Controller Wiring” on page 5 and Fig. 7 on page 6 for recommended knockout usage and locations. If you do not use an opened knockout be sure to cover it.

Mount the controller on any convenient interior location using the four mounting holes provided on the back of the enclosure using #6 or #8 screws (screws are not provided and must be obtained separately). Use controller dimensions in Fig. 1 on page 2 as a guide.

The controller may be mounted in any orientation. However, mounting in the orientation shown in Fig. 1 permits proper viewing of the LCD display and use of the keypad.

Temperature Sensor(s) Mounting and Location

Temperature sensors may be located up to 1,000 feet (304 m) from the T775L controller. See Table 3 on page 8 for calibration guidelines.

The sensors may be mounted on a wall or panel for sensing space temperature, strapped to a pipe or inserted in an immersion well (see Fig. 2) for hot or cold water sensing, or taped to a standard cap or bulb holder for duct air sensing. To prevent moisture or condensation entering the sensor through the lead wire holes, mount the sensor with the lead wires exiting the bottom of the sensor.

NOTES:

1. The included sensor is not designed for very wet applications. For immersion applications, an immersion well is used.
2. Heat conductive compound must be used in immersion wells.
3. See “Temperature Sensors” on page 2 for this type of installation.

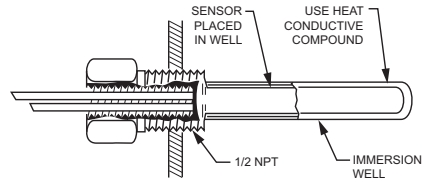

Fig. 2. Sensor inserted in immersion well.

NOTE: Multiple sensors may be parallel-series wired to sense average temperatures in large spaces. See Fig. 3 on page 4.

WIRING

All wiring must comply with applicable electrical codes and ordinances, or as specified on installation wiring diagrams. Controller wiring is terminated to the screw terminal blocks located inside the device.

The remainder of this section describes the temperature sensor wiring and the T775L controller wiring.

Wiring Connections Access

To access the wiring connections, remove the two screws on the left side of the enclosure and gently swing open the top. Be careful to not stress the ribbon cables that connect the keypad and LCD display to the controller circuit board.

Temperature Sensor Wiring

CAUTION

Electrical Shock Hazard.
Can short equipment circuitry.
 Make sure that metal tube of sensor does not short against T terminals in wall-mounted case.

IMPORTANT

Poor wiring practices can cause erratic readings from the sensor. Avoid the following to ensure proper operation:

- Do not route the temperature sensor wiring with building power wiring.
- Do not locate the temperature sensor wiring next to control contactors.
- Do not locate the temperature sensor wiring near electrical motors.
- Do not locate the temperature sensor wiring near welding equipment.
- Make sure good mechanical connections are made to both the sensor and the controller.
- Do not mount the sensor with the lead wire end pointing up in an area where condensation can occur.

If any of the above conditions cannot be avoided, use shielded cable.

NOTE: Each temperature sensor must be wired to a single T775 controller. However, a benefit of the T775 controller's accuracy is that there is no more than a 2°F differential between any two T775 controllers.

Reset Temperature Control

If you are implementing two-sensor reset control, Sensor A must always be the controlled temperature and Sensor B must always be the controlling temperature.

For example, in a reset control based on outside temperature, Sensor A must be the inside sensor and Sensor B must be the outside sensor.

Multiple Parallel Sensors

Multiple sensors can be parallel-series wired to sense average temperatures in large spaces. To maintain control accuracy, the number of sensors to be parallel-series wired must be of the n^2 power (for example, 4, 9, 16, etc.). See Fig. 3.

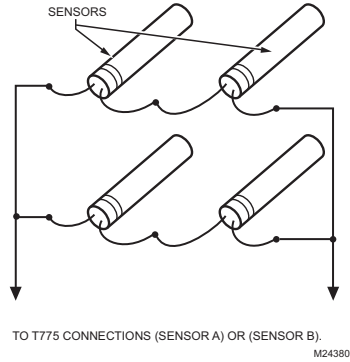

Fig. 3. Parallel-series wiring of sensors.

Temperature Sensor Wire Type and Size

Temperature sensors use standard AWG 18/2 unshielded wire. For cable runs greater than 25 feet or where electrical interference may be a problem, shielded cable is recommended. See Fig. 4.

Refer to "Temperature Sensor Calibration" on page 8 for wire size selection where cable runs are longer than 25 feet.

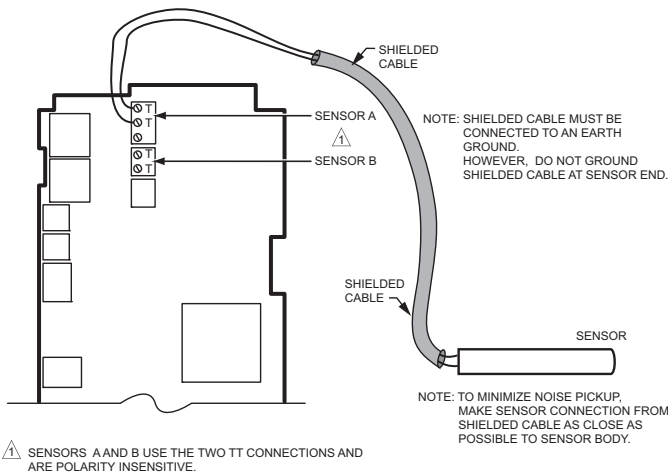

Fig. 4. Sensor Wiring — Showing shielded cable connection to Sensor A.

Controller Wiring

⚠️ WARNING

Electrical Shock Hazard.
Can cause severe injury, death or property damage.

Disconnect power supply before beginning wiring, or making wiring connections, to prevent electrical shock or equipment damage.

⚠️ CAUTION

Do not use 24 Vac power to power any external loads if 120 Vac or 240 Vac is used to power the T775L.

⚠️ CAUTION

A separate earth ground is required. Equipment damage can result if the earth ground is not connected. See Fig. 5 and Table 2 on page 6.

⚠️ CAUTION

Equipment Damage Hazard. Electrostatic discharge can short equipment circuitry. Ensure that you are properly grounded before handling the unit.

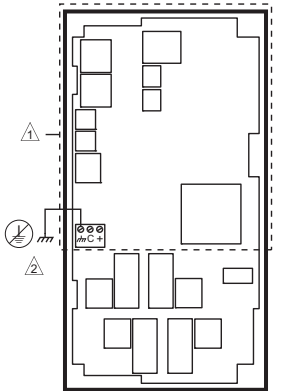

- ⚠️ NO HIGH VOLTAGE. CLASS 2 WIRING ONLY.
- ⚠️ EARTH GROUND TERMINAL MUST BE CONNECTED TO CONDUIT CLAMP LOCALLY.

M24296

Fig. 5. Earth Ground.

IMPORTANT

Poor wiring practices can cause erratic readings from the sensor. To ensure proper operation, ensure that good mechanical connections are made to both the sensor and the controller.

IMPORTANT

When wiring the input power, only one source of power can be applied to the T775L (24, 120, or 240 Vac).

See Fig. 7 on page 6 for locating the appropriate power input, remote sensors input, low voltage, contact closure, and load output terminals.

Access to the terminals can be gained through standard conduit knockouts (A through E in Fig. 7 on page 6) located around the perimeter of the enclosure:

- Knockouts A and B should be used only for sensor and low-voltage wiring.
- Knockouts C, D, and E can be used to gain access to the load relay output terminals and 120/240 Vac power wiring.

Controller Wiring Method

Wire the sensors and outputs, then wire the power connection.

Each terminal can accommodate the following gauges of wire:

- Single wire – from 14 AWG to 22 AWG solid or stranded
- Multiple wires – up to two 22 AWG stranded

For 24, 120, or 240 Vac power connections:

Single wire – from 14 to 18 AWG solid or stranded

Prepare wiring for the terminal blocks, as follows:

1. Strip 1/2 in. (13 mm) insulation from the conductor.
2. Cut a single wire to 3/16 in. (5 mm). Insert the wire in the required terminal location and tighten the screw.
3. If two or more wires are being inserted into one terminal location, twist the wires together a minimum of three turns before inserting them to ensure proper electrical contact.
4. Cut the twisted end of the wires to 3/16 in. (5 mm) before inserting them into the terminal and tightening the screw.
5. Pull on each wire in all terminals to check for good mechanical connection.

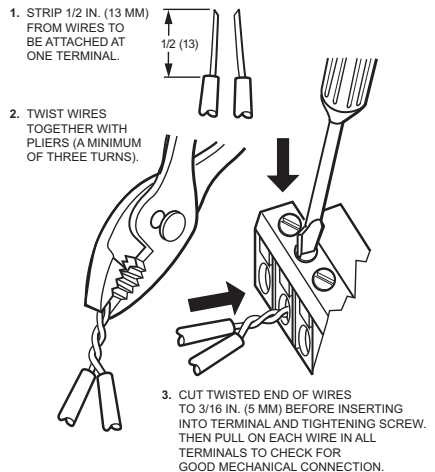

M24382

Fig. 6. Attaching two or more wires at terminal blocks.

Controller Wiring Details

The wiring connection terminals are shown in Fig. 7 and are described in Table 2 on page 6.

See Fig. 8 – Fig. 12 beginning on page 7 for typical T775L wiring applications.

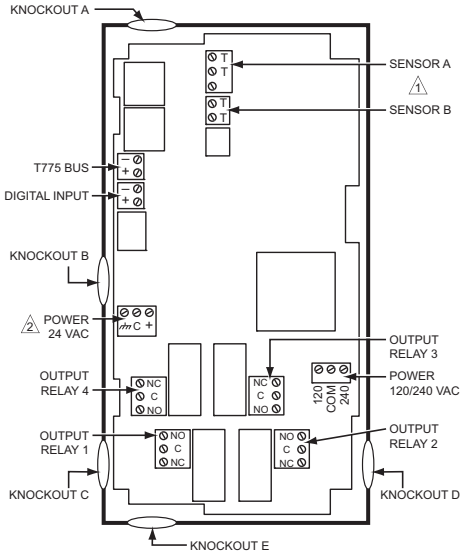

- ⚠ SENSORS A AND B USE THE TWO TT CONNECTIONS AND ARE POLARITY INSENSITIVE.
- ⚠ A SEPARATE EARTH GROUND IS REQUIRED FOR ANY POWER SOURCE (24, 120, OR 240 VAC).

M24383

Fig. 7. T775L Terminal and Feature Locations.

Table 2. Description of Wiring Terminal Connections.

Connection	Terminal Label	Description
Sensors		
Sensor A	T T	Temperature Sensor; polarity insensitive
Sensor B		
Outputs		
Relay 1	NO COM NC	120-240 Vac Relay Output
Relay 2		
Relay 3		
Relay 4		
Input		
DI	+ -	Digital Input (dry contact)
Interconnect		
T775 BUS	+ -	Terminal Connection to/from T775S
24 Vac Power		
24V +	+	24 Vac Hot
Common	-	24 Vac Common
Ground	⏏	Earth Ground ^a
120 or 240 Vac Power		
120 Vac	120	120 Vac Power
Common	COM	Common
240 Vac	240	240 Vac Power

^a A separate earth ground is required for all installations regardless of the power source (24, 120, or 240 Vac).

NOTE: Relays 5–8 are assigned to the first T775S Expansion Module, if connected. Relays 9–12 are assigned to the second T775S, if connected.

WIRING APPLICATION EXAMPLES

Fig. 8 – 12 beginning on page 6 illustrate typical controller wiring for various applications.

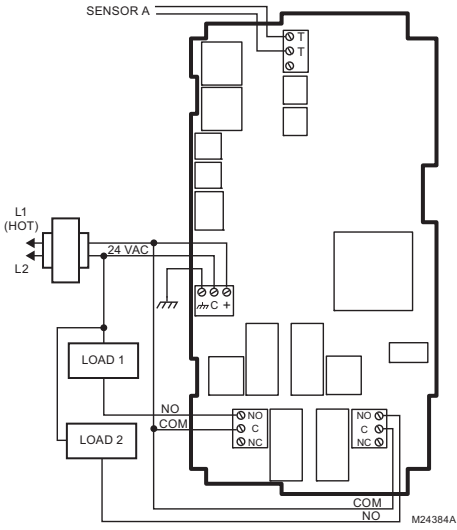

Fig. 8. Wiring for Two-stage Control – 24 Vac Input and 24 Vac Load.

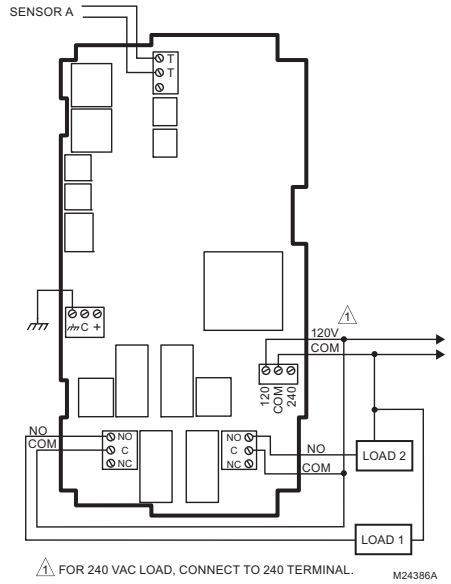

Fig. 10. Wiring for Two-stage Control with 120 or 240 Vac (120 Vac Input and 120 Vac Load shown).

⚠ FOR 240 VAC LOAD, CONNECT TO 240V TERMINAL.

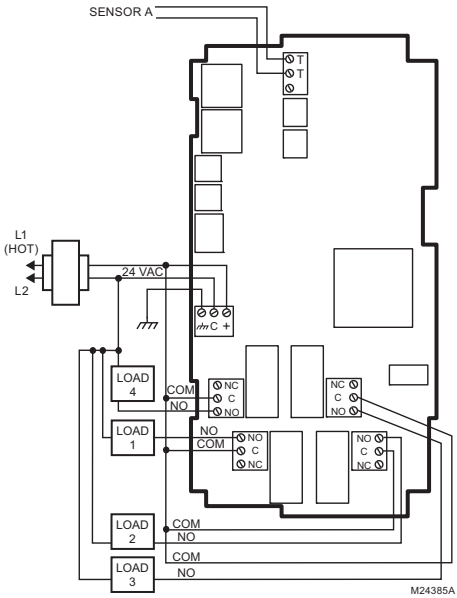

Fig. 9. Wiring for Four-stage Control – 24 Vac Input and 24 Vac Load.

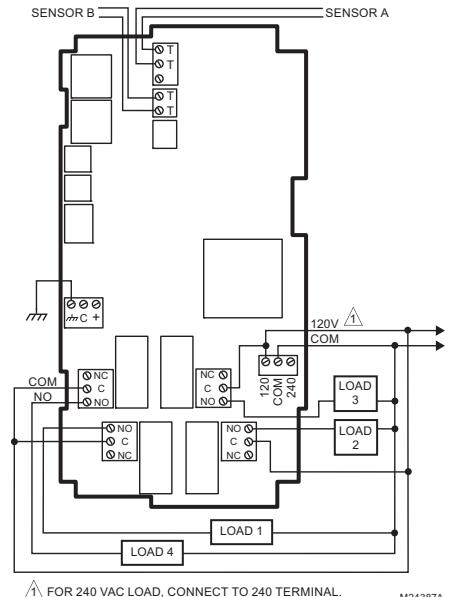

Fig. 11. Wiring for Four-stage Control with 120 or 240 Vac (120 Vac Input and 120 Vac Load shown).

⚠ FOR 240 VAC LOAD, CONNECT TO 240V TERMINAL.

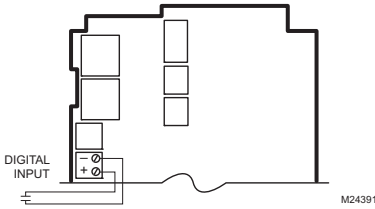

Fig. 12. Wiring for Digital Input (dry contact).

See "1.1.1.2. CALIBRATE (the sensor)" on page 13 for the instructions to enter the calibration value.

See Table 3 and Fig. 13 on page 8 for temperature resistance information.

Table 3. Temperature Sensor Calibration for Resistance Loss due to Wire Length.

AWG Rating	mΩ/ft	Temperature Offset in °F (Foot) ^a		
		200 ft	500 ft	1,000 ft
14	2.5	0.46	1.14	2.28
16	4.0	0.72	1.82	3.64
18	6.4	1.16	2.90	5.82
20	10.2	1.86	4.64	9.28
22	16.1	2.92	7.32	14.64

AWG Rating	mΩ/m	Temperature Offset in °C (Meter) ^a		
		100 m	200 m	300 m
14	8.3	0.44	0.86	1.30
16	13.2	0.68	1.38	2.06
18	21.0	1.10	2.18	3.28
20	33.5	1.74	3.48	5.22
22	52.8	2.74	5.48	8.22

^a This is the distance from the controller to the sensor (already accounts for round trip distance).

Fig. 13 shows how sensor resistance varies with temperature for a sensor having a positive temperature coefficient (PTC) of 2.1 Ohms per degree F (3.85 Ohms per degree C).

CHECKOUT

Inspect all wiring connections at the controller terminals, and verify compliance with the installation wiring diagrams.

⚠ WARNING

Electrical Shock Hazard.
Can cause severe injury, death or property damage.

Disconnect power supply before beginning wiring or making wiring connections, to prevent electrical shock or equipment damage.

If any wiring changes are required, *first* be sure to remove power from the controller *before* starting work. Pay particular attention to verifying the power connection (24, 120, or 240 Vac).

After the controller is mounted and wired, apply power.

Power Loss

The date and time settings are retained for 24 hours after a power outage. After a power loss of more than 24 hours, the date and time settings may need to be reentered. All other settings are stored permanently.

Temperature Sensor Calibration

As wire length increases, resistance increases and thus the temperature reading increases. If necessary, calibrate the sensor input by reducing the value by the amount shown in the Table 3. For example, a wire run with 18 gauge wire of 1,000 feet, requires a calibration offset of -6.0 °F.

IMPORTANT

If the calibration value in the table exceeds the controller's calibration limits of +/-10°F (+/-6°C), you must use a heavier gauge wire.

For example, with a wire run of 1,000 feet you must use 20 AWG wire or heavier in order to calibrate for wire loss within the limits of the controller.

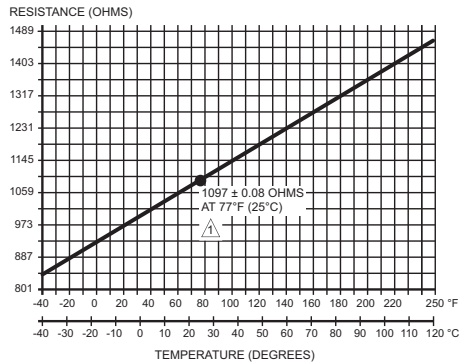

△ POSITIVE TEMPERATURE COEFFICIENT (PTC) OF 2.1 OHMS PER °F M24304

Fig. 13. Sensor Resistance vs. Temperature.

INTERFACE OVERVIEW

The T775L controller uses an LCD panel and 6-button keypad to provide status information and permit user input of the programming, setup, and scheduling parameters.

The following figure describes the display areas of the LCD and the keypad.

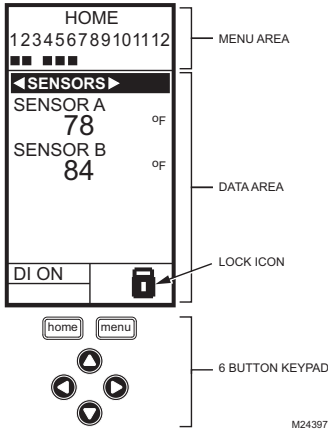

Fig. 14. LCD Display - Home Screen And Keypad.

Menu Area – On the home screen, the LCD displays the configured relays and whether they are active. In Program, Setup, or Schedule mode, the LCD displays the current menu selection and its order within the menu hierarchy.

Data Area – On the home screen, the LCD displays the sensors and outputs status. In Setup or Program mode, the LCD displays menu choices, parameter selections, and data values.

Lock Icon – The icon indicates the **MENU** button is locked and prevents access to the Setup and Program menus.

NOTE: Pressing and holding the **HOME** and **MENU** buttons simultaneously for five seconds locks/unlocks the **MENU** button.

6-Button Keypad – The keypad is used to access the menus and enter values (see “Using the LCD Panel Interface”).

Using the LCD Panel Interface

The 6-button keypad is used to move through the menus and enter or change parameter values.

Home Button

Pressing the **HOME** button at any time exits the current Programming or Setup display screen and returns to the home screen as shown in Fig. 14 and Fig. 15.

Menu Button

- Pressing the **MENU** button always displays the Program menu. If you are in Setup mode, you exit setup and return to the Program menu.

- Pressing and holding the **MENU** button for five seconds leaves the current screen and displays the Setup menu.

Left and Right Arrow Buttons (◀ and ▶)

Use these buttons to move backward (◀) and forward (▶) through the Program and Setup menus.

Up and Down Arrow Buttons (▲ and ▼)

Use these buttons to move your selection up and down through a menu or list.

- When the desired item is highlighted, you press the ▶ arrow button to display that item’s content.
- When a value is displayed (e.g. 70°F), the up and down arrows increase and decrease the value.

NOTE: Once you select an item from a list or enter a value, pressing the ◀ or ▶ or **HOME** button accepts your selection or value and stores it in the controller’s memory.

Home Screen

In the normal run state, the LCD home screen displays the current sensed temperatures, the active status of the output loops and relays, and error and status codes.

When using Reset, the Heat/Cool setpoint(s) display on the home screen for the Loop and Relay outputs; see Fig. 15.

Active relays are indicated by the small black square (■) just below the relay number. Fig. 15 shows the home screen with relays 1, 2, and 4–6 energized.

Pressing the ◀ and ▶ buttons from the home screen cycles through the sensors, loops, and additional relay(s).

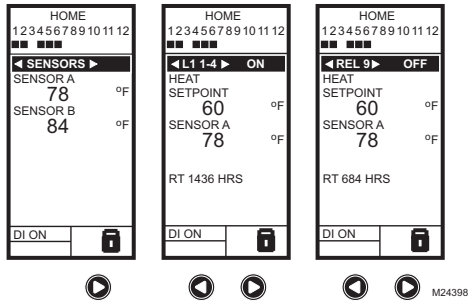

Fig. 15. LCD Display - Home Screen Displaying Sensors, Loops, and additional Relay(s).

NOTES:

- The loop home screen and the relay home screen do not dynamically update the active relay status and sensor values. The information is a snapshot taken when you press the ◀ or ▶ button to display the screen.
- In Reset mode, the home screen displays the effective setpoint.

IMPORTANT

After four minutes of inactivity (no buttons pressed), the LCD display reverts to the home screen display.

Accessing the Menus

Menus are used for setup, programming, scheduling, and viewing the summary settings.

Program, Schedule, and Summary Menus

To access these menus from the home screen, press the **MENU** button. See Fig. 16.

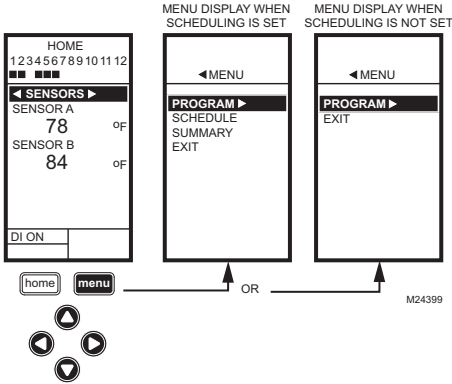

Fig. 16. Menus.

Depending on whether scheduling is enabled or not, the LCD displays one of two menus as shown in Fig. 16. Scheduling is enabled from the Setup menu's Output settings (see "1.3.3.1. USE SCHED" on page 15).

Setup Menu

To access the Setup menu, press and hold the **MENU** button for five seconds. See Fig. 17.

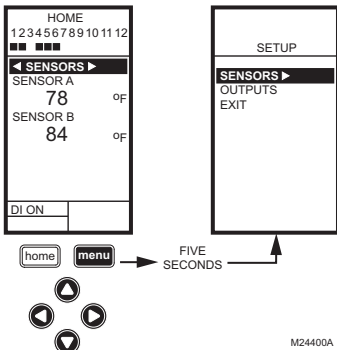

Fig. 17. Setup Menu.

Using the Menus

When you are working with the menus, use the:

- **Left arrow button (◀)** to scroll backward through the menus
- **Right arrow button (▶)** to select the highlighted menu item and display its content
- **Up and Down arrow buttons (▲ and ▼)** to scroll up and down through a list of items or to increase or decrease the value of a displayed parameter

NOTES:

1. If you press the **HOME** button or there is no keypad activity for four minutes, you exit Program mode and return to the home screen.
2. If you press the **MENU** button, you exit and return to the menu.

PROGRAMMING OVERVIEW

The controller must be programmed before being placed into service.

IMPORTANT

During programming, the controller is live at all times. For example, the contacts may open and close when adjusting the setpoint.

The programming process uses a hierarchical menu structure that is easy to use. You press the ◀ and ▶ arrow buttons to move forward and backward through the menus.

NOTES:

1. The T775L controller interface is intuitive. You may want to use this procedure simply as a reference to locate the particular option or parameter of interest.
2. The menu can display only those relays that are defined in Setup (see "1.3.1. Number of RELAYS" on page 14). For example, if you configure only one relay, then only one relay displays on the appropriate menu.
3. If you press the **HOME** button or there is no keypad activity for four minutes, you exit Program mode and return to the home screen.
4. If you press the **MENU** button, you exit Program mode and return to the menu.

Control Loops

The T775L provides the capability to have up to two PID control loops, which allow multiple stages to be assigned to a single setpoint in each loop.

Setpoint and Differential

The following describes the relationship between setpoint and differential for heating and cooling. These settings are programmed for each output relay.

Heating Mode Setpoint and Differential

In heating mode, the differential is below the setpoint. The relay de-energizes when the temperature rises to the setpoint. As the temperature drops to the setpoint minus the differential, the relay energizes.

Cooling Mode Setpoint and Differential

In cooling mode, the differential is above the setpoint. The relay de-energizes when the temperature falls to the setpoint. As the temperature rises to the setpoint plus the differential, the relay energizes.

Setpoint High Limit

You can set an irreversible setpoint high limit maximum value for any single displayed setpoint value.

Adjust the setpoint (at any output) to the desired maximum setpoint. Then, simultaneously press the **HOME**, **◀**, and **▶** buttons and continue to press all three buttons for five seconds to set the setpoint high limit maximum to this value.

NOTE: You must press all three buttons at exactly the same time for this action to occur.

IMPORTANT

1. This action sets the maximum setpoint value of all outputs to the setpoint high limit maximum.
2. Setting the high limit setpoint maximum is **irreversible**. If you perform the action inadvertently and this setpoint adversely affects the control of your system, you must replace the controller.

Staged Operation

Staging occurs as illustrated in Fig. 18 for a Heat setpoint of 200°F and a throttling range of 20°F when the Integral value is zero (0). When the Integral is not zero, then the actual temperatures at which stages energize and de-energize will vary from this example; see "1.3.4.2. INTEGRAL" on page 18.

NOTE: A non-zero integral causes the control to move toward the setpoint value.

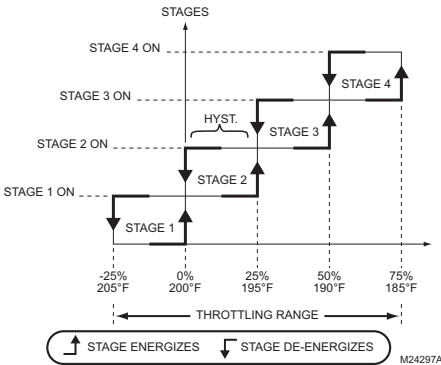

Fig. 18. Staging Behavior
(when effective Setpoint = 200°F).

Programming the T775L Controller

In addition to the two staged loops, up to two additional relays can be available for independent on-off control. Examples of Loop and Relay configurations are:

- Number of relays = 8. Loop 1 uses relays 1-3, and Loop 2 uses relays 4-6. The remaining two relays (7 and 8) are available for use.
- Number of relays = 11. Loop 1 uses relays 1-5, and Loop 2 uses relays 6-10. The remaining relay (11) is available for use.
- Number of relays = 12. Loop 1 uses relays 1-4, and Loop 2 uses relays 5-8. Relays 9 and 10 are available for use, but in this case, relays 11 and 12 are not usable.
- Number of relays = 8. Loop 1 uses relays 1-6, and Loop 2 uses relays 7-8. There are no additional relays available for use.

IMPORTANT

If you change the number of relays, the controller resets the number of relays per loop to zero (0) for all loops. You must use Setup mode to reconfigure all loops and additional relays. See page 11.

To program the controller, perform the setup configuration (see "1. Setup") and then select one of the following procedures depending on whether the Reset function is to be used:

- Program the Outputs for No Reset — see "2. Programming Output (Loops and Additional Relays) with No Reset" on page 22.
- Program the Outputs for Reset — see "" on page 24.

When programming is complete, you may continue with "4. Scheduling" on page 31.

1. SETUP

Setup provides the ability to change the factory default settings for the temperature sensors and outputs, to enable/disable reset control, and to enable/disable scheduling.

IMPORTANT

If you change the number of relays, the controller resets the number of relays per loop to zero (0) for all loops. You must use Setup mode to reconfigure all loops and additional relays.

NOTE: The T775L controller interface is intuitive. You may want to use this procedure simply as a reference to locate the particular option or parameter of interest.

NOTES:

1. If you press the **HOME** button or there is no keypad activity for four minutes, you exit Setup mode and return to the home screen.
2. If you press the **MENU** button, you exit Setup mode and go to the Program menu.

Once in Setup mode, you use the —

- **Left arrow button (◀)** to scroll backward through the Setup menus
- **Right arrow button (▶)** to select the highlighted menu item and display its content
- **Up and Down arrow buttons (▲ and ▼)** to scroll up and down through a list of items or to increase or decrease the value of a displayed setup parameter

Setup Procedure

The Setup process uses a hierarchical menu structure that is easy to use. You press the **◀** and **▶** arrow buttons to move forward and backward through the menus.

NOTE: The menus can display only those relays that are defined in Setup (see "1.3.1. Number of RELAYS" on page 14). For example, if you configure only two relays, then only two relays display on the appropriate menus.

To change the controller's sensors and output setup parameters, perform the following procedures in the order listed:

1. Enter Setup mode — see "Entering Setup Mode".
2. Setup Sensors — see "1. Setting up the Sensors".
3. Setup Outputs — see "1.3. Setting up the Outputs" on page 14.
4. Exit Setup Mode — see "1.4. Exiting Setup" on page 21.

Entering Setup Mode

To enter Setup mode, press and hold the **MENU** button for five seconds to display the Setup menu. See Fig. 17 on page 10.

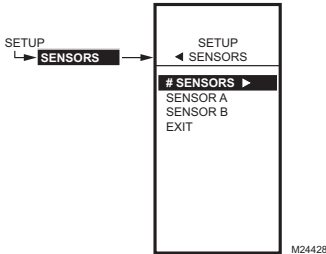

Fig. 19. Setup - Sensors Menu.

1. Setting up the Sensors

1. From the Setup menu, use the ▲ and ▼ buttons to highlight **SENSORS**.
2. Press the ► button to display the Sensors menu.

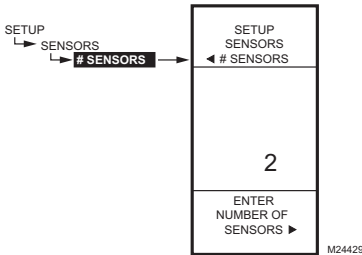

Fig. 20. Setup - Sensors - Number of Sensors.

1.1. Number of SENSORS

The value entered here determines the number of sensors displayed on the home screen.

1. From the Sensors menu, highlight # SENSORS then press the ► button to display the number of sensors.
2. Use the ▲ and ▼ buttons to enter the number of sensors (1 or 2).
Default: 2
3. Press the ► button to accept the value and display the SENSOR A selection.

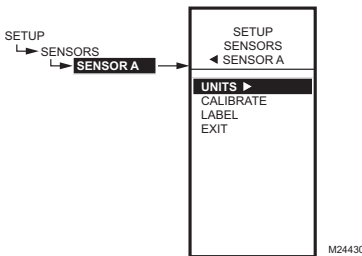

Fig. 21. Setup - Sensors - Sensor A Menu.

1.1.1. SENSOR A

If you are implementing two-sensor reset control, Sensor A must always be the controlled temperature and Sensor B must always be the controlling temperature. For example, in a reset control based on outside temperature, Sensor A must be the inside sensor and Sensor B must be the outside sensor.

1. From the Sensors menu, highlight **SENSOR A**.
2. Press the ► button to display the Sensor A selections.

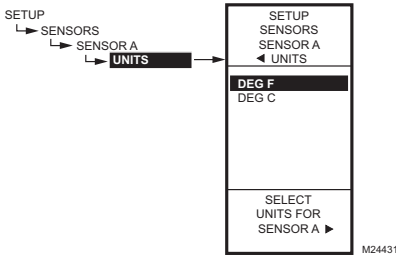

Fig. 22. Setup - Sensors - Sensor A - Units.

1.1.1.1. UNITS (°F or °C)

IMPORTANT

*This is a global change and affects the unit values for all temperature parameters on all displays.
This UNITS screen displays only for Sensor A.*

1. From the Sensor A selections, use the ▲ and ▼ buttons to highlight UNITS.
2. Press the ► button to display the temperature units.
3. Use the ▲ and ▼ buttons to highlight DEG F or DEG C.
Default: F (Fahrenheit)
4. Press the ► button to accept the units and return to the Sensor A selections.

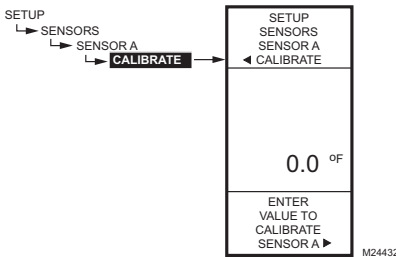

Fig. 23. Setup - Sensors - Sensor A - Calibrate.

1.1.1.2. CALIBRATE (the sensor)

Ensure that the wire size calibration value is within the limits. See "Temperature Sensor Calibration" on page 8.

1. From the Sensor A selections, use the ▲ and ▼ buttons to highlight CALIBRATE.
2. Press the ► button to display the calibration degree value.
3. Use the ▲ and ▼ buttons to increase/decrease the desired calibration degrees.
Default: 0
Range: +/-10°F (+/-6°C)
4. Press the ► button to accept the value and return to the Sensor A selections.

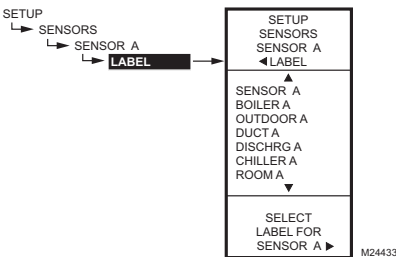

Fig. 24. Setup - Sensors - Sensor A - Label.

1.1.1.3. LABEL (the sensor input)

For a sensor already labeled, the display positions to and highlights that label.

1. From the Sensor A selections, use the ▲ and ▼ buttons to highlight LABEL.
2. Press the ► button to display the label list.
3. Use the ▲ and ▼ buttons to scroll through list and highlight the desired label.
You may need to scroll up or down to view all possible labels.
4. Use the ► button to accept the highlighted label and exit the list.

NOTE: The label names in list order are: Sensor, Boiler, Outdoor, Duct, Dischrg, Chiller, Room, Supply, Return, and Animals.

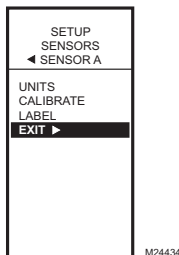

Fig. 25. Setup - Sensors - Sensor A - Exit.

1.1.1.4. Exit Sensor A Setup

Press the ◀ button to exit Sensor A selections and return to the Sensors menu.

- or -

Use the ▲ and ▼ buttons to highlight EXIT and press the ► button.

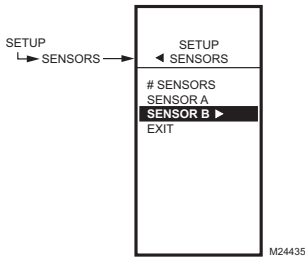

Fig. 26. Setup - Sensors - Sensor B Menu.

1.2.1. SENSOR B

For two-sensor reset control, Sensor B must always be the controlling temperature. For example, in a reset control based on outside temperature, Sensor B must be the outside sensor.

1. From the Sensors menu, use the ▼ button to highlight SENSOR B.
2. Press the ► button to display the Sensor B menu.
3. Repeat the selections described in "1.1.1. SENSOR A" through "1.1.1.4. Exit Sensor A Setup" beginning on page 12.

Continue with "1.3. Setting up the Outputs".

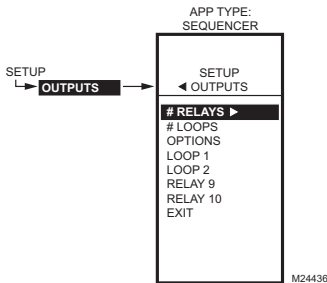

Fig. 27. Setup - Outputs Menu.

1.3. Setting up the Outputs

1. From the Setup menu, use the ▲ and ▼ buttons to highlight OUTPUTS.
2. Press the ► button to display the Outputs menu.
3. Continue with "1.3.1. Number of RELAYS".

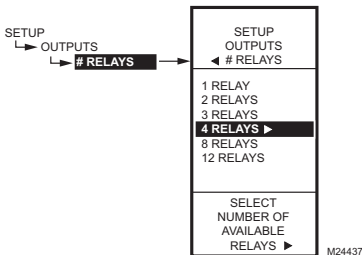

Fig. 28. Setup - Outputs - Number of Relays.

1.3.1. Number of RELAYS

1. From the Outputs menu, use the ▲ and ▼ buttons to highlight # RELAYS.
2. Press the ► button to display the number of relays.
3. Use the ▲ and ▼ buttons to select the number of relays depending on setup. (See note below.)
4. Press the ► button to accept the value and display the Outputs menu.

IMPORTANT

If you change the number of relays, the controller resets the number of relays per loop to zero (0) for all loops. You must use Setup mode to reconfigure all loops and additional relays.

NOTE: Up to two T775S Expansion Modules can be connected to a T775L, making the following outputs available:
 T775L: 4 relay outputs
 T775L with one T775S module: 8 relay outputs
 T775L with two T775S modules: 12 relay outputs

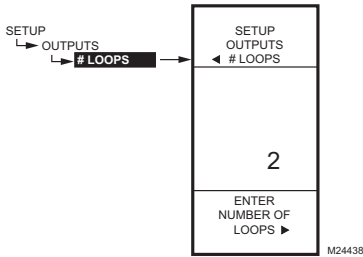

Fig. 29. Setup - Sensors - Number of Sensors.

1.3.2. Number of LOOPS

The value entered here determines the number of loops displayed on the home screen.

1. From the Outputs menu, highlight # LOOPS then press the ► button to display the number of loops.
2. Use the ▲ and ▼ buttons to enter the number of loops (1 or 2).
Default: 1
3. Press the ► button to accept the value and display the Outputs menu.

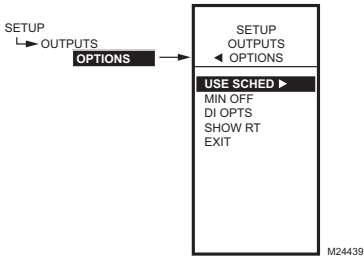

Fig. 30. Setup - Outputs - Options Menu.

1.3.3. OPTIONS

1. From the Outputs menu, use the ▲ and ▼ buttons to highlight OPTIONS.
2. Press the ► button to display the Options menu.

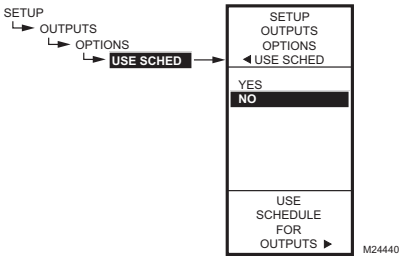

Fig. 31. Setup - Outputs - Options - Schedule.

1.3.3.1. USE SCHED

1. Press the ► button to display the schedule selections.
2. Use the ▲ and ▼ buttons to highlight YES or NO.
Default: NO
3. Press the ► button to accept the value and display the MIN OFF option.

Selecting NO disables scheduling for **all** outputs.

Selecting YES enables scheduling for the setpoint. However, each individual output can be removed from scheduling as desired.

With Scheduling enabled, when you return to Program mode, the new option for Scheduling displays. You can press the **HOME** button and then the **MENU** button to view the Schedule options in the menu.

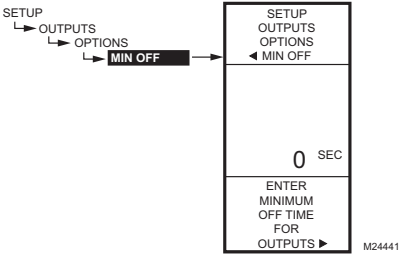

Fig. 32. Setup - Outputs - Options - Min Off Time.

1.3.3.2. MIN OFF (minimum off time for all relays)

This is the minimum number of seconds of “off time” for all relays that are not configured in a loop.

1. Press the ▶ button to display the Min Off value.
2. Use the ▲ and ▼ buttons to increase/decrease the desired number of seconds from 0 to 990 seconds in 10 second increments.
Default: 0 (zero)
Range: 0 to 990 seconds
3. Press the ▶ button to accept the seconds and display the DI OPTS menu.

NOTES:

1. The minimum off time applies to all relay outputs.
2. When minimum off time is active, relays waiting to be energized display a flashing square underneath the relay number on the home screen.
3. If the minimum off time is not equal to zero (0), the minimum off time activates at power-up.
4. To manually override, press the ◀ button.

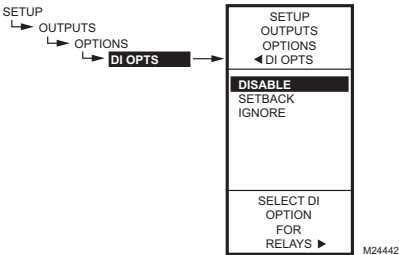

Fig. 33. Setup - Outputs - Options - DI Options.

1.3.3.3. DI OPTIONS (digital input options)

The DI Option that you select applies to all outputs. This option overrides any Setpoint/Setback values entered in the Schedule.

1. Press the ▶ button to display the DI Option selections.
2. Use the ▲ and ▼ buttons to highlight DISABLE, SETBACK, or IGNORE.
Default: DISABLE
3. Press the ▶ button to accept the value and display the SHOW RT menu.

When the digital input (DI) closes, all outputs follow the DI option value (Disable, Setback, or Ignore):

- **DISABLE** disables the outputs; relays return to de-energized state.
- **SETBACK** enables a setback temperature value to be programmed for each output.
 - To program the Setback temperature without Reset, see Fig. 57 on page 24.
 - To program the Setback temperature with Reset, see Fig. 68 on page 28.
- **IGNORE** causes the digital input to have no effect on the Relay outputs.

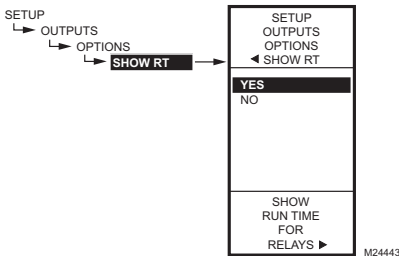

Fig. 34. Setup - Outputs - Options - Show Runtime.

1.3.3.4. SHOW RT (show run time hours)

1. Press the ▶ button to display the Show RT values.
2. Use the ▲ and ▼ buttons to select YES or NO.
Default: YES
3. Press the ▶ button to accept the value and return to the Options menu.

A limited feature in the T775L, selecting YES shows the run time hours only of independent relays if they are among the first four relays. Runtime of relays in a loop cannot be shown.

NOTE: Run times can be reset to zero for each of the first four independent relays. You must do this for each relay that you want to reset to zero. See “1.3.5.3. RESET RT (Run Time)” on page 21.

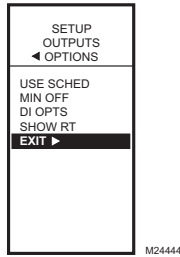

Fig. 35. Setup - Outputs - Options - Exit.

1.3.3.5. Exit Options Setup

Press the ◀ button (or highlight EXIT and press the ▶ button) to exit and return to the Outputs menu.

Continue with "1.3.4. Setting up the Loops"

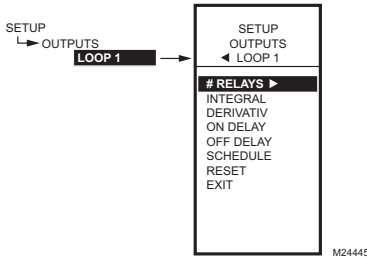

Fig. 36. Setup - Outputs - Loop 1 Menu.

1.3.4. Setting up the Loops

1. From the Outputs menu, use the ▲ and ▼ buttons to highlight the desired loop (1 or 2 depending on configuration).
2. Press the ▶ button to display the selected loop menu.

Continue with the remainder of this section to setup the loops.

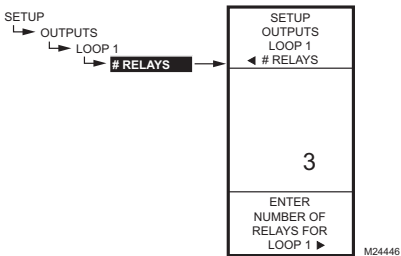

Fig. 37. Setup - Outputs - Loop 1 - Number of Relays.

1.3.4.1. Number of RELAYS

1. From the Loop 1 menu, use the ▲ and ▼ buttons to highlight # RELAYS.
2. Press the ▶ button to display the number of relays.
3. Use the ▲ and ▼ buttons to select the number of relays depending on setup. (See "1.3.1. Number of RELAYS" on page 14.)
4. Press the ▶ button to accept the value and display the Loop 1 menu.

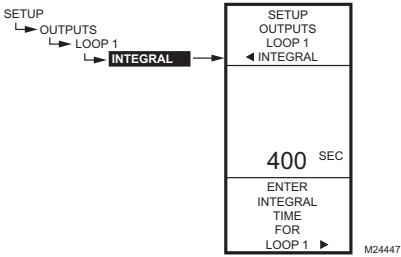

Fig. 38. Setup - Outputs - Loop 1 - Integral.

NOTES:

1. The Integral time is factory set for 400 seconds. This is a good middle range and should satisfy many applications. The integral time can be increased for applications where sensed response is slow, and can be decreased for applications where sensed response is fast (e.g. discharge air control).
2. As a starting point, an optimal integral time for discharge air typically ranges from 12 to 200 seconds. An optimal integral time for room control typically ranges from 60 to 2,500 seconds. The purpose of integral action is to reduce or eliminate

the offset from setpoint during steady state control that is often seen in proportional only control.

3. Keep in mind that control is most sensitive to throttling range. Adjust the throttling range first before any adjustment to integral time. Adjust throttling range to be as wide as possible to start since this will provide the most stable control. Remember that the integral will eliminate the steady state error so you do not need to have a small throttling range to have accurate control. (Integral action allows for controlling to a setpoint even with a wide throttling range).

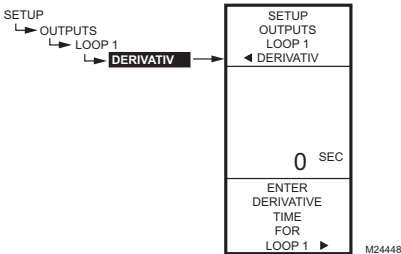

Fig. 39. Setup - Outputs - Loop 1 - Derivative.

1.3.4.3. DERIVATIVE

The Derivative default value is factory set to zero (no derivative control). It is strongly recommended that the derivative remain at zero (0) unless you have a very good reason to adjust it. Derivative control is not needed in the vast majority of HVAC applications.

1. From the Loop 1 menu, use the ▲ and ▼ buttons to highlight DERIVATIVE, then press the ► button to display the derivative seconds.
2. Use the ▲ and ▼ buttons to increase/decrease the value.
Default: 0 (zero)
Range: 0 to 3,600 seconds
3. Press the ► button to accept the value and display the Loop 1 menu.

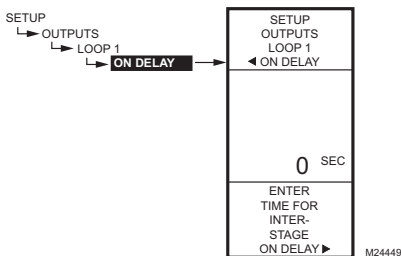

Fig. 40. Setup - Outputs - Loop 1 - On Delay.

1.3.4.4. ON DELAY

This is the minimum time delay between consecutive ON stages.

1. From the Loop 1 menu, use the ▲ and ▼ buttons to highlight ON DELAY, then press the ► button to display the interstage on delay.
2. Use the ▲ and ▼ buttons to change the on delay time.
Default: 0 (zero) seconds
Range: 0 to 3,600 seconds in 10 second increments
There is a built-in minimum delay of 1 second between stages upon energizing.
3. Press the ► button to accept the value and display the Loop 1 menu.

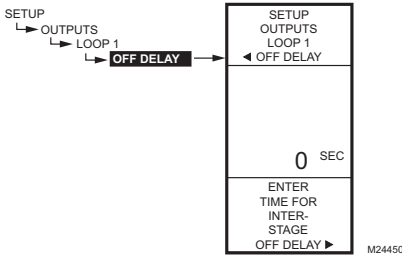

Fig. 41. Setup - Outputs - Loop 1 - Off Delay.

1.3.4.5. OFF DELAY

This is the minimum time delay between consecutive OFF stages.

- From the Loop 1 menu, use the ▲ and ▼ buttons to highlight OFF DELAY, then press the ► button to display the interstage off delay.
- Use the ▲ and ▼ buttons to change the off delay time.
 - Default: 0 (zero) seconds
 - Range: 0 to 3,600 seconds in 10 second increments
 - There is a built-in minimum delay of 1 second between stages upon energizing.
- Press the ► button to accept the value and display the Loop 1 menu.

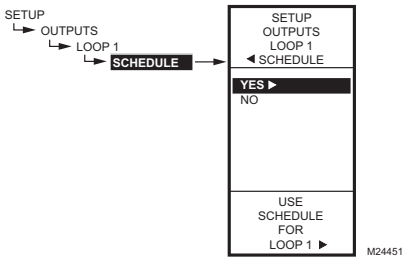

Fig. 42. Setup - Outputs - Loop 1 - Schedule.

1.3.4.6. SCHEDULE

The Schedule option displays only if the USE SCHED parameter is set to Yes (see Fig. 31 on page 15).

- From the Loop 1 menu, use the ▲ and ▼ buttons to highlight SCHEDULE.
- Press the ► button to display the value.
- Use the ▲ and ▼ buttons to select YES or NO.
 - Default: YES
- Press the ► button to accept the value and display the Loop 1 menu.

An individual output can be selected to be controlled or not controlled by the schedule. If NO is selected, the Setback selection does not appear in the Program menu for this output.

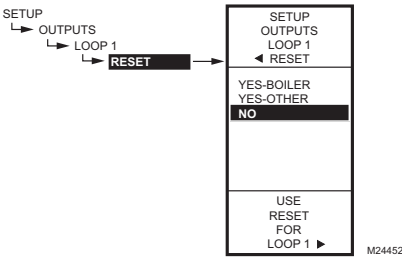

Fig. 43. Setup - Outputs - Loop 1 - Reset.

1.3.4.7. RESET (Loop Reset)

This selection enables the controller's Reset function, and allows each output to be individually programmed for Reset or No Reset.

IMPORTANT

To use the Reset function of the controller, the first loop must be set for Reset.

The RESET choice is offered for all outputs in setup mode, and you can set any or all of them for Reset=YES or Reset=NO. The default is Reset=NO.

For the remaining outputs, if Reset=YES, then these outputs use the reset curve programmed for the first output.

- From the Loop 1 menu, use the ▲ and ▼ buttons to highlight RESET.
 - Press the ► button to display the value.
 - Default: NO
 - Use the ▲ and ▼ buttons to select the value.
 - Press the ► button to accept the value and display the Loop 1 menu.
- If you select YES, then the second loop (and any additional relays) display this Setup option.
 - If you select NO, then No Reset is configured.

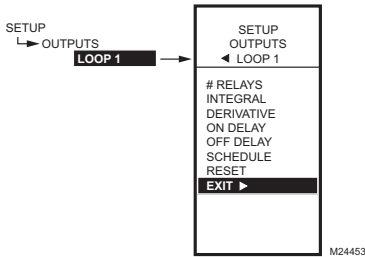

Fig. 44. Setup - Outputs - Loop 1 - Exit.

1.3.4.8. Exit Loop Setup

Use the ▲ and ▼ buttons to highlight EXIT and press the ► button.

If you have additional relay outputs, continue with “1.3.5. Setting up the Relays”. Otherwise, go to “1.4. Exiting Setup” on page 21

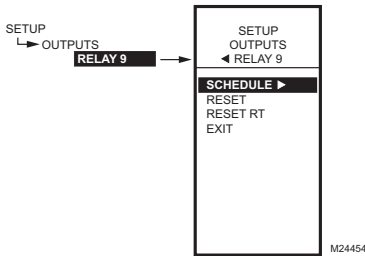

Fig. 45. Setup - Outputs - Relay Menu.

1.3.5. Setting up the Relays

1. From the Outputs menu, use the ▲ and ▼ buttons to highlight the desired relay.
2. Press the ► button to display the selected relay menu.

NOTE: There can be up to two additional relays. For example: If there are 12 total relays, and Loop 1 uses relays 1–4, and Loop 2 uses relays 5–8, the two available additional relays will be 9 and 10. (In this example, relays 11 and 12 are not usable since there can be only two additional relays.)

Continue with the remainder of this section to setup the relay outputs.

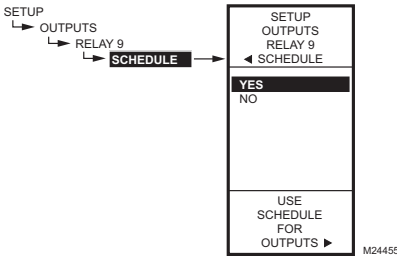

Fig. 46. Setup - Outputs - Relay - Schedule.

1.3.5.1. SCHEDULE

This selection displays only if “Use Sched = YES” is selected during the Output Options setup (see page 15). When selected, individual outputs default to follow the schedule.

1. Press the ► button to display the Schedule values.
2. Use the ▲ and ▼ buttons to select YES or NO. Default: YES
3. Press the ► button to accept the value and return to the Relay menu.

NOTE: If USE SCHED = YES, then the default is YES. See “1.3.3.1. USE SCHED” on page 15.

An individual output can be selected to be controlled or not controlled by the schedule.

If NO is selected, the Setback selection does not appear in the Program menu for this output.

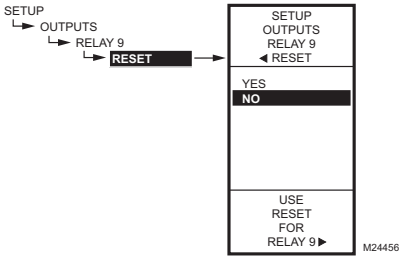

Fig. 47. Setup - Outputs - Relay - Reset.

1.3.5.2. RESET (Relay Reset)

This selection enables or disables reset for the selected relay.

IMPORTANT

To use the Reset function of the controller, the first Loop must be set for Reset.

1. Press the ► button to display the Reset values.
 2. Use the ▲ and ▼ buttons to select YES or NO. Default: NO
 3. Press the ► button to accept the value and return to the Relay menu.
- If you select YES, then the second relay (if available) displays this Setup option and uses the reset curve programmed for the first output Loop.
 - If you select NO, then No Reset is configured for the remaining relay output.

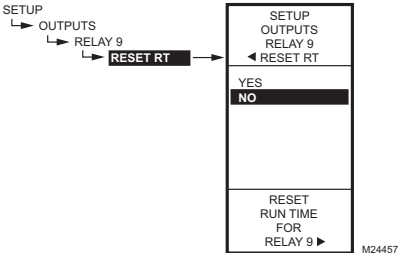

Fig. 48. Setup - Outputs - Relay - Reset Runtime.

1.3.5.3. RESET RT (Run Time)

This selection displays only if “Show RT = YES” is selected during Output Options setup (see page 16).

1. Press the ► button to display the Reset RT values.
2. Use the ▲ and ▼ buttons to select YES or NO. Default: NO
3. Press the ► button to accept the value and return to the Relay menu.

Selecting YES immediately resets the output run time hours to zero for this output. When you subsequently return to this screen, the RESET RT defaults to NO.

NOTE: Run times can be reset to zero for each of the first four independent relays. You must do this for each relay that you want to reset to zero.

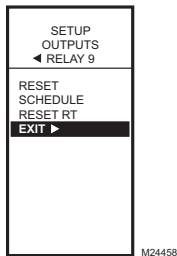

Fig. 49. Setup - Outputs - Relay - Exit.

1.3.5.4. Exit Relay Setup

Press the ◀ button to exit the selected relay set up and return to the Outputs menu.

To setup the next additional relay output go to “1.3.5. Setting up the Relays” on page 20.

If you are finished setting up the additional relay outputs, continue with “1.4. Exiting Setup”.

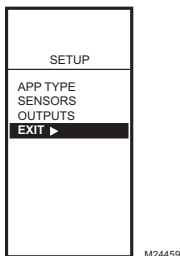

Fig. 50. Setup Exit.

1.4. Exiting Setup

Press the HOME button to exit Setup mode and return to the home screen display. Or, use the ▲ and ▼ buttons to highlight EXIT from the menu and press the ► button.

This completes the Setup procedure. Continue with one of the following sections depending on whether reset is used:

- See “2. Programming Output (Loops and Additional Relays) with No Reset” on page 22.
- See “3. Programming Output (Loops and Additional Relays) with Reset” on page 24.

2. PROGRAMMING OUTPUT (LOOPS AND ADDITIONAL RELAYS) WITH NO RESET

If you are employing Reset, go to “3. Programming Output (Loops and Additional Relays) with Reset” on page 24.

The T775L can be programmed for Reset or No Reset. From the factory, the T775L is programmed for No Reset. This section describes the steps necessary to program the controller for No Reset. Continue with “2.1. Entering Program Mode”.

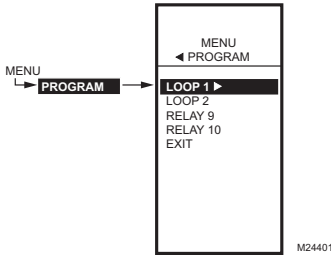

Fig. 51. Program Menu.

2.1. Entering Program Mode

Press the **MENU** button, then select PROGRAM and press the **▶** button to view the Program menu.

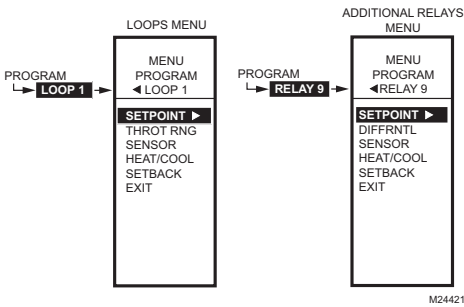

Fig. 52. Program Menus - No Reset.

2.2. Program Menu for Outputs with No Reset

From the Program menu, highlight the Loop or Relay desired and press the **▶** button to view the parameters.

Fig. 52 shows both the Loop and Relay menus.

NOTE: The Setback parameter displays only if scheduling is enabled (see Fig. 31 on page 15) or the DI Option is set to Setback. (see Fig. 33 on page 16).

Continue with “2.2.1. SETPOINT”.

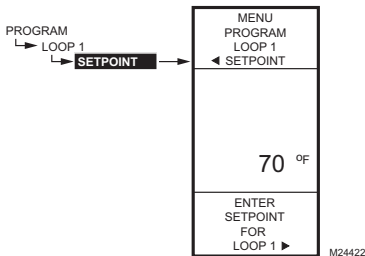

Fig. 53. Program - Setpoint.

2.2.1. SETPOINT

1. From the menu, use the **▲** and **▼** buttons to highlight SETPOINT.
2. Press the **▶** button to display the setpoint value.
3. Use the **▲** and **▼** buttons to increase/decrease the desired setpoint temperature.
Default: 70°F (21°C)
Range: -40°F to 248°F (-40°C to 120°C)
4. Press the **▶** button to accept the setpoint temperature and display the next option.

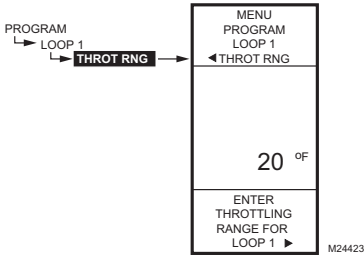

Fig. 54. Program - Throttling Range or Differential.

2.2.2. THROTTLING RANGE or DIFFERENTIAL

Throttling Range is used for Loops, and Differential displays for the Relay outputs.

1. From the menu, use the ▲ and ▼ buttons to highlight THROT RNG or DIFFRNTL.
2. Press the ► button to display the throttling range value.
3. Use the ▲ and ▼ buttons to increase/decrease the desired value.
Default: 20°F (-6.6°C)
Range: 1°F to 150°F (1°C to 66°C)
4. Press the ► button to accept the value and display the next option.

The number of degrees selected for the throttling range is divided between the number of stages. See page 11 for staged operation.

In heating mode, the Differential is below the setpoint. The relay de-energizes when the temperature rises to the setpoint. As the temperature drops to the setpoint minus the Differential, the relay energizes.

In cooling mode, the Differential is above the setpoint. The relay de-energizes when the temperature falls to the setpoint. As the temperature rises to the setpoint plus the Differential, the relay energizes.

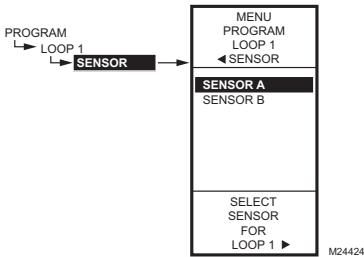

Fig. 55. Program - Sensor.

2.2.3. SENSOR

1. From the menu, use the ▲ and ▼ buttons to highlight SENSOR.
2. Press the ► button to display the sensor selections.
3. Use the ▲ and ▼ buttons to select Sensor A or B.
4. Press the ► button to accept the highlighted sensor and display the next option.

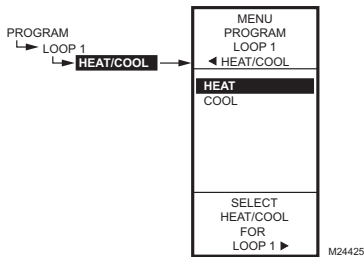

Fig. 56. Program - Heat/Cool.

2.2.4. HEAT/COOL

1. From the menu, use the ▲ and ▼ buttons to highlight HEAT/COOL.
Default: HEAT
2. Press the ► button to display the heat and cool selections.
3. Use the ▲ and ▼ buttons to select Heat or Cool.
4. Press the ► button to accept the highlighted selection and display the next option.

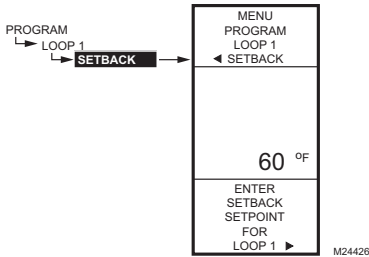

Fig. 57. Program - Setback.

2.2.5. SETBACK

The Setback temperature option displays only if scheduling is enabled (see Fig. 31 on page 15) or the DI Option is set to Setback. (see Fig. 33 on page 16).

This is the desired setpoint temperature that you want to use during setback mode for this output. For example, if your setpoint is 70°F and you want the temperature to drop 10°F during setback mode, enter 60°F as the setpoint for this output.

1. From the menu, use the ▲ and ▼ buttons to highlight SETBACK.
2. Use the ▲ and ▼ buttons to increase/decrease the desired setpoint temperature.
 Default: 60°F (16°C)
 Range: -40°F to 248°F (-40°C to 120°C)
3. Press the ► button to accept the value and display the menu.

2.3. Program Next Output (Loop or Relay)

For the next output (loop or relay), select the desired loop or relay from the Program menu (see Fig. 51 on page 22).

Go to "2.2.1. SETPOINT" on page 22 to continue programming.

When you finish programming the outputs, continue with "2.4. Exit Programming without Reset".

2.4. Exit Programming without Reset

Press the HOME button to leave programming mode and return to the home screen.

This completes the programming procedure for controllers that do not use Reset.

3. PROGRAMMING OUTPUT (LOOPS AND ADDITIONAL RELAYS) WITH RESET

The T775L can be programmed for Reset or No Reset for each output. From the factory, the T775L is programmed for No Reset. This section describes the steps necessary to program the controller for Reset.

To use the Reset feature, Loop 1 must be set to Reset=YES in Setup mode (see "3.1. Setting Up the Controller for Reset"). The reset curve established when programming Loop 1 is then used for the second Loop and the additional relays.

The reset curve established when programming the first Loop is then used for all subsequent Loops and any additional relays that are configured for Reset, and each of those outputs will be offset from this curve.

For all outputs that will follow a reset curve, be sure to configure for Reset=YES in the setup mode. Choose Reset YES or NO for all other outputs you wish to reset, then press the HOME button to record your selection.

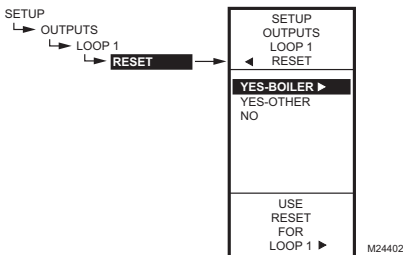

Fig. 58. Reset Setup.

3.1. Setting Up the Controller for Reset

1. Press and hold MENU for five seconds to enter Setup mode.
2. Then choose:
 OUTPUTS ►
 LOOP 1 ►
 RESET ►
 then select YES-BOILER or YES-OTHER (Fig. 58).

You can now press the HOME button to exit Setup mode and continue with "Determining and Setting the Reset Values".

Determining and Setting the Reset Values

NOTE: When using the Reset feature, Sensor A must be sensing the controlled temperature (e.g. Boiler), Sensor B must be sensing the resetting temperature (e.g. outdoor temp).

To program an output (loop or relay) for Reset, refer to the values as shown in the examples below and in Fig. 59. Choose your own appropriate values for Sensor A maximum and minimum and Sensor B maximum and minimum.

Reset Example: (see Fig. 59)

- Sensor A is the boiler sensor and Sensor B is the outdoor sensor.
- Maximum boiler temperature desired is 210°F when the outdoor temperature is 20°F.
- Minimum boiler temperature desired is 160°F when the outdoor temperature is 70°F.
- With the above settings example, when the outdoor temperature is 50°F, the effective setpoint is 180°F.

Setback (optional) Example: (see Fig. 59)

- Setback of -10°F is used to drop the temperature at night by 10°F.
- With the above settings example, when the outdoor temperature is 50°F, the effective setback setpoint is 170°F (180°F setpoint minus the 10°F setback).

NOTE: A single reset curve is programmed for the first output and is used by all outputs and loops setup with RESET=YES.

NOTE: For subsequent outputs (Loop 2 and Relay), a setpoint *offset* is used if that output is also being Reset. See “3.4.1. SETPOINT OFFSET (Loop 2 only)” on page 28.

NOTE: When setback is used, the minimum and maximum boiler temperature setpoints that were entered will also be offset by the setback offset. This may not be desired if it is necessary to maintain the minimum temperature (to avoid condensing) or maximum temperature entered in the reset schedule. In this case, we recommend adjusting the minimum and/or maximum temperature by the offset so that during setback the desired limits are maintained.

When Reset is programmed, the home screen (Fig. 15 on page 9) displays the calculated Heat/Cool setpoint(s) for the Loop and Relay outputs based on the reset curve.

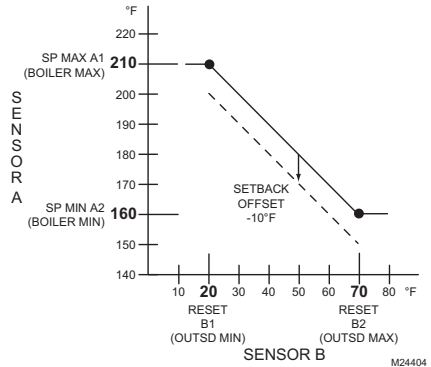

Fig. 59. Reset Curve for Loop 1 with Setback Offset.

The remainder of this section beginning with “3.2. Entering Program Mode” describes the individual parameters for configuring outputs with Reset.

For your reference, the following Reset programming procedure uses the values in Fig. 59.

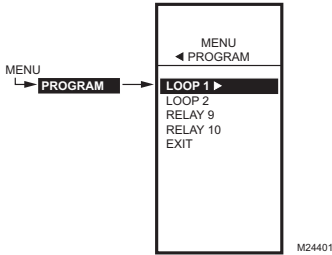

Fig. 60. Program Menu.

3.2. Entering Program Mode

Press the **MENU** button, then select **PROGRAM** and press the **▶** button to view the Program menu.

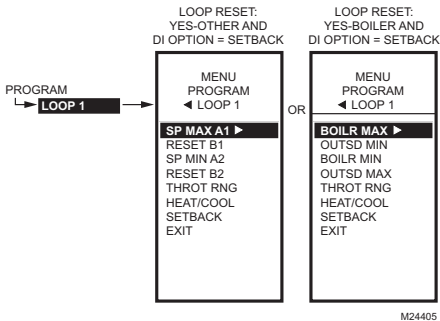

Fig. 61. Setpoint Values for Reset and Setback.

3.3. Program Menus for Loops with Reset

Press the **MENU** button, select **PROGRAM**, then select **Loop 1** and press the **▶** button to view the parameters.

Fig. 61 shows both of the Loop 1 menus. Your menu is the one chosen in Fig. 58 on page 24

The Reset settings “3.3.1. SP MAX A1 or BOILER MAX (Setpoint maximum for Sensor A)” through “3.3.4. RESET B2 or OUTSD MAX (Sensor B value when at MIN A2 Setpoint)” are programmed for the first loop and these settings apply to all outputs that are configured for Reset. See Fig. 59 on page 25 for the reset curve values used in the following section.

NOTE: The Setback parameter displays only if scheduling is enabled (see Fig. 31 on page 15) or the DI Option is set to Setback. (see Fig. 33 on page 16).

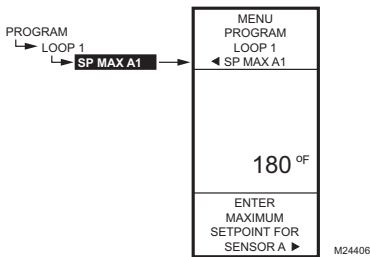

Fig. 62. Program - Sensor A Max. Setpoint.

3.3.1. SP MAX A1 or BOILER MAX (Setpoint maximum for Sensor A)

1. From the menu, use the **▲** and **▼** buttons to highlight **SP MAX A1**.
2. Press the **▶** button to display the maximum setpoint value.
3. Use the **▲** and **▼** buttons to increase/decrease the desired maximum setpoint temperature.
Default: 180°F (82°C)
Range: -40°F to 248°F (-40°C to 120°C)
4. Press the **▶** button to accept the setpoint temperature and display the next option.

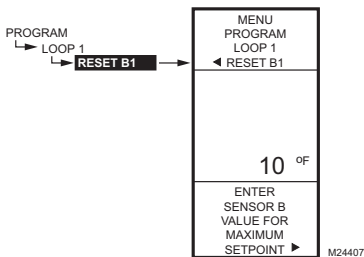

Fig. 63. Program - Sensor B Max. Setpoint.

3.3.2. RESET B1 or OUTSD MIN (Sensor B value when at SP MAX A1 Setpoint)

1. From the menu, use the **▲** and **▼** buttons to highlight **RESET B1** or **OUTSD MIN**.
2. Press the **▶** button to display the setpoint value.
3. Use the **▲** and **▼** buttons to increase/decrease the desired setpoint temperature.
Default: 10°F (-12°C)
Range: -40°F to 248°F (-40°C to 120°C)
4. Press the **▶** button to accept the value and display the next option.

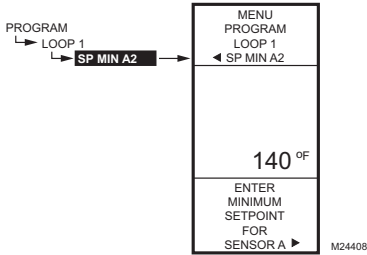

Fig. 64. Program - Sensor A Min. Setpoint.

3.3.3. SP MIN A2 or BOILER MIN (Setpoint minimum for Sensor A)

1. From the menu, use the ▲ and ▼ buttons to highlight SP MIN A2.
2. Press the ► button to display the setpoint value.
3. Use the ▲ and ▼ buttons to increase/decrease the desired minimum setpoint temperature.
Default: 140°F (60°C)
Range: -40°F to 248°F (-40°C to 120°C)
4. Press the ► button to accept the setpoint temperature and display the next option.

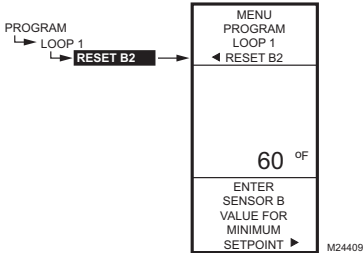

Fig. 65. Program - Sensor B Min. Setpoint.

3.3.4. RESET B2 or OUTSD MAX (Sensor B value when at MIN A2 Setpoint)

1. From the menu, use the ▲ and ▼ buttons to highlight RESET B2.
2. Press the ► button to display the setpoint value.
3. Use the ▲ and ▼ buttons to increase/decrease the desired setpoint temperature.
Default: 60°F (16°C)
Range: -40°F to 248°F (-40°C to 120°C)
4. Press the ► button to accept the value and display the next option.

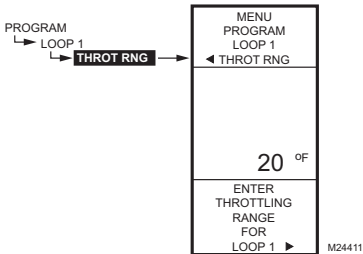

Fig. 66. Program - Throttling Range.

3.3.5. THROTTLING RANGE

The number of degrees selected for the throttling range is divided between the number of stages. See page 11 for Staged Operation.

1. From the menu, use the ▲ and ▼ buttons to highlight THROT RNG.
2. Press the ► button to display the throttling range value.
3. Use the ▲ and ▼ buttons to increase/decrease the desired value.
Default: 20°F (-6.6°C)
Range: 1°F to 150°F (1°C to 66°C)
4. Press the ► button to accept the value and display the next option.

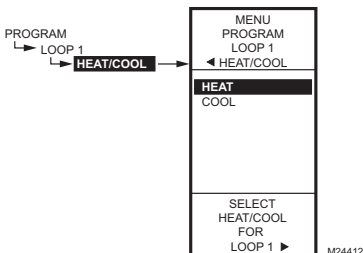

Fig. 67. Program - Heat/Cool Selection.

3.3.6. HEAT/COOL

1. From the menu, use the ▲ and ▼ buttons to highlight HEAT/COOL.
2. Press the ► button to display the heat and cool selections.
3. Use the ▲ and ▼ buttons to select Heat or Cool.
4. Press the ► button to accept the highlighted selection and display the next option.

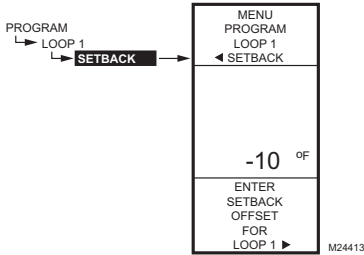

Fig. 68. Program - Setback (Offset).

3.3.7. SETBACK OFFSET (if configured)

The Setback temperature option displays only if Scheduling is enabled (see Fig. 31 on page 15) or the DI Option is set to Setback (see Fig. 33 on page 16).

This value is the number of degrees plus (+) or minus (-) that you want the temperature to be offset from the setpoint.

For example, If you want the temperature to be 10°F less than the setpoint during setback mode, enter -10°F. In normal operations for heating, the offset will be negative. For cooling, the offset will be a positive value.

1. From the menu, use the ▲ and ▼ buttons to highlight SETBACK.
2. Use the ▲ and ▼ buttons to increase/decrease the desired setpoint temperature.
Default: 0°F
Range: -150°F to 150°F (-101°C to 66°C)
3. Press the ► button to accept the value and display the menu.

This completes the programming of Loop 1. To program Loop 2, continue with "3.4. Loop 2".

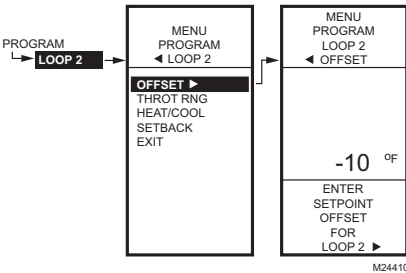

Fig. 69. Program - Setpoint Offset (Loop 2 only).

3.4. Loop 2

For the second loop (if it is configured for Reset), the Offset parameter displays on the Program menu as shown in Fig. 69.

3.4.1. SETPOINT OFFSET (Loop 2 only)

This value is the number of degrees plus (+) or minus (-) that you want the temperature to be offset from the Loop 1 setpoint. See Fig. 70. For example, If you want the Loop 2 setpoint to be 10°F less than the Loop 1 setpoint, enter -10°F.

1. From the menu, use the ▲ and ▼ buttons to highlight OFFSET.
2. Press the ► button to display the value.
3. Use the ▲ and ▼ buttons to increase/decrease the desired temperature.
OFFSET Default: 0°F
OFFSET Range: -150°F to 150°F (-101°C to 66°C)
4. Press the ► button to accept the value and display the next option.

3.4.2. Loop 2 Programming

To complete the programming of Loop 2, perform the procedures in "3.3.5. THROTTLING RANGE" through "3.3.7. SETBACK OFFSET (if configured)" beginning on page 27.

3.4.3. Exit Loop Programming with Reset

When you finish programming the loop(s), press the HOME button to leave programming mode and return to the home screen.

If you have additional relays configured, continue with "3.5. Program Menus for the Additional Relays with Reset" on page 29.

If there are no additional relays, continue with "3.7. Exit Programming with Reset" on page 30.

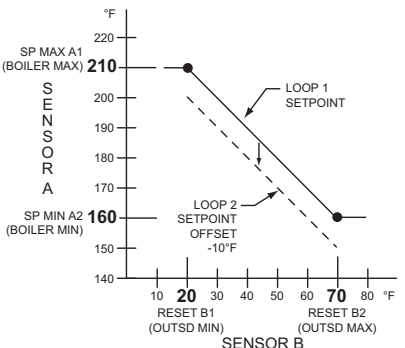

Fig. 70. Reset Curve with Offset for Loop 2.

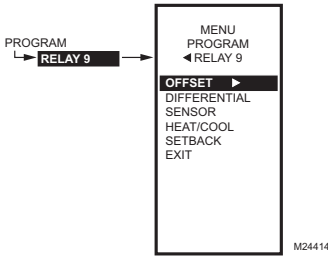

Fig. 71. Program Menus for Relays.

3.5. Program Menus for the Additional Relays with Reset

Press the **MENU** button, select **PROGRAM**, then select an available relay to view the parameters. Fig. 71 shows the example for relay 9. If Relays are not set for Reset in Setup mode, simply enter the setpoint desired.

Up to two additional two relays can be available for independent on-off control. Examples of Loop and Relay configurations are:

- Number of relays = 8. Loop 1 uses relays 1-3, and Loop 2 uses relays 3-6. The remaining two relays (7 and 8) are available for use.
- Number of relays = 11. Loop 1 uses relays 1-5, and Loop 2 uses relays 6-10. The remaining relay (11) is available for use.
- Number of relays = 12. Loop 1 uses relays 1-4, and Loop 2 uses relays 5-8. Relays 9 and 10 are available for use, but in this case, relays 11 and 12 are not usable.

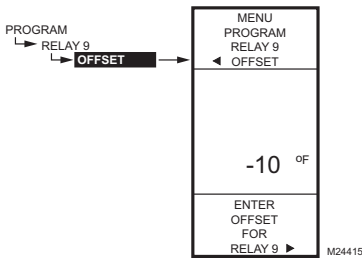

Fig. 72. Program - Setpoint Offset.

3.5.1. SETPOINT OFFSET

This value is the number of degrees plus (+) or minus (-) that you want the additional relay to be offset from the setpoint curve created for Loop 1. For example, If you want the temperature to be 10°F less than the Loop 1 setpoint, enter -10°F.

1. From the menu, use the ▲ and ▼ buttons to highlight OFFSET.
2. Press the ► button to display the value.
3. Use the ▲ and ▼ buttons to increase/decrease the desired setpoint temperature.
OFFSET Default: 0°F
OFFSET Range: -150°F to 150°F (-101°C to 66°C)
4. Press the ► button to accept the stepping and display the next option.

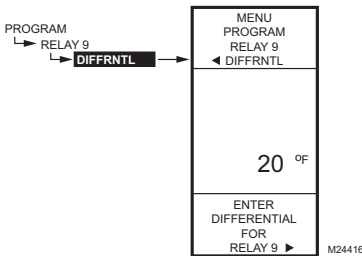

Fig. 73. Program - Differential.

3.5.2. DIFFERENTIAL

Differential is used for the additional Relay outputs.

1. From the menu, use the ▲ and ▼ buttons to highlight DIFFRNTL.
2. Press the ► button to display the differential value.
3. Use the ▲ and ▼ buttons to increase/decrease the desired value.
Default: 20°F (-6.6°C)
Range: 1°F to 150°F (1°C to 66°C)
4. Press the ► button to accept the value and display the next option.

In heating mode, the Differential is below the setpoint. The relay de-energizes when the temperature rises to the setpoint. As the temperature drops to the setpoint minus the Differential, the relay energizes.

In cooling mode, the Differential is above the setpoint. The relay de-energizes when the temperature falls to the setpoint. As the temperature rises to the setpoint plus the Differential, the relay energizes.

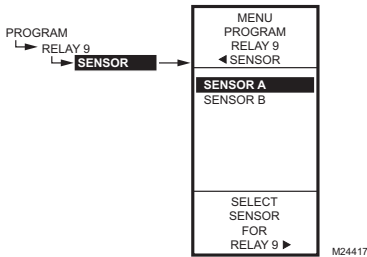

Fig. 74. Program - Sensor.

3.5.3. SENSOR

1. From the menu, use the ▲ and ▼ buttons to highlight SENSOR.
2. Press the ► button to display the sensor selections.
3. Use the ▲ and ▼ buttons to select Sensor A or B.
4. Press the ► button to accept the highlighted sensor and display the next option.

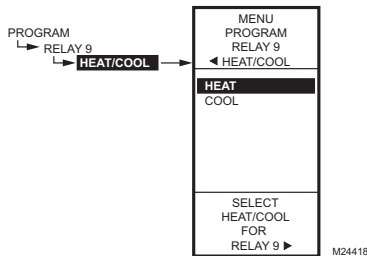

Fig. 75. Program - Heat/Cool Selection.

3.5.4. HEAT/COOL

1. From the menu, use the ▲ and ▼ buttons to highlight HEAT/COOL.
Default: HEAT
2. Press the ► button to display the heat and cool selections.
3. Use the ▲ and ▼ buttons to select Heat or Cool.
4. Press the ► button to accept the highlighted selection and display the next option.

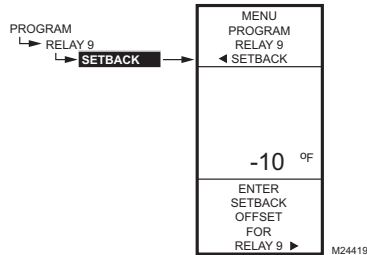

Fig. 76. Program - Setback (Offset).

3.5.5. SETBACK OFFSET

The Setback temperature option displays only if scheduling is enabled (see Fig. 31 on page 15) or the DI Option is set to Setback. (see Fig. 33 on page 16).

This value is the number of degrees plus (+) or minus (-) that you want the temperature to be offset from this relay's setpoint.

For example, If you want the temperature to be 10°F less than the relay's setpoint during setback mode, enter -10°F. In normal operations for heating, the offset will be negative. For cooling, the offset will be a positive value.

1. From the menu, use the ▲ and ▼ buttons to highlight SETBACK.
2. Use the ▲ and ▼ buttons to increase/decrease the desired setpoint temperature.
Default: 0°F
Range: -150°F to 150°F (-101°C to 66°C)
3. Press the ► button to accept the value and display the menu.

3.6. Program Next Relay

If you have a second relay output, select that relay from the Program menu, and go to "3.5. Program Menus for the Additional Relays with Reset" on page 29.

When you finish programming the relay outputs, continue with "3.7. Exit Programming with Reset".

3.7. Exit Programming with Reset

Press the HOME button to leave programming mode and return to the home screen.

This completes the programming procedure for the additional relays that use Reset.

4. SCHEDULING

Scheduling provides the ability to set daily temperature settings for up to two events per day. Typically, these are the daytime (setpoint) and the nighttime (setback) settings.

IMPORTANT

To enable Scheduling, you must first enter Setup mode (press and hold the **MENU** button for 5 seconds), select **OUTPUTS**, select **OPTIONS**, select **USE SCHED**, and then select **YES**. (see “1.3.3.1. USE SCHED” on page 15).

IMPORTANT

To properly account for Daylight Saving time, be sure to set the Date **before** setting the Time. See “4.2.2. SET DATE” on page 32.

NOTE: The T775L controller interface is intuitive. You may want to use this procedure simply as a reference to locate the particular option or parameter of interest.

NOTE: Each loop and additional relay output can be independently scheduled or not. For loops, see “1.3.4.6. SCHEDULE” on page 19. For relay outputs, see “1.3.5.1. SCHEDULE” on page 20.

NOTES:

1. If you press the **HOME** button or there is no keypad activity for four minutes, you exit Schedule mode and return to the home screen.
2. If you press the **MENU** button, you exit Schedule mode and return to the menu.

To create or change a schedule, you use the —

- **Left arrow button (◀)** to scroll backward through the Schedule menus
- **Right arrow button (▶)** to select the highlighted menu item and display its content
- **Up and Down arrow buttons (▲ and ▼)** to scroll up and down through a list of items or to increase or decrease the value of a displayed schedule parameter

Creating a Schedule

To create a schedule, perform the following in the order listed:

1. Enable Scheduling in Setup mode — see “1.3.3.1. USE SCHED” on page 15
2. Enter Schedule mode — see “4.1. Entering Schedule Mode”
3. Set the Schedule Options — see “4.2. OPTIONS”
4. Set Individual Schedules — begin with “4.3. Setting Individual Schedules” on page 33
5. Exit Schedule Mode — see “4.4. Exiting Scheduling Mode” on page 34

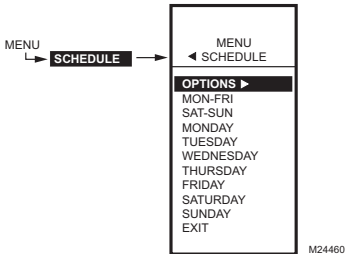

Fig. 77. Schedule - Menu.

4.1. Entering Schedule Mode

Press the **MENU** button, then select **SCHEDULE** and press the **▶** button to view the Schedule menu.

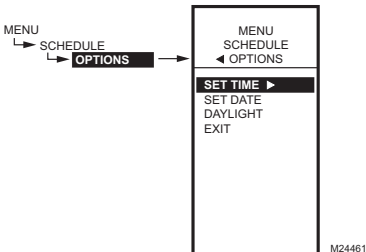

Fig. 78. Schedule - Options Menu.

4.2. OPTIONS

1. From the Schedule menu, use the **▲** and **▼** buttons to highlight **OPTIONS**.
2. Press the **▶** button to display the Options menu.

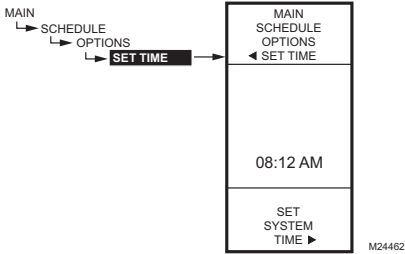

Fig. 79. Schedule - Options - System Time.

4.2.1. SET TIME

Setting the system time is required to enable the controller to follow daylight saving time.

IMPORTANT

Set the Date before setting the Time. See "4.2.2. SET DATE".

1. From the Options menu, use the ▲ and ▼ buttons to highlight SET TIME.
2. Press the ► button to display the current system time setting.
3. Use the ► button to cycle between the hour, minute, and AM/PM values.
4. Use the ▲ and ▼ buttons to increase/decrease the desired value for the hour, minute, and AM/PM.
5. Press the ◀ button to accept the Time and return to the Options menu.

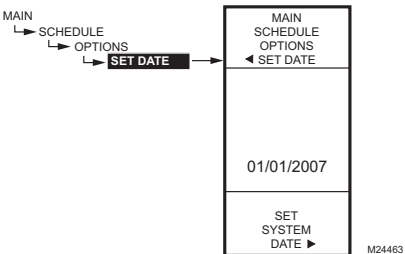

Fig. 80. Schedule - Options - System Date.

4.2.2. SET DATE

Setting the system date is required to enable the controller to follow daylight saving time.

IMPORTANT

To properly account for Daylight Saving time, be sure to set the Date before setting the Time.

1. From the Options menu, use the ▲ and ▼ buttons to highlight SET DATE.
2. Press the ► button to display the current system date setting.
3. Use the ► button to cycle between the month, day, and year values.
4. Use the ▲ and ▼ buttons to increase/decrease the desired value for the month, day, and year.
5. Press the ◀ button to accept the Date and return to the Options menu.

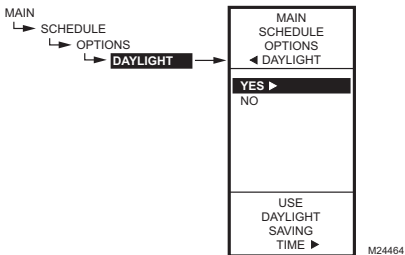

Fig. 81. Schedule - Options - Daylight Saving Time.

4.2.3. DAYLIGHT (daylight saving time)

1. From the Options menu, use the ▲ and ▼ buttons to highlight DAYLIGHT.
2. Press the ► button to display the current system setting for daylight saving time.
3. Use the ▲ and ▼ buttons to select YES or NO.
Default: YES
4. Press the ► button to accept the value and return to the Options menu.
5. From the Options menu, use the Use the ▲ and ▼ buttons to highlight EXIT.
6. Press the ► button to return to the Schedule menu.

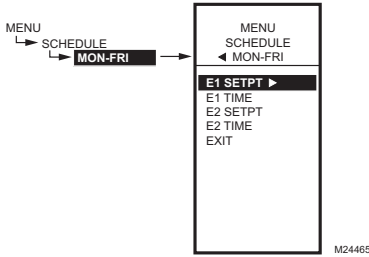

Fig. 82. Schedule Event Menu (Showing MON-FRI).

4.3. Setting Individual Schedules

As shown in the Schedule menu (Fig. 77 on page 31), schedules can be set for the following time periods:

- Monday through Friday
- Saturday and Sunday
- Individual days of the week

1. From the Schedule menu, use the ▲ and ▼ buttons to highlight the desired time period.
2. Press the ► button to display the Schedule menu for the selected time period.

For each selected time period, the schedule event (E1 and E2) parameters are exactly the same as shown in Fig. 82.

SCHEDULING EXAMPLE

Setting the schedule is independent of the temperature settings for the relay outputs. Table 4 illustrates a weekly schedule for daytime (setpoint) and night time (setback) use and shows the factory default settings.

Table 4. Mon-Fri Schedule Defaults

DAY	EVENT	SETPT ACTION	TIME
Mon-Fri	Event 1 (E1)	Setpoint	6:00 AM ^a
Mon-Fri	Event 2 (E2)	Setback	6:00 PM ^b
Sat-Sun	Not used; remains in Setback from the Mon-Fri E2 settings		

^a Setpoint time span is 6:00 AM until 5:59 PM because setback starts at 6:00 PM.

^b Setback time span is 6:00PM until 5:59 AM because setpoint starts at 6:00 AM.

To set a schedule, continue with “4.3.1. E1 SETPT (setpoint for event 1)”.

The remainder of this section shows the MON-FRI menu, but the menu selections are the same for any time period.

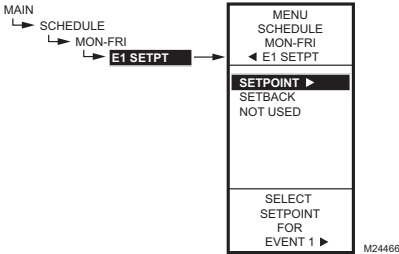

Fig. 83. Schedule - Event 1 Setpoint.

4.3.1. E1 SETPT (setpoint for event 1)

1. From the selected time period menu, use the ▲ and ▼ buttons to highlight E1 SETPT.
2. Press the ► button to display the setpoint options.
3. Use the ▲ and ▼ buttons to highlight the desired option.
4. Press the ► button to accept the value and return to the selected time period menu.

Continue with “4.3.2. E1 TIME (time for event 1)” on page 34.

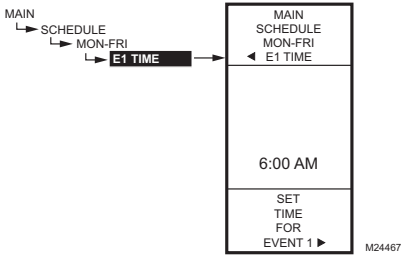

Fig. 84. Schedule - Event 1 Time.

4.3.2. E1 TIME (time for event 1)

1. From the selected time period menu, use the ▲ and ▼ buttons to highlight E1 TIME.
2. Press the ► button to display the current time setting for event 1.
3. Use the ► button to cycle between the hour, minute, and AM/PM values.
4. Use the ▲ and ▼ buttons to increase/decrease the desired value for the hour, minute, and AM/PM.
5. Press the ◀ button to accept the time and return to the selected time period menu.

4.3.3. E2 SETPOINT (setpoint for event 2)

Creating the setpoint for event 2 is accomplished the same way as the first event. See "4.3.1. E1 SETPT (setpoint for event 1)" on page 33.

4.3.4. E2 TIME (time for event 2)

Creating the time for event 2 is accomplished the same way as the first event. See "4.3.2. E1 TIME (time for event 1)".

4.3.5. EXIT (exit from selected time period settings)

After entering the time for event 2, use the ◀ button to exit the schedule time period and return to the Schedule menu (Fig. 77 on page 31) to select a different time period.

When you finish scheduling the time periods, continue with "4.4. Exiting Scheduling Mode".

4.4. Exiting Scheduling Mode

Press the **HOME** button to exit the Schedule menu and return to the home screen display.

This completes the Scheduling procedure.

SUMMARY MENU

The Summary menu provides the ability to view the schedule (E1 and E2 times) for each relay for each day of the week.

NOTE: Scheduling must be enabled for the Summary menu to display. Enabling scheduling is determined in the Setup process for the Output Options (see "1.3.3. OPTIONS" on page 15).

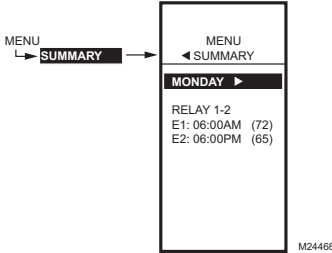

Fig. 85. Summary Example - Monday Settings.

For each relay, the Summary display indicates the time and temperature (in parenthesis) for each of the two scheduled events E1 and E2.

1. Press the **MENU** button to view the menu.
2. Use the **▲** and **▼** buttons to highlight **SUMMARY**.
3. Press the **▶** button to display the Summary settings.
4. Use the **▶** button to scroll forward through each day of the week (Monday, Tuesday, Wednesday, Thursday, Friday, Saturday, and Sunday).
5. While viewing a specific day, use the **▲** and **▼** buttons to cycle through the individual relay schedules for that day.

When finished, press the **HOME** button to return to the home display screen.

If programmed for Reset control, the Summary setpoints display as "RES" instead of a temperature value. For example, the display would show:

```

MONDAY
STAGES
E1: 06:00AM (RES) - indicating Reset
E2: 06:00PM (05) - setback/offset degrees
  
```

TROUBLESHOOTING

Power Loss

The date and time settings are retained for 24 hours after a power outage. After a power loss of more than 24 hours, the date and time settings may need to be reentered. All other settings are stored permanently.

Errors and Diagnostics

The controller provides an error message and diagnostic status as described below.

Error Message

There is a two-character error code that displays in response to controller software problems:

EE

EEPROM Failure— The values read back from the EEPROM are not the same as written into the EEPROM. This error cannot be field repaired. Replace the device.

Diagnostic Messages

There are two diagnostic messages that can display in response to sensor problems. The diagnostic codes that can flash on the display are:

--

Sensor Open or Shorted— Two dashes display when a sensor (typically temperature) is open or shorted. An open circuit is considered anything greater than 1570 ohms (greater than 300F), shorted anything less than 770 ohms (less than -73F). Which-ever stages are operating with this sensor cease to control (meaning relays go to OFF and proportional outputs go to zero percent).

This message can also mean that the sensor is programmed, but not physically connected (open).

-60°F or 270°F (-51°C or 132°C) Blinking

Temperature Out of Range— The temperature display blinks when the sensed temperature range is outside of the display range, below -60°F (-51°C) or above 270°F (132°C). The displayed value remains at that displayed limit and control continues. Controller continues to function unless an open or shorted state is detected.

Blinking relay status

Relay Minimum Off Time is Active — On the home screen, each relay's indicator (■) blinks while the relay's minimum off time is active.

SPECIFICATIONS

Power: 24, 120, or 240 Vac; 50/60 Hz;

A separate earth ground is required for any power source.

Power Consumption:

- 8 VA maximum at 60 Hz
- 10 VA maximum at 50 Hz

Operating & Storage Temperature Ambient Rating:

- -40° F to 125° F (-40° C to 52° C) @ 50 Hz
- -40° F to 140° F (-40° C to 60° C) @ 60 Hz

Relative Humidity: 5% to 95% non-condensing

Relay Contact Output Ratings (N.O. and N.C.):

- 1/2 hp; 9.8 AFL, 58.8 ALR @ 120 Vac
- 1/2 hp; 4.9 AFL, 29.4 ALR @ 240 Vac
- 125 VA pilot duty @ 120/240 Vac
- 10A @ 24 Vac (resistive)

DoC

Emissions Compliance

EN 55022: 2006
 CISPR 22: 2006
 VCCI V-3/2006.04
 ICES-003, Issue 4: 2004
 FCC PART 15 SUBPART B Class B Limit

Immunity Compliance

EN 61000-6-1: 2001 covering
 EN 61000-4-2: 1995 + A1: 1998 + A2: 2001
 EN 61000-4-3: 2002
 EN 61000-4-4: 2004
 EN 61000-4-5: 1995 + A1: 2001
 EN 61000-4-6: 1996 + A1: 2001
 EN 61000-4-8: 1993 + A1: 2001
 EN 61000-4-11 2nd Ed.: 2004

Safety Compliance

UL 60730-1 for US and Canada

FCC Compliance Statement:

This equipment has been tested and found to comply with limits for a Class B digital device, pursuant to Part 15 of the FCC rules. These limits are designed to provide reasonable protection against harmful interference in residential installations. This equipment generates, uses, and can radiate radio frequency energy, and if not installed and used in accordance with the instructions, may cause harmful interference to radio communications.

However, there is no guarantee that interference will not occur in a particular installation. If this equipment does cause interference to radio or television equipment reception, which can be determined by turning the equipment off and on, the user is encouraged to try to correct the interference by one or more of the following measures:

- Reorient or relocate the receiving antenna
- Move the equipment away from the receiver
- Plug the equipment into an outlet on a circuit different from that to which the receiver is connected
- Consult the dealer or an experienced radio/television technician for additional suggestions

You are cautioned that any change or modifications to the equipment not expressly approved by the party responsible for compliance could void Your authority to operate such equipment.

This device complies with Part 15 of the FCC Rules. Operation is subjected to the following two conditions 1) this device may not cause harmful interference and 2) this device must accept any interference received, including interference that may cause undesired operation.

Automation and Control Solutions

Honeywell International Inc.
 1985 Douglas Drive North
 Golden Valley, MN 55422
 customer.honeywell.com

Honeywell Limited-Honeywell Limitée
 35 Dynamic Drive
 Toronto, Ontario M1V 4Z9

® U.S. Registered Trademark
 © 2008 Honeywell International Inc.
 62-0257-05 K.K. Rev. 11-08



Printed in U.S.A. on recycled paper containing at least 10% post-consumer paper fibers.

Honeywell