



M SERIES



MicroM

# MODERNIZATION ADAPTER 60-1765

Assists with the replacement of an  
R4795 with the M-Series II or  
MicroM Control System

## DESCRIPTION

Modernize an existing R4795 Control installation by installing a Fireye M-Series II or MicroM Control and improve the operational safety and reliability of the control.

## SPECIAL FEATURES

	M-SERIES II	MicroM
Flame Detection	UV Fame Rod Photo Cell	UV Fame Rod Photo Cell UV Self-Check Infrared
Safety Timings	Solid State Logic	Micro Processor Controlled
Temperature Range	-40°F to +125°F	-40°F to +140°F
Indication	Status LED's	Status LED's
Diagnostics	Alarm LED	Smart LED's
Design Footprint	Modular	Modular
Prepurge	Selectable 7, 30, 60, 90 seconds	Selectable 7, 30, 60, 90 seconds
Trial for Ignition	Selectable 5 or 10 seconds	Selectable 5 or 10 seconds
Flame Failure Response Time	0.8 or 2-4 seconds	0.8 or 3 seconds
Compatibility	No Re-wiring required	No Re-wiring required
Recycle/Non-recycle	Selectable	Selectable
Fireye Bulletin	C-4000	MC-5000



**CAUTION: Installer must be a trained safety control technician. Verify that electrical power is disconnected before starting installation.**

1. Loosen the 10 chassis retaining screws and remove the RA890 from the wiring base. Verify that the installation operates at 120 volts.

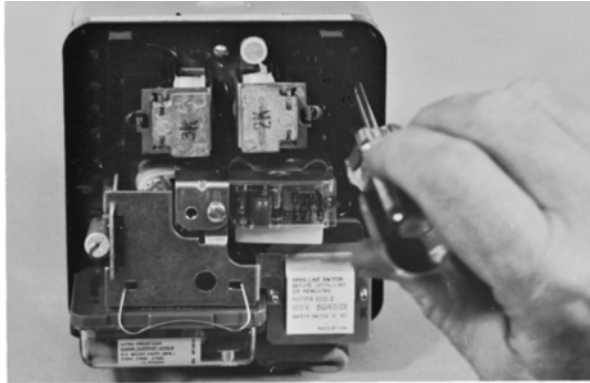

2. Verify that the wires connected to terminals T7, T6 on the Q270 wiring base are rated for line voltage and that all switches and controllers in this circuit are rated for line voltage.

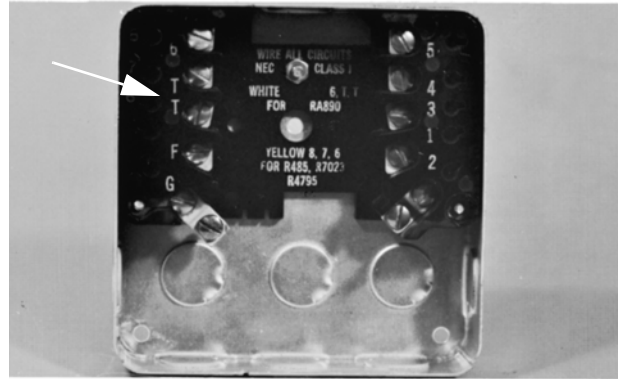

3. If a Fireye MAUV or MEUV amplifier is to be installed, remove the ground strap from terminals G on the Q270 Wiring base. If a MART or MERT amplifier is to be installed, do not remove the ground strap.



4. The Fireye M-Series II and MicroM Controls provides a line voltage alarm circuit that is powered following a safety lockout. If the R4795 installation includes a line voltage alarm circuit, reconnect it as follows:

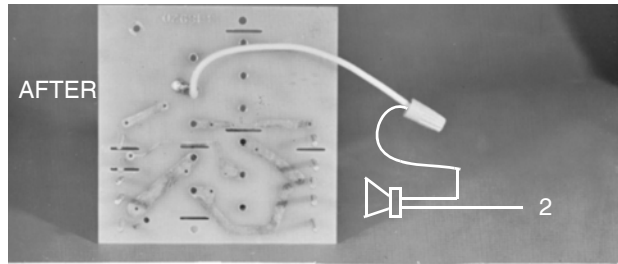
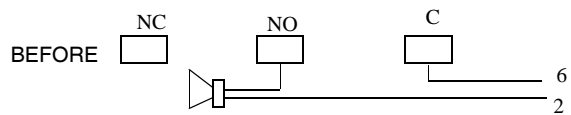

5. If a Fireye MAUV or MEUV amplifier is to be installed, mount and wire a Fireye UV1A, UV1B or UV2 Flame Scanner following the instructions provided in Fireye Bulletin C-4000 or MC-5000. If a Fireye MART or MERT amplifier is to be installed, use the existing flame rod or photocell. Refer to cross reference listing for the proper selection of components.

6. Install the Fireye 60-1765 Modernization Adapter and tighten the 10 retaining screws.

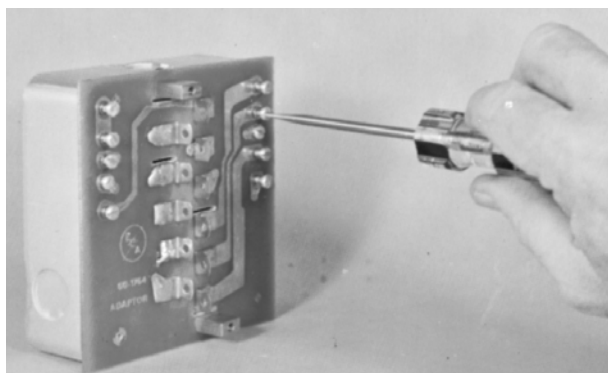

7. Install the Fireye M-Series II or MicroM Control and tighten the two chassis retaining screws.

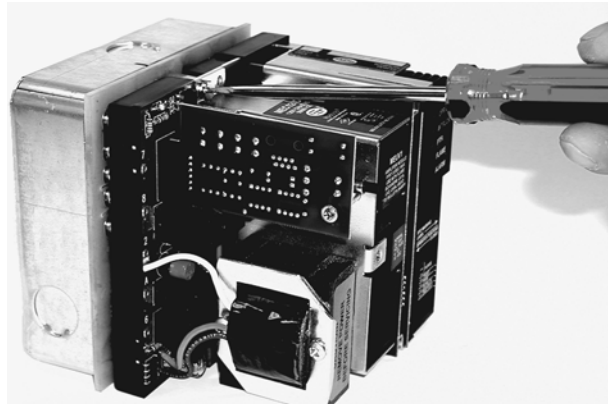



8. Wrap the supplied self-stick gasket around adapter to provide insulation.

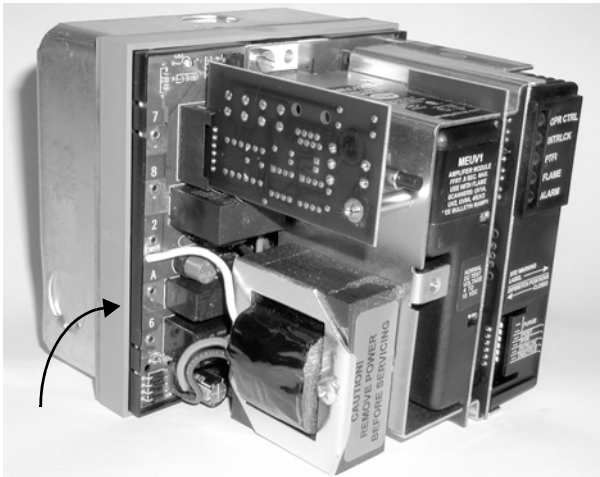

9. Install the Fireye cover and tighten the retainer.



10. For assistance with non-standard installation, contact your Fireye Distributor.

**M-SERIES TO M-SERIES II TO MICROM CROSS REFERENCE LISTING**

M-SERIES Part Number	M-SERIES II REPLACEMENT MODULES				MicroM REPLACEMENT MODULES			
	Chassis	Amplifier	Programmer	Programmer Dipswitch #8	Chassis	Amplifier	Programmer	Programmer Dipswitch #6
UVM2	MC120	MAUV1	MP230	OFF	MEC120	MEUV4	MEP230	C
TFM2	MC120	MART1	MP230	OFF	MEC120	MERT4	MEP230	C
UVM3	MC120	MAUV1	MP230	ON	MEC120	MEUV4	MEP230	O
TFM3	MC120	MART1	MP230	ON	MEC120	MERT4	MEP230	O
UVM3H	MC120	MAUV1	MP230H	ON	MEC120	MEUV4	MEP230H	O
TFM3H	MC120	MART1	MP230H	ON	MEC120	MERT4	MEP230H	O
UVM5	MC120	MAUV1	MP560	ON	MEC120	MEUV4	MEP560	O
UVM6	MC120	MAUV1	MP560	See Note #2	MEC120	MEUV4	MEP560	C
- Dipswitch #8 sets Recycle / Non-Recycle Operation. - Note #1: For Standing Pilot, clip out red jumper on MP100. - Note #2: Dipswitch #8 ON when red jumper of UVM6 is clipped.					- Dipswitch #6 sets Recycle / Non-Recycle Operation. (O = Non-Recycle, C = Recycle)			

PURGE TIME	PTFI TIME	M-Series II PROGRAMMER DIPSWITCH SETTINGS							MicroM PROGRAMMER DIPSWITCH SETTINGS			
		#1	#2	#3	#4	#5	#6	#7	#1	#2	#4	#6
7	5	ON	OFF	OFF	OFF	OFF	ON	OFF	C	C	C	C
7	5	OFF	ON	OFF	OFF	OFF	ON	OFF	C	C	C	C
30	5	OFF	OFF	ON	OFF	OFF	ON	OFF	O	C	C	C
7	10	OFF	ON	OFF	OFF	OFF	OFF	ON	C	C	O	O
90	5	OFF	OFF	ON	ON	OFF	ON	OFF	O	O	C	C
30	10	OFF	OFF	ON	OFF	OFF	OFF	ON	O	C	O	O
60	10	OFF	OFF	OFF	ON	OFF	OFF	ON	C	O	O	O
90	10	OFF	OFF	ON	ON	OFF	OFF	ON	O	O	O	O
- Dipswitches #1 through #5 set Purge Timing - Dipswitches #6 and #7 set TFI Timing									- Dipswitches #1 through #2 set Purge Timing - Dipswitch #4 sets TFI Timing - Dipswitch #6 set Recycle/Non-Recycle			

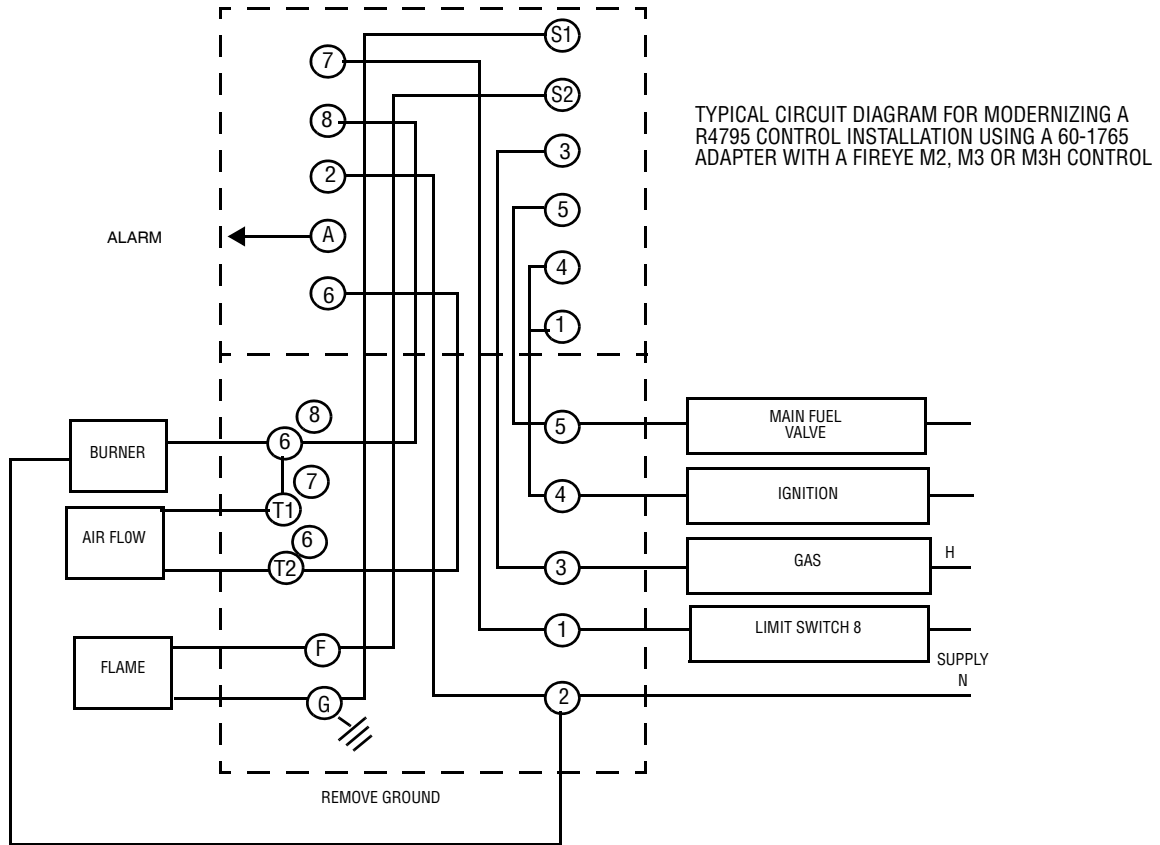

TYPICAL CIRCUIT DIAGRAM FOR MODERNIZING A R4795 CONTROL INSTALLATION USING A 60-1765 ADAPTER WITH A FIREYE M2, M3 OR M3H CONTROL

## NOTICE

When Fireye products are combined with equipment manufactured by others and/or integrated into systems designed or manufactured by others, the Fireye warranty, as stated in its General Terms and Conditions of Sale, pertains only to the Fireye products and not to any other equipment or to the combined system or its overall performance.

## WARRANTIES

FIREYE guarantees for *one year from the date of installation or 18 months from date of manufacture* of its products to replace, or, at its option, to repair any product or part thereof (except lamps, electronic tubes and photocells) which is found defective in material or workmanship or which otherwise fails to conform to the description of the product on the face of its sales order. **THE FOREGOING IS IN LIEU OF ALL OTHER WARRANTIES AND FIREYE MAKES NO WARRANTY OF MERCHANTABILITY OR ANY OTHER WARRANTY, EXPRESS OR IMPLIED.** Except as specifically stated in these general terms and conditions of sale, remedies with respect to any product or part number manufactured or sold by Fireye shall be limited exclusively to the right to replacement or repair as above provided. In no event shall Fireye be liable for consequential or special damages of any nature that may arise in connection with such product or part.



FIREYE®  
3 Manchester Road  
Derry, New Hampshire 03038 USA  
www.fireye.com

MM-2  
JUNE 2003  
Supersedes Sept. 2001

