

# VP527A Pneumatic Water Valve

## SERVICE DATA

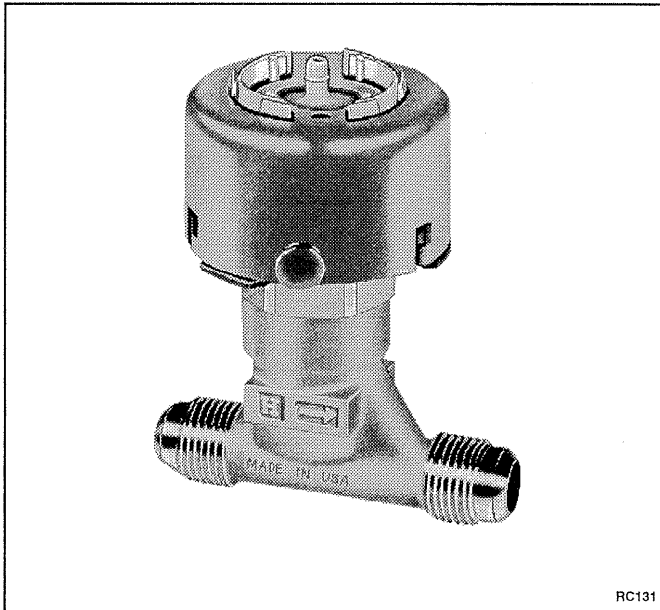

## APPLICATION

The VP527A provides proportional control of hot and/or chilled water flow in unit air conditioners and fan coil units.

## SPECIFICATIONS

### Operating Ranges:

- 2 to 5 psi (15 to 35 kPa)
- 3 to 10 psi (20 to 70 kPa)
- 8 to 11 psi (55 to 75 kPa) (obsolete)

### Maximum Safe Air Pressure:

30 psi (205 kPa)

### Maximum Body Pressure:

250 psi (1720 kPa)

### Controlled Medium Temperature:

35 to 250F (2 to 121C)

### Close-Off Rating:

See Figure 1.

## GENERAL

The VP527A Pneumatic Water Valve (VP527A) is a high pressure water valve, pneumatically operated, single seated, and normally open.

Three design modifications have been made to the valve. Each modification is designated by a Series number (the single-digit number following the basic model number). The Series number is shown only as part of the valve identification.

The production dates of these modifications are:

Series No.	Mfg. Date	Body Configuration
1	1967 and earlier	Straight-through and Angle
2	1968 to 1971	Straight-through and Angle
3	1971 to 1976	Straight-through and Angle
4	1976 to present	Straight-through only

NOTE: Angle pattern bodies are obsolete.



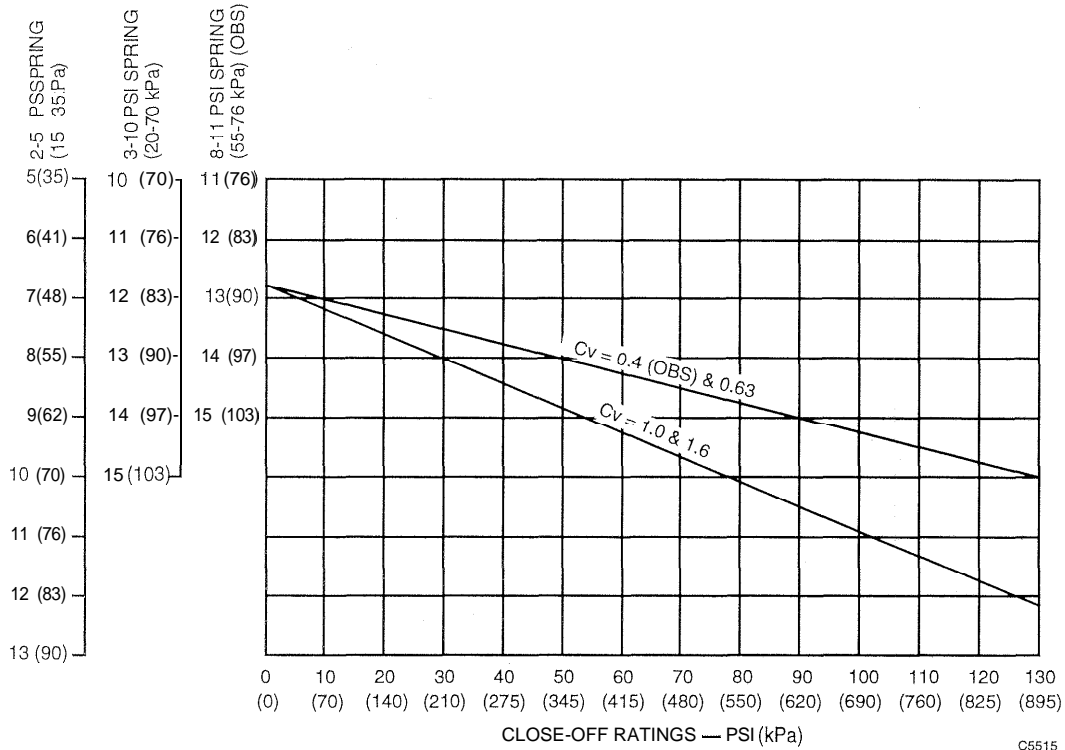

Fig. 1. Close-Off Ratings vs. Control Air Pressure.

## Operation

Figure 2 shows typical VP527A operation. An increase in control air pressure moves the valve stem toward the closed position, decreasing flow through the valve. A decrease in control air pressure moves the valve stem toward the open position, increasing flow through the valve.

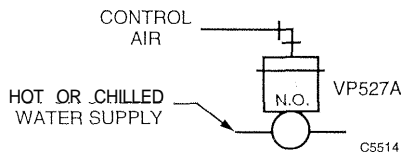

Fig. 2. Typical Operation.

## MAINTENANCE

### General

#### Recommended Tools

1. Pressure bulb assembly consisting of:
  - Pressure bulb, CCT852
  - Tubing CCT853, latex (1 1/32 O.D. x 5/32 I.D.)
2. Add-A-Gage Kit 14003519-001 or a pressure gage assembly consisting of:
  - In-line gage Tee CCT1614B (1/4 in. x 1/4 in. barb x 1/8 FPT)

NOTE: If gage Tee is to be left in the line, use plastic plug CCT1818 to replace gage. If gage Tee is to be removed, use barbed connector CCT1 607B to reconnect tubing.

- Gage 305965, 0 to 30 psi, 1-1/2 in. dia.

#### Recommended Cleaning Solvent

Any common household spray degreasing agent (such as Fantastik).

### Cleaning

Use the cleaning solvent to remove all dirt and grease accumulations from the valve assembly.

### Operational Check

- ① Look for signs of leakage at the stem, bonnet, and connections.
- ② Screw the gage into the in-line gage Tee.
- ③ Cut the branch line near the valve and insert the gage Tee.

- ④ Adjust the thermostat slowly. Verify that valve operation occurs within  $\pm 1$  psi of the rated spring range of the valve.
- ⑤ Verify that valve and the gage operate smoothly. If the gage needle jumps, the valve stem is sticking.

### Heating Application Operation

- ① Set thermostat setpoint below the present room temperature. The discharge air temperature of the coil should drop to the temperature of the air entering the coil with the valve closed.
- ② Raise thermostat setpoint above the present room temperature. The discharge air temperature of the coil should rise as the coil heats up from the hot water flow through the coil with the valve open.

### Cooling Application Operation

- ① Set thermostat setpoint above the present room temperature. The discharge air temperature of the coil should rise to the temperature of the air entering the coil with the valve closed.
- ② Lower thermostat setpoint below the present room temperature. The discharge air temperature of the coil should drop as the coil cools down from the chilled water flow through the coil with the valve open.

# TROUBLESHOOTING

Use the Troubleshooting Flowchart (Fig. 3) to locate problems with the valve.

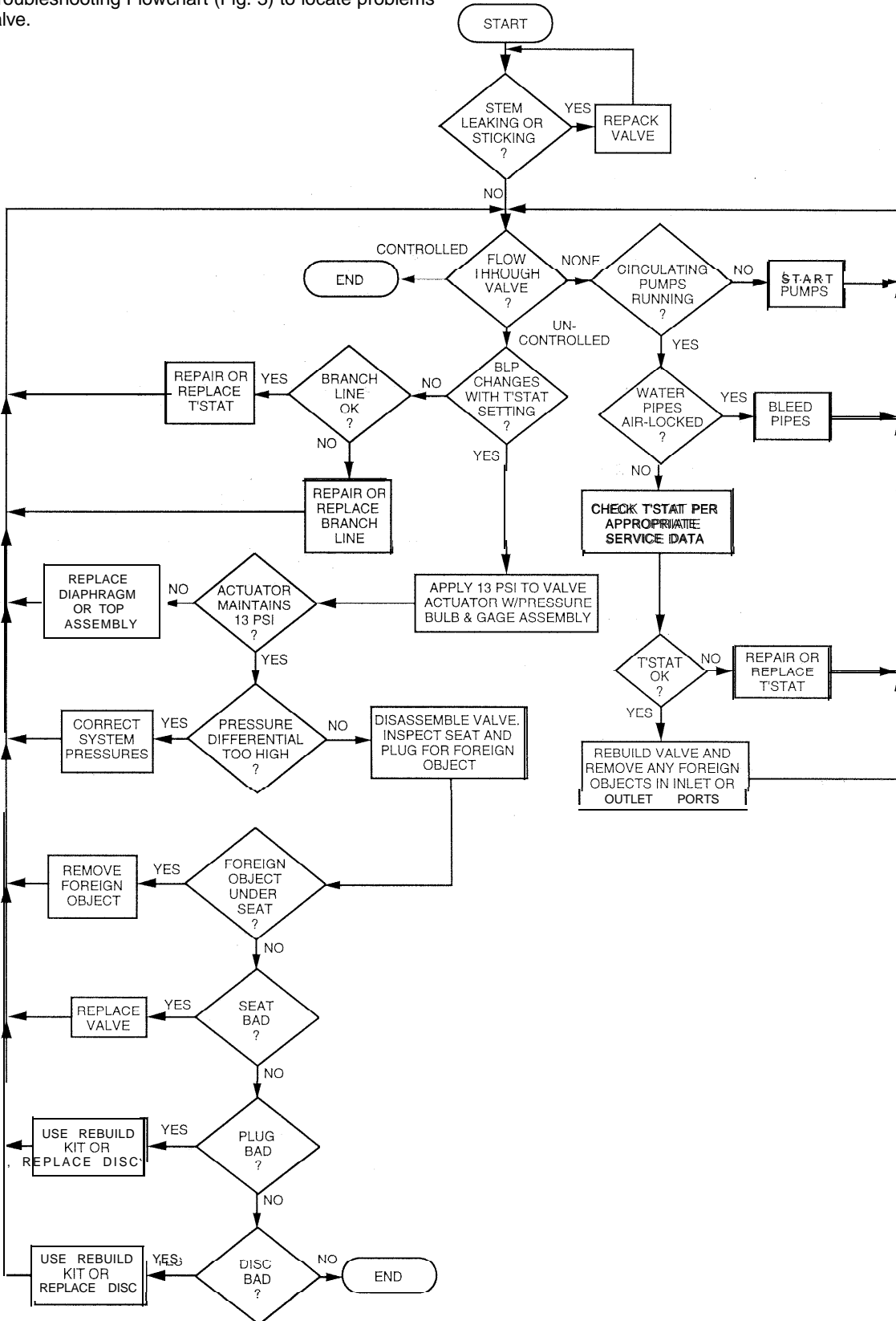

Fig. 3. Troubleshooting.

C5516

## REPAIR

### Recommended Tools and Chemicals

- ❶ 1 -1/4 inch thin open-end wrench, CCT638, for Series 1, 2, and 3 valves.
- ❷ Thermostat Key, 301572A, to remove knurled tamperproof screw (retainer) from cover.
- ❸ Loctite
- ❹ Lubricant, 14002734-002, (Amoco I-I-I 00). Included with repack kit.

### Packing Replacement (14003297-001)

VP527A valves have an O-ring above the disk, which allows repacking the valves without draining the system.

#### Series 1, 2, and 3 Valves

Refer to Figure 4 in PARTS and ACCESSORIES section.

- ❶ Remove air pressure from actuator.
- ❷ Remove retainer from cover.
- ❸ Turn top assembly counterclockwise and lift off.
- ❹ Slide cup to disengage. Remove cup and actuator spring.
- ❺ Unscrew and remove packing nut from bonnet assembly.
- ❻ Remove and discard the packing, spacers, and spring.
- ❼ Use cleaning solvent to clean grease from packing nut, stem, and bonnet assembly.
- ❽ Inspect stem for scored or bent condition. If necessary, replace stem (see STEM AND DISK REPLACEMENT).
- ❾ Use the lubricant supplied in the repack kit when reassembling the spring, packing, and spacers. Make sure that the curved side of the packing is up.
- ❿ Reassemble the valve, restore water and air pressure, and perform operational check.

#### Series 4 Valves

Refer to Figure in PARTS and ACCESSORIES section.

- ❶ Remove air pressure from actuator.
- ❷ Remove retainer from cover.
- ❸ Turn top assembly counterclockwise and lift off.

- ❹ Slide cup to disengage. Remove cup and actuator spring.
- ❺ Unscrew and remove base from bonnet.
- ❻ Remove packing gland from bonnet.
- ❼ Remove and discard the packing, spacers, and spring.
- ❽ Use cleaning solvent to clean grease from packing nut, stem, and bonnet assembly.
- ❾ Inspect stem for scored or bent condition. If necessary, replace stem (see STEM AND DISK REPLACEMENT).
- ❿ Use the lubricant supplied in the repack kit when reassembling the spring, packing, spacers, and packing gland. Make sure that the curved side of the packing is up.
- ⓫ Reassemble the valve, restore water and air pressure, and perform operational check.

### Stem and Disk Replacement

The stem and disk can be replaced as an assembled unit (Stem Assembly 14002560) or the disk can be replaced on the assembly. When changing the stem and disk assembly, it is recommended that the packing also be replaced.

#### Stem Assembly Replacement (140002560)

- ❶ Drain system water to level of valve.
- ❷ Remove air pressure from actuator.
- ❸ Remove retainer from cover.
- ❹ Turn top assembly counterclockwise and lift off.
- ❺ Slide cup to disengage. Remove cup and actuator spring.
- ❻ Unscrew and remove bonnet.
- ❼ Clean stem, then inspect for scores or burrs which could damage packing when stem is pulled through packing. If packing is damaged, replace (see PACKING REPLACEMENT).
- ❽ Remove and discard the stem and disk assembly.
- ❾ Slide new O-ring onto stem.
- ❿ Use new lubricant on stem and insert into bonnet, being careful not to damage the packing.
- ⓫ Reassemble the valve, restore water and air pressure, and perform operational check.

## Disk Replacement

- ① Drain system water to level of valve.
- ② Remove air pressure from actuator.
- ③ Remove retainer from cover.
- ④ Turn top assembly counterclockwise and lift off.
- ⑤ Slide cup to disengage. Remove cup and actuator spring.
- ⑥ Unscrew and remove bonnet.
- ⑦ Clean stem, then inspect for scores or burrs which could damage packing when stem is pulled through packing. If stem is damaged replace stem and packing.
- ⑧ Remove the stem and disk assembly.
- ⑨ Hold stem and disk holder and twist plug to disassemble stem and disk assembly.



### CAUTION

To avoid damage to the stem or plug, do not grip with pliers or in a vice. If the stem or plug is damaged replace the damaged part before reassembling. A damaged plug can damage the seat and a damaged stem can destroy the packing.

- ⑩ Remove the disk and clean the disk holder.
- ⑪ Put new disk on disk holder and replace brass washer.
- ⑫ Place small drop of Loctite on first two threads of disk holder and thread on plug.



### CAUTION

Failure to use Loctite could allow plug to drop off assembly causing loss of control.

- ⑬ Replace O-ring if required.
- ⑭ Use new lubricant on stem and insert into bonnet, being careful not to damage the packing.
- ⑮ Reassemble the valve, restore water and air pressure, and perform operational check.

## Diaphragm Replacement

Repair a leaking diaphragm by replacing the top assembly. The diaphragm on Series 1 and 2 valves can be replaced; however, it is recommended that entire top assembly be replaced. Use either the standard top 14003102 or the vandal-resistant top 14003648.

- ① Disconnect air tubing at the actuator.
- ② Remove retainer. Turn top assembly counterclockwise and lift off.
- ③ Install new top assembly and connect tubing.

## Rebuild Kit Installation

Rebuild Kits 14003475-001 and 14003476-001 replace all parts of the valve except the valve body.

- ① Drain system water to level of valve.
- ② Remove air line from actuator.
- ③ Unscrew bonnet (Series 4) or bonnet assembly (Series 1, 2, and 3) and remove from valve body.
- ④ Inspect valve seat. If valve seat is damaged, replace complete valve.
- ⑤ Install the new assembly.

NOTE: The assembly has a 3 to 10 psi (20 to 70 kPa) operating spring range. If a different operating spring range is required, remove the retainer, actuator assembly, cup, and orange spring. Install the correct spring, green for 2 to 5 psi (15 to 35 kPa) or yellow for 8 to 11 psi (55 to 75 kPa). Reassemble the valve.

- ⑥ Connect air line to actuator. A 1/4-in. compression x 1/4-in. barbed adapter fitting (CCT16355) and a short piece of plastic tubing are included to connect the valve to copper tubing.
- ⑦ Refill the water system and perform operational check.

# PARTS AND ACCESSORIES

## Parts

See Figures 4, 5, and 6 for exploded view diagrams.

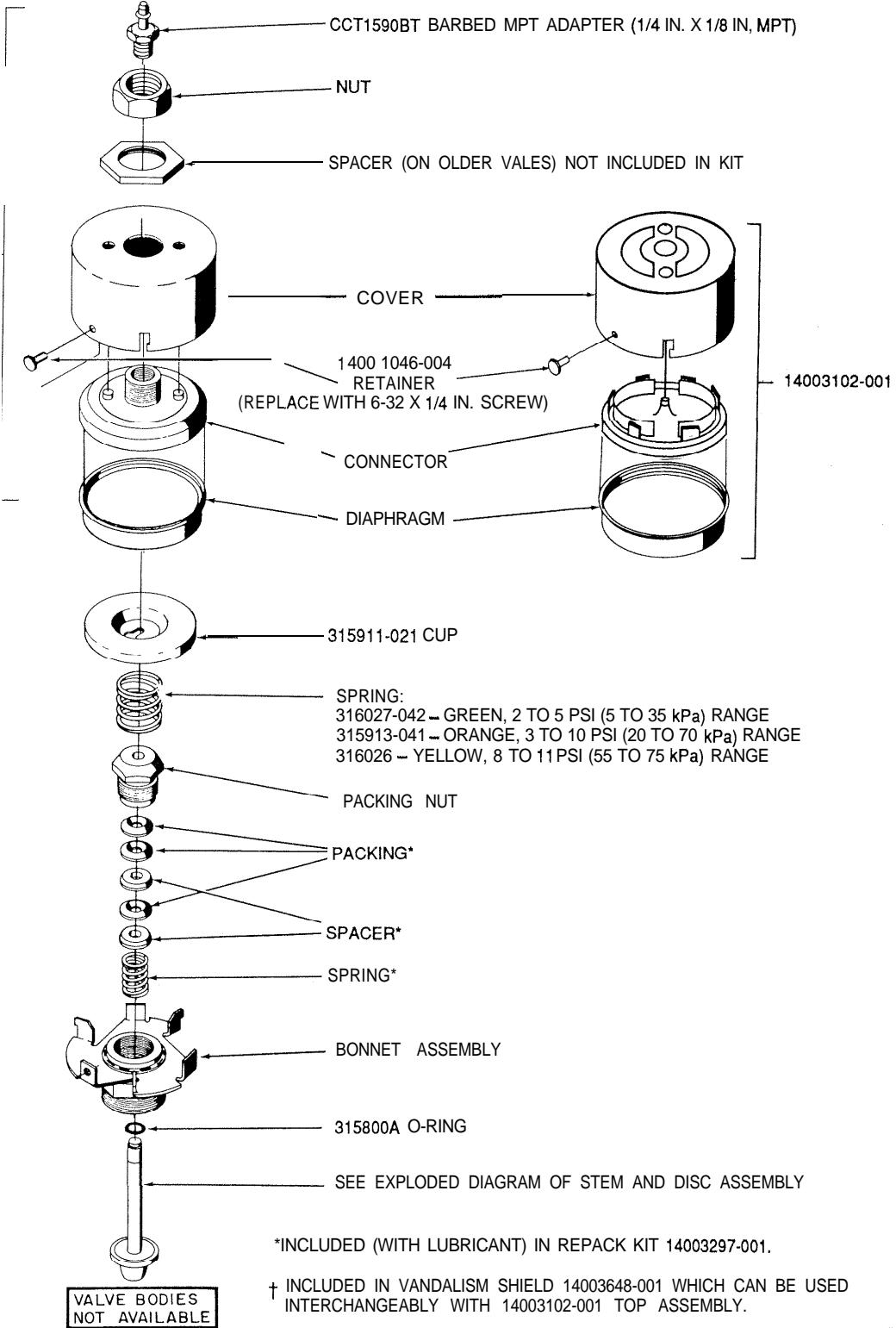
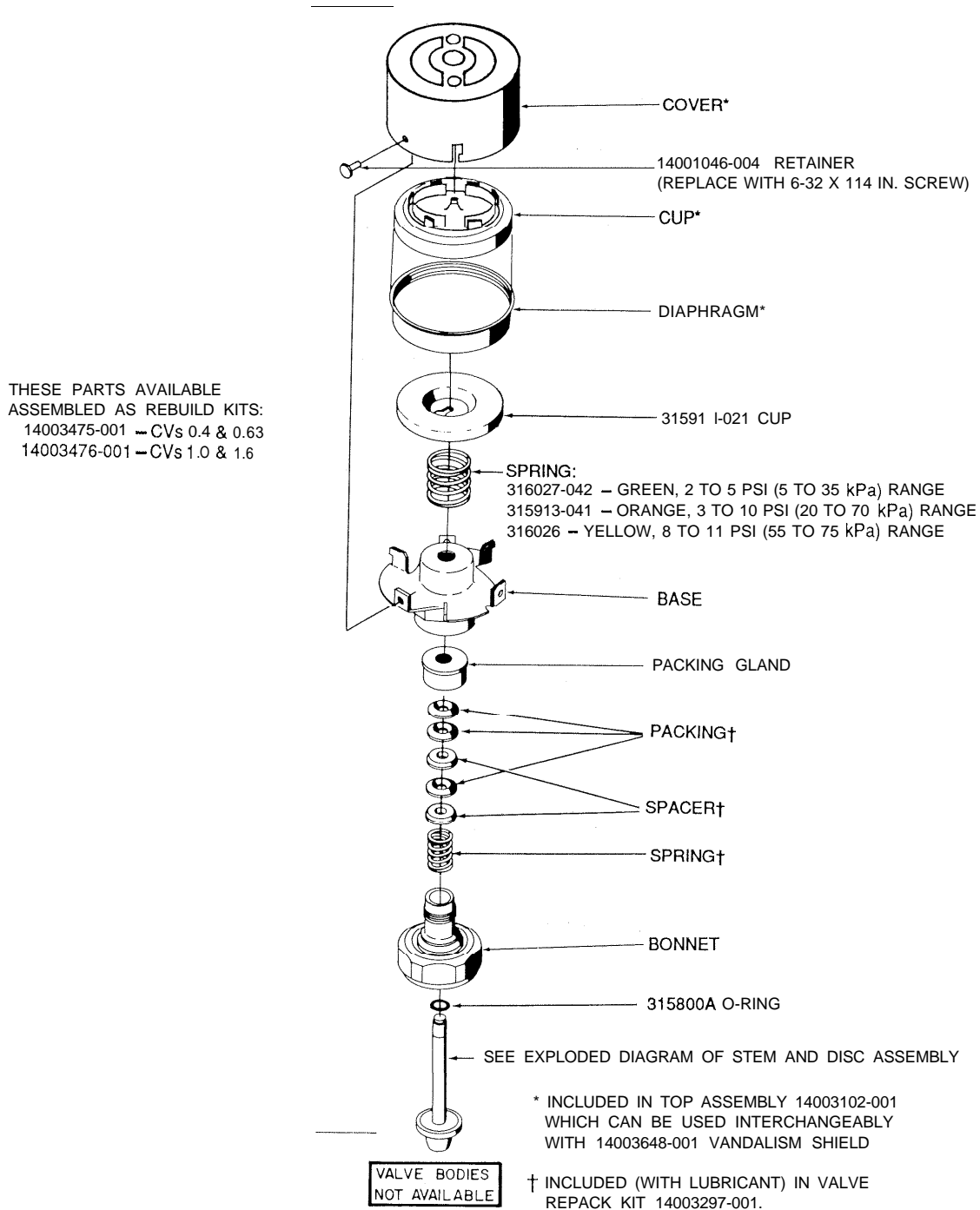

Fig. 4. Exploded Diagram of VP527A Valves, Series 1, 2, and 3.



75-5555-b-2

Fig. 5. Exploded Diagram of VP527A Valves, Series 4.



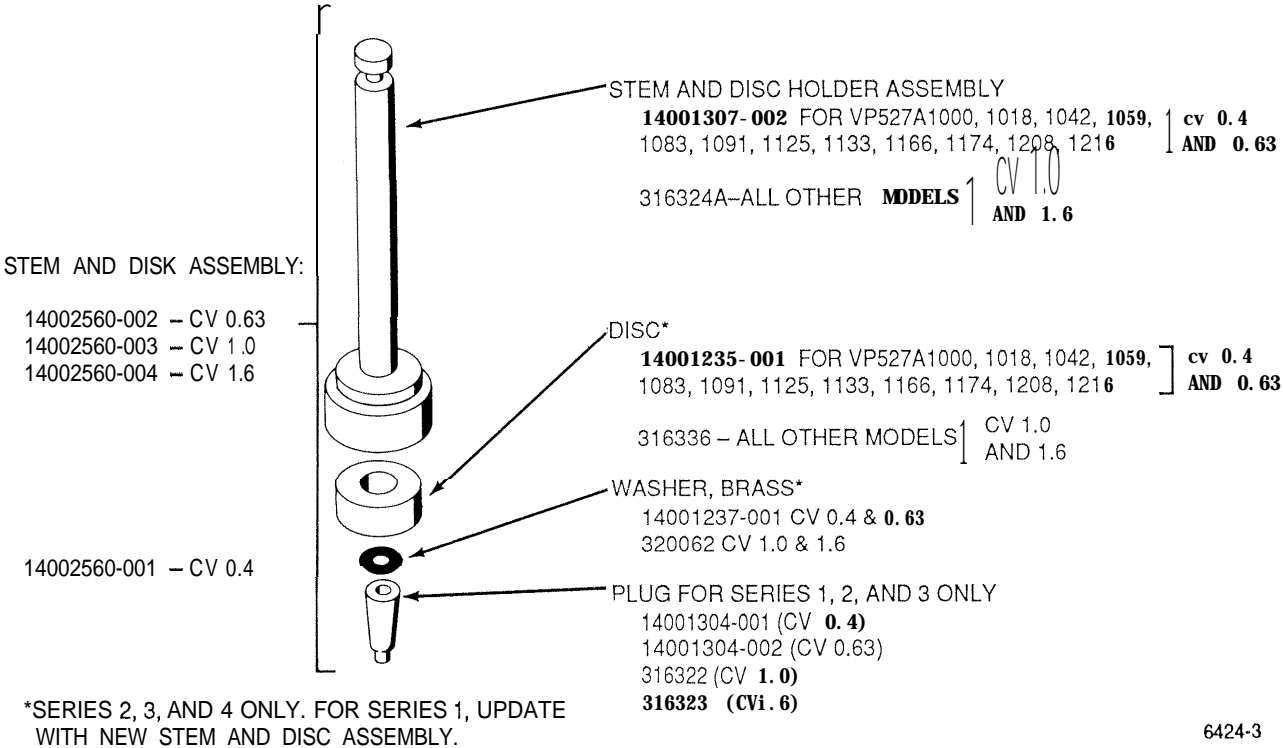

6424-3

Fig. 6. Exploded Diagram of Stem and Disk Assembly.

Accessories

- Position Indicator-I 4001101-001
- Vandalism Shield-I 4003648-001 (Actuator assembly with 1/8 in. FPT connections)

Honeywell

---

Home and Building Control  
Honeywell Inc.  
Honeywell Plaza  
P.O. Box 524  
Minneapolis, MN 55408-0524

Home and Building Control  
Honeywell Limited-Honeywell Limit&  
740 Ellesmere Road  
Scarborough, Ontario  
M1P 2V9

*Helping You Control Your World*