

HERMETIC COMPRESSORS - GENERAL INFORMATION

Information Guide

Unless otherwise noted, capacity ratings for air conditioning applications are:

Evaporator Temp	45° F
Condenser Temp	130° F
Liquid Temp	115° F
Return Gas Temp	65° F
Ambient Temp	95° F

Abbreviations:

CFM	Cubic Feet Per Minute
PWS	Part Wind Starting
SC	Sub-Cooling Temperature
SCT	Saturated Condenser Temperature
SGT	Actual Suction Gas Temperature
SST	Saturated Suction Temperature
XL	Across the Line Start

Mounting Guide

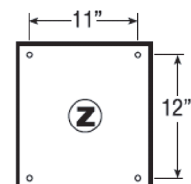
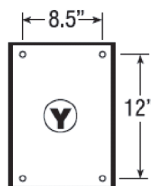
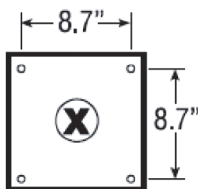
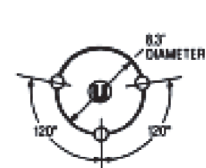
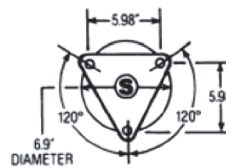
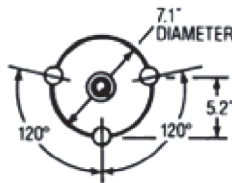
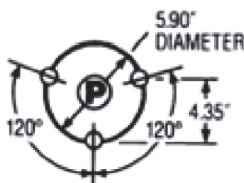
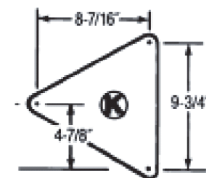
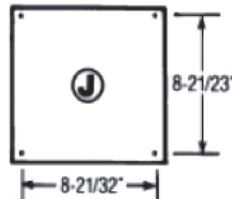
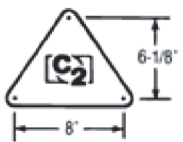
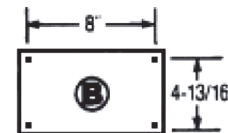
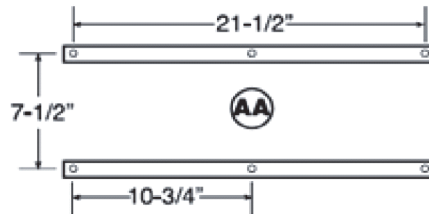
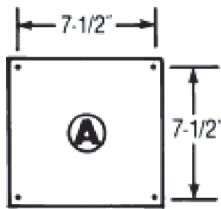

HERMETIC COMPRESSORS - GENERAL INFORMATION

Hermetic Compressors "P-" Part Numbering System

Example: P031-5751 =
 Part Code: Tecumseh
 Capacity: 57,000 nominal btuh/hr
 Voltage: 208/230V 3 phase

P	031	5	7	*(Use for large units)	5	1
Parts	Part Code	Capacity (1000) btuh/hr			Voltage Code	Numerical Sequence

Part Code	Supplier
030	Goldstar
031	Tecumseh
032	Bristol
033	Daewoo
034	Matsushita/Panasonic
035	Toshiba
036	Sanyo
037	Mitsubishi
038	Hitachi
039	Delchi
050	Copeland 50 Hz
051	Tecumseh 50 Hz

Voltage Code	Volts
0	115/1
1	200/1
2	208-230/1
3	230/1
4	200/3
5	208-230/3
6	230/3
7	460/3
8	575/3
9	265/1

HERMETIC COMPRESSORS - BRISTOL RECIPS

Bristol Compressor Part Numbering System

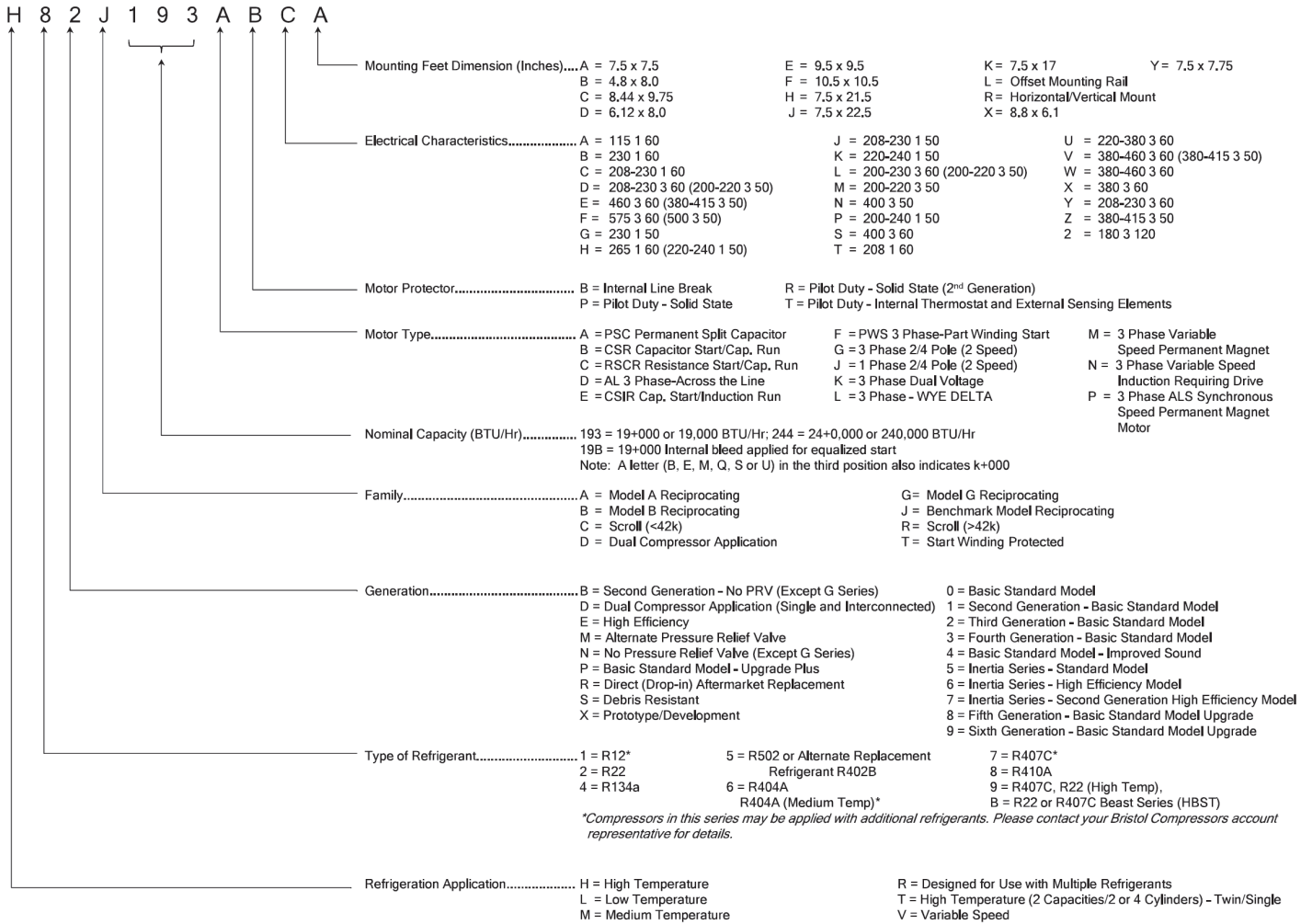

HERMETIC COMPRESSORS - BRISTOL RECIPS

Bristol Hermetic HCRB Recip R-22/R407C

Single Phase 208/230V, 60HZ

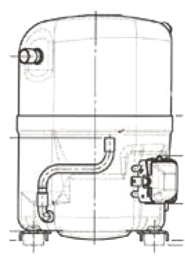

Features:

- Drop-in Replacements for Copeland CR Series
- Low Noise & Vibration levels
- Inherent motor protection
- Improved sound levels
- POE Oil

Part Number	Mfg Number	Refrigerant	MTG ARR	Capacity	Voltage	Phase	Hz	RLA	Height	Run Cap	Suction	Discharge
HCRB183ABCA	HCRB183ABCA	22	7.5 x 7.5	18300	208/230	1	60	7.4	13.5	30/370	3/4 H 11.2	1/2 U 6.3
HCRB223ABCA	HCRB223ABCA	22	7.5 x 7.5	22600	208/230	1	60	9.4	13.5	30/370	3/4 H 11.2	1/2 U 6.3
HCRB243ABCA	HCRB243ABCA	22	7.5 x 7.5	24200	208/230	1	60	9.6	14	35/370	3/4 H 11.2	1/2 U 6.3
HCRB283ABCA	HCRB283ABCA	22	7.5 x 7.5	28800	208/230	1	60	12.1	14	35/370	3/4 H 11.2	1/2 U 6.3
HCRB303ABCA	HCRB303ABCA	22	7.5 x 7.5	29900	208/230	1	60	12	14.5	40/370	3/4 H 12.2	1/2 U 6.3
HCRB353ABCA	HCRB353ABCA	22	7.5 x 7.5	35700	208/230	1	60	15	14.5	45/370	3/4 H 12.2	1/2 U 6.3

Bristol Hermetic Recip R-22

Single Phase 208/230V, 60HZ

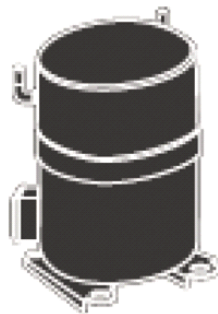

Features:

- For Heat Pump & Air Conditioning duty
- Low Noise & Vibration levels
- Inherent motor protection
- Improved sound levels

Part Number	Mfg Number	Refrigerant	MTG ARR	Capacity	Voltage	Phase	Hz	RLA	Height	Run Cap	Suction	Discharge
P032-1523	H20J153ABCA	22	7.5 x 7.5	15100	208/230	1	60	6.2	13.9	30/370	5/8 U 13.6	3/8 U 4.1
P032-1524	H22J15BABCA	22	7.5 x 7.5	15500	208/230	1	60	6.7	13.5	30/370	3/4 H 11.2	1/2 U 2.9
P032-1820	H22J18BABCA	22	7.5 x 7.5	18300	208/230	1	60	7.4	13.5	30/370	3/4 H 11.2	1/2 U 2.9
P032-2227	T21J225CBCA	22	7.5 x 7.5	22100	208/230	1	60	9.1	15.8	30/440	3/4 U 15.4	1/2 U 4.3
P032-2229	H22J22BABCA	22	7.5 x 7.5	22600	208/230	1	60	9.6	14.0	30/370	3/4 H 11.2	1/2 U 2.9
P032-2429	H22J25BABCA	22	7.5 x 7.5	24200	208/230	1	60	9.6	14.0	35/370	3/4 H 11.7	1/2 U 2.9
P032-2522	T21J265CBCA	22	7.5 x 7.5	25300	208/230	1	60	10.2	15.8	40/440	3/4 U 15.4	1/2 U 4.1
P032-2829	H22J29BABCA	22	7.5 x 7.5	28800	208/230	1	60	11.8	14.0	35/370	3/4 H 11.7	1/2 U 2.9
P032-3121	H22J33BABCA	22	7.5 x 7.5	31900	208/230	1	60	1.0	14.5	40/370	3/4 H 12.2	1/2 U 2.9
P032-3322	T21J334CBCA	22	7.5 x 7.5	33100	208/230	1	60	13.4	15.8	50/440	3/4 U 15.4	1/2 U 4.1
P032-3526	H22J36BABCA	22	7.5 x 7.5	35700	208/230	1	60	14.4	14.5	45/370	3/4 H 12.2	1/2 U 2.9
P032-3721	H22J38BABCA	22	7.5 x 7.5	37800	208/230	1	60	14.9	15.8	45/370	3/4 H 14.0	1/2 U 4.1
P032-4021	H22J41BABCA	22	7.5 x 7.5	40900	208/230	1	60	17.1	15.8	50/370	3/4 H 14.0	1/2 U 4.1
P032-4421	H22J44BABCA	22	7.5 x 7.5	44300	208/230	1	60	17.8	15.8	65/370	3/4 H 14.0	1/2 U 4.1
P032-4922	H22A503ABCA	22	7.5 x 7.5	49000	208/230	1	60	22.3	16.4	40/440	7/8 H 14.0	1/2 U 3.3
P032-5723	H22A583ABCA	22	7.5 x 7.5	57100	208/230	1	60	26.6	16.4	55/440	7/8 H 14.0	1/2 U 3.3
P032-5722	H24A583ABCA	22	7.5 x 7.5	57500	208/230	1	60	25.0	16.1	60/370	7/8 U 15.6	1/2 U 3.3
P032-6022	H22A623ABCA	22	7.5 x 7.5	60800	208/230	1	60	28.2	16.4	55/440	7/8 H 14.0	1/2 U 3.3

HERMETIC COMPRESSORS - BRISTOL RECIPS

Bristol Hermetic Recip R-22

3 Phase 208/230V, 460V, 575V, 60HZ

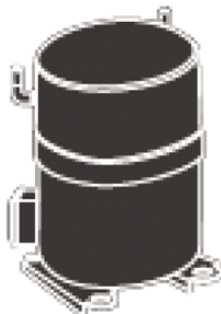

Features:

- For Heat Pump & Air Conditioning duty
- Low Noise & Vibration levels
- Inherent motor protection
- Improved sound levels

Part Number	Mfg Number	Refrigerant	MTG ARR	Capacity	Voltage	Phase	Hz	RLA	Height	Run Cap	Suction	Discharge
P032-2751	H22J293DBLA	22	7.5 x 7.5	28000	208/230	3	60	7.8	14.0	N/A	3/4 H 11.7	1/2 U 2.9
P032-3252	H23A323DBLA	22	7.5 x 7.5	31700	208/230	3	60	9.0	14.6	N/A	3/4 U 14.3	3/8 U 3.3
P032-3255	H22J333DBLA	22	7.5 x 7.5	32400	208/230	3	60	9.0	14.5	N/A	3/4 H 12.2	1/2 U 2.9
P032-3553	H22J363DBLA	22	7.5 x 7.5	35000	208/230	3	60	9.6	14.5	N/A	3/4 H 12.2	1/2 U 2.9
P032-3753	H22J383DBLA	22	7.5 x 7.5	37500	208/230	3	60	10.2	15.8	N/A	3/4 H 14.0	1/2 U 4.1
P032-4051	H22J413DBLA	22	7.5 x 7.5	40500	208/230	3	60	11.0	15.8	N/A	3/4 H 14.0	1/2 U 4.1
P032-4452	H22J443DBDA	22	7.5 x 7.5	44100	208/230	3	60	11.7	15.8	N/A	3/4 H 14.0	1/2 U 4.1
P032-4956	H22A503DBLA	22	7.5 x 7.5	49000	208/230	3	60	13.7	16.4	N/A	7/8 H 14.0	1/2 U 3.3
P032-5352	H22A543DBLA	22	7.5 x 7.5	53400	208/230	3	60	14.5	16.4	N/A	7/8 H 14.0	1/2 U 3.3
P032-5351	H25A54QDBLA	22	7.5 x 7.5	53500	208/230	3	60	14.0	17.4	N/A	3/4 H 15.3	1/2 U 3.8
P032-5854	H22A563DBLA	22	7.5 x 7.5	55600	208/230	3	60	15.3	16.4	N/A	7/8 H 14.0	1/2 U 3.3
P032-6051	H22A623DBLA	22	7.5 x 7.5	60800	208/230	3	60	17.0	16.4	N/A	7/8 H 14.0	1/2 U 3.3
P032-2773	H22J293DBVA	22	7.5 x 7.5	27800	460	3	60	4.1	14.0	N/A	3/4 H 11.7	1/2 U 2.9
P032-3172	H22J333DBVA	22	7.5 x 7.5	31600	460	3	60	4.5	14.5	N/A	3/4 H 12.2	1/2 U 2.9
P032-3171	H23A323DBEA	22	7.5 x 7.5	31700	460	3	60	4.5	14.9	N/A	5/8 H 12.5	3/8 U 3.3
P032-3475	H22J363DBVA	22	7.5 x 7.5	34400	460	3	60	4.9	14.5	N/A	3/4 H 12.2	1/2 U 2.9
P032-3773	H22J383DBVA	22	7.5 x 7.5	37500	460	3	60	5.0	15.8	N/A	3/4 H 14.0	1/2 U 4.1
P032-4172	H22J413DBEA	22	7.5 x 7.5	40400	460	3	60	5.4	15.8	N/A	3/4 H 14.0	1/2 U 4.1
P032-4471	H22J443DBEA	22	7.5 x 7.5	44100	460	3	60	5.8	15.8	N/A	3/4 H 14.0	1/2 U 4.1
P032-4975	H22A503DBEA	22	7.5 x 7.5	49000	460	3	60	6.8	16.4	N/A	7/8 H 14.0	1/2 U 3.3
P032-5871	H22A583DBEA	22	7.5 x 7.5	58400	460	3	60	7.9	16.4	N/A	7/8 H 14.0	1/2 U 3.3
P032-5872	H22A623DBEA	22	7.5 x 7.5	60800	460	3	60	8.5	16.4	N/A	7/8 H 14.0	1/2 U 3.3
P032-4481	H22J443DBFA	22	7.5 x 7.5	44100	575	3	60	4.6	15.8	N/A	3/4 H 14.0	1/2 U 4.1
P032-4982	H25A50QDBFA	22	7.5 x 7.5	49000	575	3	60	5.2	17.4	N/A	7/8 H 15.3	1/2 U 3.8
P032-5883	H22A563DBFA	22	7.5 x 7.5	55600	575	3	60	6.4	16.4	N/A	7/8 H 14.0	1/2 U 3.3

HERMETIC COMPRESSORS - BRISTOL RECIPS

Bristol Hermetic Recip R410A

Single Phase 208/230V, 60HZ

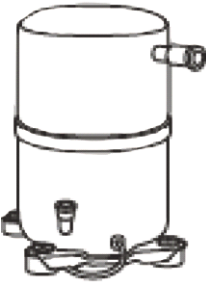

Features:

- For Heat Pump & Air Conditioning duty
- Low Noise & Vibration levels
- Inherent motor protection
- Improved sound levels

Part Number	Mfg Number	Refrigerant	MTG ARR	Capacity	Voltage	Phase	Hz	RLA	Height	Run Cap	Suction	Discharge
P032-1423	H82J153ABCA	410A	7.5 x 7.5	14700	208/230	1	60	6.5	14.3	30/370	3/4 H 11.7	1/2 U 2.9
P032-18211	H82J183ABCA	410A	7.5 x 7.5	18100	208/230	1	60	7.4	14.5	35/370	3/4 H 11.7	1/2 U 2.9
P032-1829K	T81J195CBCA	410A	7.5 x 7.5	18300	208/230	1	60	11.4	15.6	30/440	3/4 U 15.2	1/2 U 4.2
P032-1926K	T89B194CBCA	410A	7.5 x 7.5	19250	208/230	1	60	11.9	14.3	25/440	3/4 H 12.1	1/2 U 3.0
P032-22210	H82J223ABCA	410A	7.5 x 7.5	22300	208/230	1	60	9.9	15.0	35/370	3/4 H 12.2	1/2 U 2.9
P032-2725	H82J273ABCA	410A	7.5 x 7.5	27100	208/230	1	60	11.8	15.0	40/370	3/4 H 12.2	1/2 U 2.9
P032-2722K	T89B284CBCA	410A	7.5 x 7.5	27200	208/230	1	60	15.0	14.3	45/440	3/4 H 12.1	1/2 U 3.0
P032-2723K	T81J285CBCA	410A	7.5 x 7.5	27700	208/230	1	60	14.3	15.6	40/440	3/4 U 15.2	1/2 U 4.2
P032-3026	H82J303ABCA	410A	7.5 x 7.5	30800	208/230	1	60	13.0	15.0	45/370	3/4 U 12.5	1/2 U 2.9
P032-3226	H82J323ABCA	410A	7.5 x 7.5	32200	208/230	1	60	13.6	15.3	45/370	3/4 H 12.5	1/2 U 2.9
P032-3525K	T81J384CBCA	410A	7.5 x 7.5	35500	208/230	1	60	25.0	15.6	55/440	3/4 U 15.2	1/2 U 4.2
P032-3722K	T89B385CBCA	410A	7.5 x 7.5	37600	208/230	1	60	22.0	14.3	55/440	3/4 H 12.1	1/2 U 3.0
P032-5121K	T89A514BBCA	410A	7.5 x 7.5	51470	208/230	1	60	28.6	17.4	55/370	7/8 H 15.3	1/2 U 3.3
P032-5122K	T89A514BBCA	410A	7.5 x 7.5	51900	208/230	1	60	29.3	17.4	55/370	7/8 U 17.0	1/2 U 3.3
P032-5221K	T89A515BBCA	410A	7.5 x 7.5	52700	208/230	1	60	28.2	17.4	55/370	7/8 U 16.8	1/2 U 3.8

HERMETIC COMPRESSORS - COPELAND RECIPS

Recip Part Numbering System

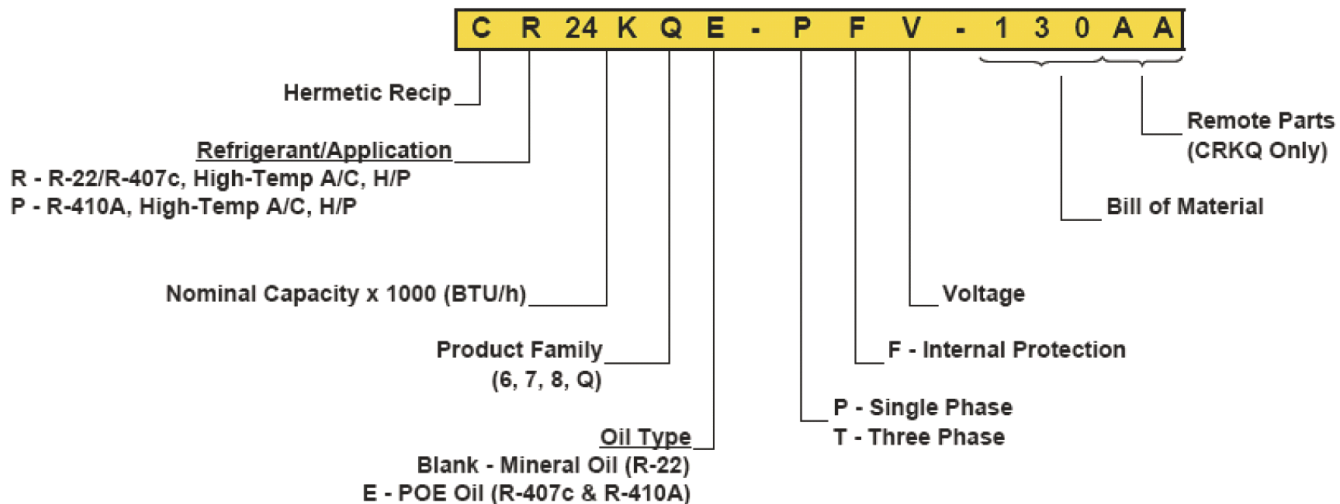

HERMETIC COMPRESSORS - COPELAND RECIPS

Hermetic Recip R-22/407C

Single Phase 208/230V, 265V, 60HZ

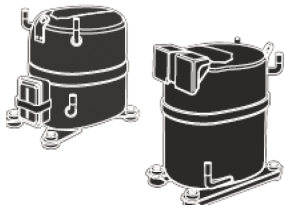

Features:

- For Heat Pump & Air Conditioning duty
- Low Noise & Vibration levels
- POE Oil

Part Number	Refrigerant	MTG ARR	Capacity	Voltage	Phase	Hz	RLA	Height	Run Cap	Suction	Discharge
CR18K6E-PFV-775	22	7.5 x 7.5	18000	208/230	1	60	10.4	13.2	25/370	3/4 H 10.95	1/2 U 5.86
CR20K6E-PFV-775	22	7.5 x 7.5	19600	208/230	1	60	10.6	13.2	30/370	3/4 H 10.95	1/2 U 5.86
CR22K6E-PFV-775	22	7.5 x 7.5	22100	208/230	1	60	10.9	13.2	30/370	3/4 H 10.95	1/2 U 5.86
CR24K6E-PFV-775	22	7.5 x 7.5	24500	208/230	1	60	12.4	13.4	35/370	3/4 H 11.20	1/2 U 5.86
CR28K6E-PFV-775	22	7.5 x 7.5	28200	208/230	1	60	15.3	13.2	35/370	3/4 H 11.32	1/2 U 5.86
CR34K6E-PFV-775	22	7.5 x 7.5	34500	208/230	1	60	16.6	14.1	50/370	3/4 H 11.82	1/2 U 5.86
CR42K6E-PFV-775	22	7.5 x 7.5	41900	208/230	1	60	20.4	14.6	40/370	3/4 H 12.32	1/2 U 5.86
CR47KQE-PFV-970	22	7.5 x 7.5	47500	208/230	1	60	24.6	14.8	45/440	7/8 U 14.41	1/2 U 5.86
CR53KQE-PFV-970	22	7.5 x 7.5	53300	208/230	1	60	28.9	14.8	60/440	7/8 U 14.41	1/2 U 5.86
CRPQ-045E-PFV-970	22	7.5 x 7.5	58400	208/230	1	60	30.7	16.1	45/440	7/8 U 15.29	1/2 U 2.78
CRNQ-050E-PFV-970	22	7.5 x 7.5	60600	208/230	1	60	34.3	16.1	55/440	7/8 U 15.29	1/2 U 2.78
CR16K6E-PFJ-775	22	7.5 x 7.5	16300	265	1	60	9.0	13.2	25/370	3/4 Stub	1/2 Stub
CR22K6E-PFJ-775	22	7.5 x 7.5	22100	265	1	60	9.9	13.3	30/440	3/4 Stub	1/2 Stub
CR24K6E-PFJ-775	22	7.5 x 7.5	24500	265	1	60	10.9	13.4	35/440	3/4 Stub	1/2 Stub
CR32K6E-PFJ-775	22	7.5 x 7.5	32000	265	1	60	15.0	13.8	35/440	3/4 Stub	1/2 Stub

3 Phase 208/230V, 460V, 575V, 60HZ

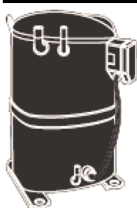

Features:

- External Line Break Overload
- Low Noise & Vibration levels
- Lightweight
- POE Oil

Part Number	Refrigerant	MTG ARR	Capacity	Voltage	Phase	Hz	RLA	Height	Run Cap	Suction	Discharge
CR18K6E-TF5-775	22	7.5 x 7.5	17600	208/230	3	60	6.1	13.2	N/A	3/4 H 11.07	1/2 U 5.86
CR24K6E-TF5-775	22	7.5 x 7.5	24000	208/230	3	60	7.7	13.4	N/A	3/4 H 11.2	1/2 U 5.86
CR35K6E-TF5-775	22	7.5 x 7.5	34900	208/230	3	60	11.4	14.1	N/A	3/4 H 11.82	1/2 U 5.86
CR42K6E-TF5-775	22	7.5 x 7.5	41700	208/230	3	60	14.0	14.6	N/A	3/4 H 12.32	1/2 U 5.86
CR47KQE-TF5-970	22	7.5 x 7.5	47200	208/230	3	60	16.1	14.8	N/A	7/8 U 14.30	1/2 U 5.86
CR53KQE-TF5-970	22	7.5 x 7.5	53200	208/230	3	60	18.2	14.8	N/A	7/8 H 13.06	1/2 U 6.25
CRPQ-045E-TF5-970	22	7.5 x 7.5	57000	208/230	3	60	19.6	16.1	N/A	7/8 U 15.29	1/2 U 2.78
CRNQ-050E-TF5-970	22	7.5 x 7.5	61500	208/230	3	60	21.4	16.1	N/A	7/8 U 15.29	1/2 U 2.78
CR24K6E-TFD-775	22	7.5 x 7.5	24000	460	3	60	4.0	13.4	N/A	3/4 H 11.20	1/2 U 5.86
CR35K6E-TFD-775	22	7.5 x 7.5	34900	460	3	60	4.8	14.1	N/A	3/4 H 11.82	1/2 U 5.86
CR42K6E-TFD-775	22	7.5 x 7.5	41700	460	3	60	6.4	14.6	N/A	3/4 H 12.32	1/2 U 5.86
CR47KQE-TFD-970	22	7.5 x 7.5	47200	460	3	60	8.2	14.8	N/A	7/8 U 14.30	1/2 U 5.86
CR53KQE-TFD-970	22	7.5 x 7.5	48800	460	3	60	9.1	14.8	N/A	7/8 H 13.06	1/2 U 6.25
CRPQ-045E-TFD-970	22	7.5 x 7.5	57000	460	3	60	10.4	15.9	N/A	7/8 U 15.29	1/2 U 2.78
CRNQ-050E-TFD-970	22	7.5 x 7.5	61500	460	3	60	9.6	16.1	N/A	7/8 U 15.29	1/2 U 2.78
CR35K6E-TFE-775	22	7.5 x 7.5	34900	575	3	60	4.1	14.1	N/A	3/4 H 11.82	1/2 U 5.86

HERMETIC COMPRESSORS - COPELAND SCROLLS

Scroll Part Numbering System

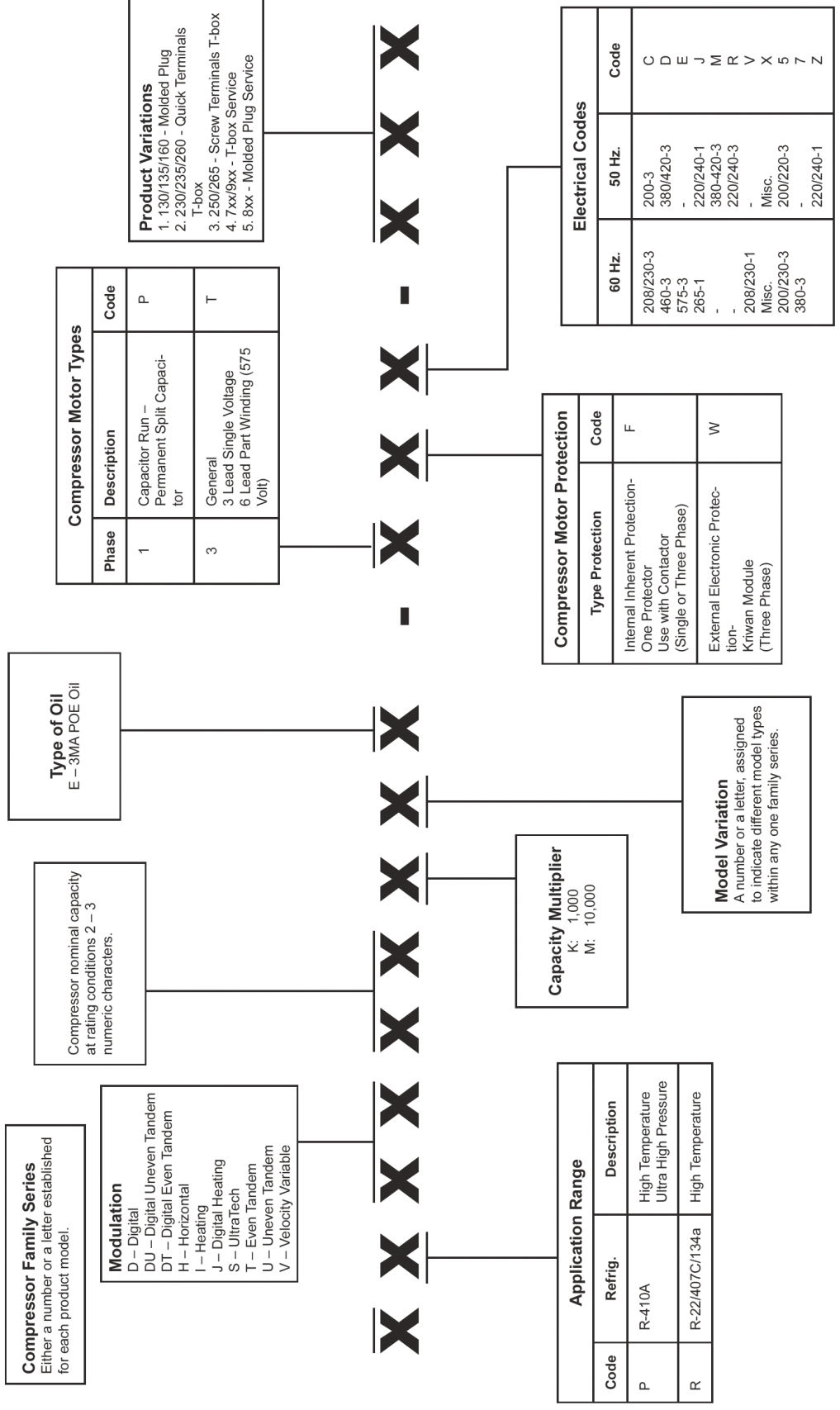

HERMETIC COMPRESSORS - COPELAND SCROLLS

Hermetic Scrolls R-22/R407C

Single Phase 208/230V, 265V, 60HZ

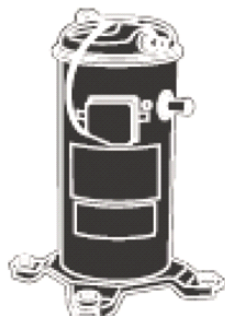

Features:

- ZR'S for high efficiency – EER 11.0 plus
- Low Noise & Vibration levels
- Inherent motor protection
- Centrifugal oil pump
- For Heat Pump & Air Conditioning duty
- POE Oil

Part Number	Refrigerant	MTG ARR	Capacity	Voltage	Phase	Hz	RLA	Height	Run Cap	Suction	Discharge
ZR16K5E-PFV-830	22	7.5 x 7.5	15500	208/230	1	60	9.3	15.9	30/370	3/4 H 10.1	1/2 H 14.2
ZR18K5E-PFV-830	22	7.5 x 7.5	18000	208/230	1	60	10.7	15.9	30/370	3/4 H 10.1	1/2 H 14.2
ZR21K5E-PFV-830	22	7.5 x 7.5	21000	208/230	1	60	12.0	15.9	35/370	3/4 H 10.1	1/2 H 14.2
ZR25K5E-PFV-830	22	7.5 x 7.5	25300	208/230	1	60	15.0	15.9	40/370	3/4 H 10.1	1/2 H 14.2
ZR28K5E-PFV-830	22	7.5 x 7.5	28400	208/230	1	60	15.7	15.9	45/370	3/4 H 10.1	1/2 H 14.2
ZR32K5E-PFV-830	22	7.5 x 7.5	32600	208/230	1	60	17.1	15.9	50/370	3/4 H 10.1	1/2 H 14.2
ZR38K5E-PFV-830	22	7.5 x 7.5	38000	208/230	1	60	21.4	16.9	55/370	7/8 H 11.1	1/2 H 15.4
ZR42K5E-PFV-830	22	7.5 x 7.5	42200	208/230	1	60	22.1	16.3	55/370	7/8 H 11.1	1/2 H 15.4
ZR44K5E-PFV-830	22	7.5 x 7.5	44000	208/230	1	60	22.5	16.9	60/370	7/8 H 11.1	1/2 H 15.4
ZR48K5E-PFV-830	22	7.5 x 7.5	48200	208/230	1	60	24.3	16.9	60/440	7/8 H 11.1	1/2 H 15.4
ZR54K5E-PFV-830	22	7.5 x 7.5	53500	208/230	1	60	28.2	16.9	80/370	7/8 H 11.1	1/2 H 15.4
ZR57K3E-PFV-830	22	7.5 x 7.5	58000	208/230	1	60	32.1	17.8	80/370	7/8 H 11.68	1/2 H 16.13
ZR61K3E-PFV-830	22	7.5 x 7.5	62000	208/230	1	60	32.1	17.8	80/370	7/8 H 11.68	1/2 H 16.13
ZR61K3E-PFV-950	22	7.5 x 7.5	62000	208/230	1	60	32.1	17.8	80/370	7/8 H 11.68	1/2 H 16.13
ZR68KCE-PFV-950	22	7.5 x 7.5	69500	208/230	1	60	32.1	17.8	80/440	7/8 H 11.68	1/2 H 16.13
ZR42K5E-PFJ-830	22	7.5 x 7.5	42200	265	1	60	19.3	19.9	60/440	7/8 Stub	1/2 Stub

Hermetic Compressors

HERMETIC COMPRESSORS - COPELAND SCROLLS

Hermetic Scrolls R-22/R407C

3 Phase 208/230V, 460V, 575V, 60HZ

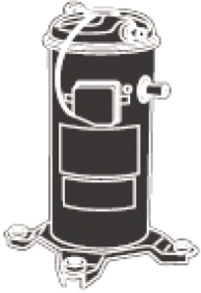

Features:

- ZR'S for high efficiency – EER 11.0 plus
- Low Noise & Vibration levels
- Inherent motor protection
- Centrifugal oil pump
- For Heat Pump & Air Conditioning duty
- POE Oil

Part Number	Refrigerant	MTG ARR	Capacity	Voltage	Phase	Hz	RLA	Height	Run Cap	Suction	Discharge
ZR28K5E-TF5-830	22	7.5 x 7.5	28400	208/230	3	60	11.1	15.9	N/A	3/4 H 10.1	1/2 H 14.2
ZR32K5E-TF5-830	22	7.5 x 7.5	32600	208/230	3	60	12.0	15.9	N/A	3/4 H 10.1	1/2 H 14.2
ZR38K5E-TF5-830	22	7.5 x 7.5	38000	208/230	3	60	13.6	16.9	N/A	7/8 H 11.1	1/2 H 15.4
ZR42K5E-TF5-830	22	7.5 x 7.5	42200	208/230	3	60	14.3	16.3	N/A	7/8 H 11.1	1/2 H 15.4
ZR44K5E-TF5-830	22	7.5 x 7.5	44000	208/230	3	60	14.3	16.9	N/A	7/8 H 11.1	1/2 H 15.4
ZR48K5E-TF5-830	22	7.5 x 7.5	48200	208/230	3	60	17.1	16.9	N/A	7/8 H 11.1	1/2 H 15.4
ZR54K5E-TF5-830	22	7.5 x 7.5	53500	208/230	3	60	17.1	16.9	N/A	7/8 H 11.1	1/2 H 15.4
ZR57K3E-TF5-830	22	7.5 x 7.5	58500	208/230	3	60	19.3	17.2	N/A	7/8 H 11.68	1/2 H 16.13
ZR57K3E-TF5-950	22	7.5 x 7.5	58500	208/230	3	60	19.3	17.2	N/A	7/8 H 11.68	1/2 H 16.13
ZR61K3E-TF5-830	22	7.5 x 7.5	62000	208/230	3	60	19.3	17.2	N/A	7/8 H 11.68	1/2 H 16.13
ZR68KCE-TF5-950	22	7.5 x 7.5	70000	208/230	3	60	20.7	17.8	N/A	7/8 Stub	1/2 Stub
ZR72KCE-TF5-830	22	7.5 x 7.5	73500	208/230	3	60	20.7	17.2	N/A	7/8 H 11.68	1/2 H 16.13
ZR72KCE-TF5-950	22	7.5 x 7.5	73500	208/230	3	60	20.7	17.8	N/A	7/8 Stub	1/2 Stub
ZR81KCE-TF5-965	22	7.5 x 7.5	82000	208/230	3	60	25.0	18.0	N/A	1-1/4 Rotalock	1 1/4 Rotalock
ZR84KCE-TF5-950	22	7.5 x 7.5	85500	208/230	3	60	28.6	18.8	N/A	1-1/8 Stub	7/8 Stub
ZR90K3E-TWC-922	22	7.5 x 7.5	89000	208/230	3	60	29.3	21.2	N/A	1-3/8 Stub	7/8 Stub
ZR90K3E-TWC-961	22	7.5 x 7.5	89000	208/230	3	60	29.3	21.2	N/A	1-3/8 Stub	7/8 Stub
ZR94KCE-TF5-950	22	7.5 x 7.5	96500	208/230	3	60	32.1	18.8	N/A	1-1/8 Stub	7/8 Stub
ZR108KCE-TF5-950	22	7.5 x 7.5	109000	208/230	3	60	33.6	21.0	N/A	1-3/8 H 4.81	7/8 H 19.73
ZR125KCE-TF5-950	22	7.5 x 7.5	128000	208/230	3	60	41.4	21.0	N/A	1-3/8 H 4.81	7/8 H 19.73
ZR144KCE-TF5-950	22	7.5 x 7.5	146000	208/230	3	60	47.1	21.0	N/A	1-3/8 H 4.81	7/8 H 19.73
ZR16M3E-TWC-922	22	8.7 x 8.7	154000	208/230	3	60	48.9	21.5	N/A	1-3/8 Stub	7/8 Stub
ZR16M3E-TWC-961	22	8.7 x 8.7	154000	208/230	3	60	48.9	21.5	N/A	1-3/4 Rotalock	1 1/4 Rotalock
ZR190KCE-TE5-950	22	7.5 x 7.5	181000	208/230	3	60	60.0	21.7	N/A	1-3/8 H 5.53	7/8 H 20.46
ZR19M3E-TWC-961	22	8.7 x 8.7	185000	208/230	3	60	55.0	23.3	N/A	2-1/4 Rotalock	1 1/4 Rotalock
ZR32K5E-TFD-830	22	7.5 x 7.5	32600	460	3	60	6.4	15.9	N/A	3/4 H 10.1	1/2 H 14.2
ZR38K5E-TFD-830	22	7.5 x 7.5	38000	460	3	60	6.4	16.9	N/A	7/8 H 11.1	1/2 H 15.4
ZR42K5E-TFD-830	22	7.5 x 7.5	42200	460	3	60	6.4	16.3	N/A	7/8 H 11.1	1/2 H 15.4
ZR44K5E-TFD-830	22	7.5 x 7.5	44000	460	3	60	6.8	16.9	N/A	7/8 H 11.1	1/2 H 15.4
ZR48K5E-TFD-830	22	7.5 x 7.5	48200	460	3	60	7.9	16.9	N/A	7/8 H 11.1	1/2 H 15.4
ZR54K5E-TFD-830	22	7.5 x 7.5	53500	460	3	60	7.9	16.9	N/A	7/8 H 11.1	1/2 H 15.4
ZR57K3E-TFD-930	22	7.5 x 7.5	55000	460	3	60	9.1	17.2	N/A	7/8 H 11.68	1/2 H 16.13
ZR57K3E-TFD-830	22	7.5 x 7.5	58500	460	3	60	9.1	17.2	N/A	7/8 H 11.68	1/2 H 16.13
ZR57K3E-TFD-950	22	7.5 x 7.5	58500	460	3	60	9.1	17.2	N/A	7/8 H 11.68	1/2 H 16.13
ZR61K3E-TFD-830	22	7.5 x 7.5	62000	460	3	60	9.1	17.2	N/A	7/8 H 11.68	1/2 H 16.13
ZR68KCE-TFD-950	22	7.5 x 7.5	70000	460	3	60	10.0	17.8	N/A	7/8 Stub	1/2 Stub
ZR72KCE-TFD-830	22	7.5 x 7.5	73500	460	3	60	10.0	17.2	N/A	7/8 H 11.68	1/2 H 16.13
ZR72KCE-TFD-950	22	7.5 x 7.5	73500	460	3	60	10.0	17.2	N/A	7/8 H 11.68	1/2 H 16.13
ZR81KCE-TFD-950	22	7.5 x 7.5	82000	460	3	60	12.1	18.0	N/A	7/8 Stub	3/4 Stub
ZR84KCE-TFD-950	22	7.5 x 7.5	85500	460	3	60	14.3	18.8	N/A	1-1/8 Stub	7/8 Stub

HERMETIC COMPRESSORS - COPELAND SCROLLS

Hermetic Scrolls R-22/R407C

3 Phase 208/230V, 460V, 575V, 60HZ

Part Number	Refrigerant	MTG ARR	Capacity	Voltage	Phase	Hz	RLA	Height	Run Cap	Suction	Discharge
ZR90K3E-TWD-961	22	7.5 x 7.5	89000	460	3	60	14.1	21.2	N/A	1-3/8 Stub	7/8 Stub
ZR94KCE-TFD-950	22	7.5 x 7.5	94000	460	3	60	16.4	18.8	N/A	1-1/8 Stub	7/8 Stub
ZR11M3E-TWD-922	22	7.5 x 7.5	108000	460	3	60	17.0	21.2	N/A	1-3/8 Stub	7/8 Stub
ZR108KCE-TFD-950	22	7.5 x 7.5	109000	460	3	60	17.3	21.0	N/A	1-3/8 H 4.81	7/8 H 19.73
ZR125KCE-TFD-950	22	7.5 x 7.5	125000	460	3	60	19.2	21.0	N/A	1-3/8 H 4.81	7/8 H 19.73
ZR12M3E-TWD-922	22	7.5 x 7.5	125000	460	3	60	18.4	21.2	N/A	1-3/8 Stub	7/8 Stub
ZR12M3E-TWD-961	22	7.5 x 7.5	125000	460	3	60	18.4	21.2	N/A	1-3/8 Stub	7/8 Stub
ZR144KCE-TFD-950	22	7.5 x 7.5	146000	460	3	60	20.7	21.0	N/A	1-3/8 H 4.81	7/8 H 19.73
ZR16M3E-TWD-922	22	8.7 x 8.7	154000	460	3	60	27.2	21.5	N/A	1-3/8 Stub	7/8 Stub
ZR16M3E-TWD-961	22	8.7 x 8.7	154000	460	3	60	27.2	21.5	N/A	1-3/4 Rotalock	1 1/4 Rotalock
ZR19M3E-TWD-922	22	8.7 x 8.7	185000	460	3	60	32.1	23.3	N/A	1-3/8 Stub	7/8 Stub
ZR19M3E-TWD-961	22	8.7 x 8.7	185000	460	3	60	32.1	23.3	N/A	2-1/4 Rotalock	1 1/4 Rotalock
ZR250KCE-TED-965	22	10.5 x 10.5	250000	460	3	60	33.6	28.6	N/A	1-5/8 H 13.13	1 3/8 H 26.26
ZR250KCE-TWD-965	22	10.5 x 10.5	250000	460	3	60	33.6	28.6	N/A	2-1/4 Rotalock	1 1/4 Rotalock
ZR44K5E-TFE-830	22	7.5 x 7.5	44000	575	3	60	5.0	16.9	N/A	7/8 H 11.1	1/2 H 15.4
ZR57K3E-TFE-950	22	7.5 x 7.5	58500	575	3	60	7.9	17.2	N/A	7/8 H 11.1	1/2 H 16.3
ZR61K3E-TFE-930	22	7.5 x 7.5	62000	575	3	60	7.9	17.2	N/A	7/8 H 11.68	1/2 H 16.13
ZR72KCE-TFE-950	22	7.5 x 7.5	73500	575	3	60	8.2	17.8	N/A	7/8 Stub	1/2 Stub
ZR94KCE-TFE-950	22	7.5 x 7.5	96500	575	3	60	12.0	18.8	N/A	1-1/8 Stub	7/8 Stub
ZR108KCE-TFE-950	22	7.5 x 7.5	109000	575	3	60	13.5	21.0	N/A	1-3/8 H 4.81	7/8 H 19.73
ZR125KCE-TFE-950	22	7.5 x 7.5	127000	575	3	60	13.8	21.0	N/A	1-3/8 H 4.81	7/8 H 19.73
ZR16M3E-TWE-922	22	8.7 x 8.7	154000	575	3	60	19.3	21.5	N/A	1-3/8 Stub	7/8 Stub
ZR16M3E-TWE-961	22	8.7 x 8.7	154000	575	3	60	19.3	21.5	N/A	1-3/8 Stub	7/8 Stub

Hermetic Compressors

ZRT- Even Tandems/ ZRU-Uneven Tandems R-22/407C

3 Phase 200/230V, 460V, 60HZ



Features:

- ZR'S for high efficiency – EER 11.0 plus
- Low Noise & Vibration levels
- Inherent motor protection
- Centrifugal oil pump
- For Heat Pump & Air Conditioning duty
- POE Oil

Part Number	Refrigerant	MTG ARR	Capacity	Voltage	Phase	Hz	RLA	Height	Run Cap	Suction	Discharge
ZRT122K3E-TFD-831	22	7.5 x 7.5	121000	460	3	60	1	18.8	N/A	1-1/8 Stub	3/4 Stub
ZRT144KCE-TFD-950	22	7.5 x 7.5	144000	460	3	60	1	18.8	N/A	1-1/8 Stub	3/4 Stub
ZRT188KCE-TFD-950	22	7.5 x 7.5	186500	460	3	60	1	19.5	N/A	1-5/8 Stub	1-3/8 Stub
ZRT250KCE-TFD-950	22	10.5 x 10.5	237000	460	3	60	1	22.7	N/A	1-5/8 Stub	1-3/8 Stub
ZRT250KCE-TFD-975	22	10.5 x 10.5	237000	460	3	60	1	22.7	N/A	1-5/8 Stub	1-3/8 Stub
ZRT90KCE-TF5-830	22	7.5 x 7.5	90500	200/230	3	60	1	18.0	N/A	1-1/8 Stub	3/4 Stub
ZRT122K3E-TF5-831	22	7.5 x 7.5	121000	200/230	3	60	1	18.8	N/A	1-1/8 Stub	3/4 Stub
ZRT144KCE-TF5-950	22	7.5 x 7.5	144000	200/230	3	60	1	18.8	N/A	1-1/8 Stub	3/4 Stub
ZRU140KCE-TFD-980	22	7.5 x 7.5	141000	460	3	60	1	18.8	N/A	1-1/8 Stub	3/4 Stub
ZRU140KCE-TF5-980	22	7.5 x 7.5	141000	200/230	3	60	1	18.8	N/A	1-1/8 Stub	3/4 Stub

HERMETIC COMPRESSORS - COPELAND SCROLLS

Hermetic Scroll - R-410A

Single Phase 208/230V, 265V, 60HZ

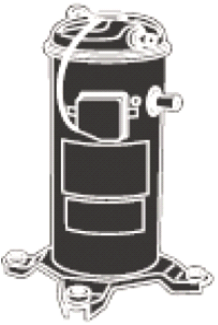

Features:

- ZP'S for high efficiency – EER 11.0 plus
- Low Noise & Vibration levels
- Inherent motor protection
- Centrifugal oil pump
- For Heat Pump & Air Conditioning duty
- POE Oil

Part Number	Refrigerant	MTG ARR	Capacity	Voltage	Phase	Hz	RLA	Height	Run Cap	Suction	Discharge
ZP16K5E-PFV-830	410A	7.5 x 7.5	15500	208/230	1	60	10.0	14.3	30/370	3/4 H 10.3	1/2 H 14.15
ZP16KAE-PFV-830	410A	7.5 x 7.5	15650	208/230	1	60	10.4	14.9	30/370	3/4 Stub	1/2 Stub
ZP20K5E-PFV-830	410A	7.5 x 7.5	20000	208/230	1	60	15.0	15.3	35/370	3/4 H 10.3	1/2 H 14.15
ZP20KAE-PFV-830	410A	7.5 x 7.5	20000	208/230	1	60	12.5	14.9	35/370	3/4 Stub	1/2 Stub
ZPS20K5E-PFV-830	410A	7.5 x 7.5	20200	208/230	1	60	13.0	15.3	35/370	3/4 Stub	1/2 Stub
ZP21K5E-PFV-830	410A	7.5 x 7.5	21300	208/230	1	60	14.3	15.3	40/370	3/4 H 10.3	1/2 H 14.15
ZPS21K5E-PFV-830	410A	7.5 x 7.5	21300	208/230	1	60	12.4	15.3	35/370	3/4 Stub	1/2 Stub
ZP24K5E-PFV-830	410A	7.5 x 7.5	24000	208/230	1	60	14.3	15.3	40/370	3/4 H 10.3	1/2 H 14.15
ZP25K5E-PFV-830	410A	7.5 x 7.5	25200	208/230	1	60	15.7	15.3	40/370	3/4 H 10.3	1/2 H 14.15
ZP28K5E-PFV-830	410A	7.5 x 7.5	27900	208/230	1	60	17.9	15.3	45/370	3/4 H 10.3	1/2 H 14.15
ZP29K5E-PFV-830	410A	7.5 x 7.5	29000	208/230	1	60	15.7	15.3	45/370	3/4 H 10.3	1/2 H 14.15
ZP31K5E-PFV-830	410A	7.5 x 7.5	31100	208/230	1	60	18.6	15.3	45/370	3/4 H 10.3	1/2 H 14.15
ZP36K5E-PFV-830	410A	7.5 x 7.5	36000	208/230	1	60	20.0	16.9	45/370	7/8 H 11.50	1/2 H 15.34
ZP38K5E-PFV-830	410A	7.5 x 7.5	37500	208/230	1	60	22.1	16.9	45/370	7/8 H 11.50	1/2 H 15.34
ZP42K5E-PFV-830	410A	7.5 x 7.5	42000	208/230	1	60	24.3	16.9	70/370	7/8 H 11.50	1/2 H 15.34
ZP49K5E-PFV-830	410A	7.5 x 7.5	49400	208/230	1	60	27.9	16.9	70/370	7/8 H 11.50	1/2 H 15.34
ZP51K5E-PFV-830	410A	7.5 x 7.5	51000	208/230	1	60	29.4	16.9	70/370	7/8 H 11.50	1/2 H 15.34
ZP54K5E-PFV-830	410A	7.5 x 7.5	54000	208/230	1	60	29.3	16.9	80/370	7/8 H 11.50	1/2 H 15.34
ZP57K5E-PFV-830	410A	7.5 x 7.5	57000	208/230	1	60	31.6	16.9	80/370	7/8 H 11.68	1/2 H 15.87
ZP20K5E-PFJ-830	410A	7.5 x 7.5	20000	265	1	60	10.0	15.3	40/370	3/4 Stub	1/2 Stub
ZP21K5E-PFJ-830	410A	7.5 x 7.5	21300	265	1	60	10.7	15.3	40/370	3/4 Stub	1/2 Stub
ZP24K5E-PFJ-830	410A	7.5 x 7.5	24000	265	1	60	12.1	15.3	40/370	3/4 Stub	1/2 Stub
ZP31K5E-PFJ-830	410A	7.5 x 7.5	31100	265	1	60	15.0	15.3	60/370	3/4 Stub	1/2 Stub
ZP36K5E-PFJ-830	410A	7.5 x 7.5	36000	265	1	60	17.9	19.9	60/370	7/8 Stub	1/2 Stub

HERMETIC COMPRESSORS - COPELAND SCROLLS

Hermetic Scroll - R-410A

3 Phase 208/230V, 460V, 575V, 60HZ

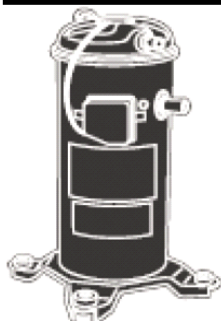

Features:

- ZP'S for high efficiency – EER 11.0 plus
- Low Noise & Vibration levels
- Inherent motor protection
- Centrifugal oil pump
- For Heat Pump & Air Conditioning duty
- POE Oil

Part Number	Refrigerant	MTG ARR	Capacity	Voltage	Phase	Hz	RLA	Height	Run Cap	Suction	Discharge
ZP72KCE-TF5-7M7	410A	7.5 x 7.5	72000	200/230	3	60	25.9	17.9	N/A	7/8 Stub	1/2 Stub
ZP83KCE-TF5-7M7	410A	7.5 x 7.5	83000	200/230	3	60	27.9	17.9	N/A	7/8 Stub	1/2 Stub
ZP91KCE-TF5-7M7	410A	7.5 x 7.5	90500	200/230	3	60	30.7	17.5	N/A	7/8 Stub	3/4 Stub
ZP24K5E-TF5-830	410A	7.5 x 7.5	24000	208/230	3	60	9.3	15.3	N/A	3/4 H 10.3	1/2 H 14.15
ZP24K5E-TF5-899	410A	7.5 x 7.5	24000	208/230	3	60	9.3	15.3	N/A	3/4 H 10.3	1/2 H 14.15
ZP29K5E-TF5-830	410A	7.5 x 7.5	29000	208/230	3	60	10.0	15.3	N/A	3/4 H 10.3	1/2 H 14.15
ZP31K5E-TF5-830	410A	7.5 x 7.5	31200	208/230	3	60	11.6	15.3	N/A	3/4 H 10.3	1/2 H 14.15
ZP36K5E-TF5-830	410A	7.5 x 7.5	36000	208/230	3	60	15.1	16.9	N/A	7/8 H 11.50	1/2 H 15.34
ZP38K5E-TF5-830	410A	7.5 x 7.5	38000	208/230	3	60	15.1	16.9	N/A	7/8 H 11.50	1/2 H 15.34
ZP42K5E-TF5-830	410A	7.5 x 7.5	42200	208/230	3	60	15.3	16.9	N/A	7/8 H 11.50	1/2 H 15.34
ZP44K5E-TF5-830	410A	7.5 x 7.5	44500	208/230	3	60	16.1	16.9	N/A	7/8 H 11.50	1/2 H 15.34
ZP49K5E-TF5-830	410A	7.5 x 7.5	49700	208/230	3	60	17.7	16.9	N/A	7/8 H 11.50	1/2 H 15.34
ZP51K5E-TF5-830	410A	7.5 x 7.5	51500	208/230	3	60	17.8	16.9	N/A	7/8 H 11.50	1/2 H 15.34
ZP54K5E-TF5-830	410A	7.5 x 7.5	54300	208/230	3	60	17.4	16.9	N/A	7/8 H 11.50	1/2 H 15.34
ZP57K5E-TF5-830	410A	7.5 x 7.5	57500	208/230	3	60	21.4	16.9	N/A	7/8 H 11.68	1/2 H 15.87
ZP61K5E-TF5-830	410A	7.5 x 7.5	61500	208/230	3	60	21.9	16.9	N/A	7/8 H 11.68	1/2 H 15.87
ZP61K5E-TF5-899	410A	7.5 x 7.5	61500	208/230	3	60	21.9	16.9	N/A	7/8 H 11.68	1/2 H 15.87
ZP61KCE-TF5-830	410A	7.5 x 7.5	61500	208/230	3	60	21.2	17.9	N/A	7/8 H 11.73	1/2 H 16.17
ZP67KCE-TF5-830	410A	7.5 x 7.5	67500	208/230	3	60	25.0	17.9	N/A	7/8 H 11.73	1/2 H 16.17
ZP67KCE-TF5-950	410A	7.5 x 7.5	67500	208/230	3	60	25.0	17.9	N/A	7/8 H 11.73	1/2 H 16.17
ZP72KCE-TF5-830	410A	7.5 x 7.5	72000	208/230	3	60	25.9	17.9	N/A	7/8 H 11.73	1/2 H 16.17
ZP76KCE-TF5-830	410A	7.5 x 7.5	77000	208/230	3	60	27.9	17.9	N/A	7/8 H 11.73	1/2 H 16.17
ZP76KCE-TF5-950	410A	7.5 x 7.5	77000	208/230	3	60	27.9	17.9	N/A	7/8 H 11.73	1/2 H 16.17
ZP83KCE-TF5-830	410A	7.5 x 7.5	83000	208/230	3	60	27.9	17.9	N/A	7/8 H 11.73	1/2 H 16.17
ZP83KCE-TF5-950	410A	7.5 x 7.5	83000	208/230	3	60	27.9	17.9	N/A	7/8 H 11.73	1/2 H 16.17
ZP90KCE-TF5-855	410A	7.5 x 7.5	90500	208/230	3	60	32.9	18.8	N/A	1-1/8 H 3.69	7/8 H 17.49
ZP90KCE-TF5-950	410A	7.5 x 7.5	90500	208/230	3	60	32.9	18.8	N/A	1-1/8 H 3.69	7/8 H 17.49
ZP91KCE-TF5-950	410A	7.5 x 7.5	90500	208/230	3	60	30.7	17.5	N/A	7/8 H 11.73	3/4 H 16.17
ZP103KCE-TF5-855	410A	7.5 x 7.5	105000	208/230	3	60	33.6	21.0	N/A	1-3/8 H 4.81	7/8 H 19.73
ZP103KCE-TF5-950	410A	7.5 x 7.5	105000	208/230	3	60	33.6	21.0	N/A	1-3/8 H 4.81	7/8 H 19.73
ZP120KCE-TF5-855	410A	7.5 x 7.5	123000	208/230	3	60	37.1	21.0	N/A	1-3/8 H 4.81	7/8 H 19.73
ZP120KCE-TF5-950	410A	7.5 x 7.5	123000	208/230	3	60	37.1	21.0	N/A	1-3/8 H 4.81	7/8 H 19.73
ZP137KCE-TF5-855	410A	7.5 x 7.5	137000	208/230	3	60	53.6	21.0	N/A	1-3/8 H 4.81	7/8 H 19.73
ZP137KCE-TF5-950	410A	7.5 x 7.5	137000	208/230	3	60	53.6	21.0	N/A	1-3/8 H 4.81	7/8 H 19.73
ZP154KCE-TE5-950	410A	7.5 x 7.5	155000	208/230	3	60	57.1	21.7	N/A	1-3/8 H 5.53	7/8 H 20.46
ZP182KCE-TE5-950	410A	7.5 x 7.5	183000	208/230	3	60	62.1	21.7	N/A	1-3/8 H 5.53	7/8 H 20.46
ZP20K5E-TFD-830	410A	7.5 x 7.5	20000	460	3	60	3.9	15.3	N/A	3/4 H 10.3	1/2 H 14.15
ZP24K5E-TFD-899	410A	7.5 x 7.5	24000	460	3	60	5.7	15.3	N/A	3/4 H 10.3	1/2 H 14.15
ZP25K5E-TFD-830	410A	7.5 x 7.5	25200	460	3	60	4.6	15.3	N/A	3/4 H 10.3	1/2 H 14.15
ZP28K5E-TFD-830	410A	7.5 x 7.5	27700	460	3	60	5.3	15.3	N/A	3/4 H 10.3	1/2 H 14.15



Hermetic Compressors

Part Number	Refrigerant	MTG ARR	Capacity	Voltage	Phase	Hz	RLA	Height	Run Cap	Suction	Discharge
ZP29K5E-TFD-830	410A	7.5 x 7.5	29000	460	3	60	6.3	15.3	N/A	3/4 H 10.3	1/2 H 14.15
ZP31K5E-TFD-830	410A	7.5 x 7.5	31200	460	3	60	6.4	15.3	N/A	3/4 H 10.3	1/2 H 14.15
ZP36K5E-TFD-830	410A	7.5 x 7.5	36000	460	3	60	6.6	16.9	N/A	7/8 H 11.50	1/2 H 15.34
ZP38K5E-TFD-830	410A	7.5 x 7.5	38100	460	3	60	6.8	16.9	N/A	7/8 H 11.50	1/2 H 15.34
ZP39K5E-TFD-899	410A	7.5 x 7.5	39000	460	3	60	4.6	16.9	N/A	7/8 Stub	1/2 Stub
ZP42K5E-TFD-830	410A	7.5 x 7.5	41900	460	3	60	6.9	16.9	N/A	7/8 H 11.50	1/2 H 15.34
ZP49K5E-TFD-830	410A	7.5 x 7.5	50000	460	3	60	7.9	16.9	N/A	7/8 H 11.50	1/2 H 15.34
ZP51K5E-TFD-830	410A	7.5 x 7.5	51600	460	3	60	8.6	16.9	N/A	7/8 H 11.50	1/2 H 15.34
ZP54K5E-TFD-830	410A	7.5 x 7.5	54300	460	3	60	8.6	16.9	N/A	7/8 H 11.50	1/2 H 15.34
ZP57K3E-TFD-930	410A	7.5 x 7.5	58000	460	3	60	10.7	17.9	N/A	7/8 H 11.73	1/2 H 16.17
ZP61K5E-TFD-899	410A	7.5 x 7.5	61500	460	3	60	9.1	16.9	N/A	7/8 H 11.68	1/2 H 15.87
ZP61KCE-TFD-830	410A	7.5 x 7.5	61500	460	3	60	10.9	17.9	N/A	7/8 H 11.73	1/2 H 16.17
ZP61KCE-TFD-950	410A	7.5 x 7.5	61500	460	3	60	10.9	17.9	N/A	7/8 H 11.73	1/2 H 16.17
ZP67KCE-TFD-7M7	410A	7.5 x 7.5	67000	460	3	60	11.8	17.9	N/A	7/8 Stub	1/2 Stub
ZP67KCE-TFD-830	410A	7.5 x 7.5	67000	460	3	60	11.8	17.9	N/A	7/8 H 11.73	1/2 H 16.17
ZP67KCE-TFD-950	410A	7.5 x 7.5	67000	460	3	60	11.8	17.9	N/A	7/8 H 11.73	1/2 H 16.17
ZP72KCE-TFD-7M7	410A	7.5 x 7.5	72000	460	3	60	12.5	17.9	N/A	7/8 Stub	1/2 Stub
ZP72KCE-TFD-830	410A	7.5 x 7.5	72000	460	3	60	12.5	17.9	N/A	7/8 H 11.73	1/2 H 16.17
ZP76KCE-TFD-830	410A	7.5 x 7.5	77000	460	3	60	14.3	17.9	N/A	7/8 H 11.73	1/2 H 16.17
ZP76KCE-TFD-950	410A	7.5 x 7.5	77000	460	3	60	14.3	17.9	N/A	7/8 H 11.73	1/2 H 16.17
ZP83KCE-TFD-7M7	410A	7.5 x 7.5	83000	460	3	60	13.6	17.9	N/A	7/8 Stub	1/2 Stub
ZP83KCE-TFD-830	410A	7.5 x 7.5	83000	460	3	60	13.6	17.9	N/A	7/8 H 11.73	1/2 H 16.17
ZP83KCE-TFD-950	410A	7.5 x 7.5	83000	460	3	60	13.6	17.9	N/A	7/8 H 11.73	1/2 H 16.17
ZP90KCE-TFD-855	410A	7.5 x 7.5	90500	460	3	60	16.4	18.8	N/A	1-1/8 H 3.69	7/8 H 17.49
ZP90KCE-TFD-950	410A	7.5 x 7.5	90500	460	3	60	16.4	18.8	N/A	1-1/8 H 3.69	7/8 H 17.49
ZP91KCE-TFD-7M7	410A	7.5 x 7.5	90500	460	3	60	14.3	17.5	N/A	7/8 Stub	3/4 Stub
ZP91KCE-TFD-950	410A	7.5 x 7.5	90500	460	3	60	14.3	17.5	N/A	7/8 H 11.73	3/4 H 16.17
ZP103KCE-TFD-855	410A	7.5 x 7.5	105000	460	3	60	18.6	21.0	N/A	1-3/8 H 4.81	7/8 H 19.73
ZP103KCE-TFD-950	410A	7.5 x 7.5	105000	460	3	60	18.6	21.0	N/A	1-3/8 H 4.81	7/8 H 19.73
ZP120KCE-TFD-855	410A	7.5 x 7.5	123000	460	3	60	20.0	21.0	N/A	1-3/8 H 4.81	7/8 H 19.73
ZP120KCE-TFD-950	410A	7.5 x 7.5	123000	460	3	60	20.0	21.0	N/A	1-3/8 H 4.81	7/8 H 19.73
ZP137KCE-TFD-855	410A	7.5 x 7.5	135000	460	3	60	20.7	21.0	N/A	1-3/8 H 4.81	7/8 H 19.73
ZP137KCE-TFD-950	410A	7.5 x 7.5	135000	460	3	60	20.7	21.0	N/A	1-3/8 H 4.81	7/8 H 19.73
ZP154KCE-TED-950	410A	7.5 x 7.5	155000	460	3	60	25.7	21.7	N/A	1-3/8 H 5.53	7/8 H 20.46
ZP154KCE-TFD-855	410A	7.5 x 7.5	155000	460	3	60	25.0	21.7	N/A	1-3/8 H 5.53	7/8 H 20.46
ZP182KCE-TED-950	410A	7.5 x 7.5	183000	460	3	60	30.0	21.7	N/A	1-3/8 H 5.53	7/8 H 20.46
ZP182KCE-TFD-855	410A	7.5 x 7.5	183000	460	3	60	29.3	21.7	N/A	1-3/8 H 5.53	7/8 H 20.46
ZP236KCE-TED-750	410A	10.5 x 10.5	238000	460	3	60	34.3	27.2	N/A	1-5/8 H 14.78	1-1/8 H 25.04
ZP29K5E-TFE-830	410A	7.5 x 7.5	29000	575	3	60	4.2	15.3	N/A	3/4 Stub	1/2 Stub
ZP31K5E-TFE-830	410A	7.5 x 7.5	31100	575	3	60	4.2	15.3	N/A	3/4 Stub	1/2 Stub
ZP34K5E-TFE-899	410A	7.5 x 7.5	34600	575	3	60	4.6	16.9	N/A	7/8 Stub	1/2 Stub
ZP36K5E-TFE-830	410A	7.5 x 7.5	36000	575	3	60	5.5	16.9	N/A	7/8 Stub	1/2 Stub
ZP38K5E-TFE-830	410A	7.5 x 7.5	38100	575	3	60	4.6	16.9	N/A	7/8 Stub	1/2 Stub
ZP39K5E-TFE-830	410A	7.5 x 7.5	39000	575	3	60	4.9	16.9	N/A	7/8 Stub	1/2 Stub
ZP42K5E-TFE-830	410A	7.5 x 7.5	42000	575	3	60	5.4	16.9	N/A	7/8 Stub	1/2 Stub
ZP49K5E-TFE-830	410A	7.5 x 7.5	49700	575	3	60	5.7	16.9	N/A	7/8 Stub	1/2 Stub
ZP51K5E-TFE-830	410A	7.5 x 7.5	51000	575	3	60	6.4	16.9	N/A	7/8 Stub	1/2 Stub
ZP54K5E-TFE-830	410A	7.5 x 7.5	54000	575	3	60	6.5	16.9	N/A	7/8 Stub	1/2 Stub
ZP61KCE-TFE-830	410A	7.5 x 7.5	61500	575	3	60	7.4	17.9	N/A	7/8 Stub	1/2 Stub
ZP67KCE-TFE-830	410A	7.5 x 7.5	67500	575	3	60	8.6	17.9	N/A	7/8 Stub	1/2 Stub
ZP72KCE-TFE-830	410A	7.5 x 7.5	71700	575	3	60	8.8	17.9	N/A	7/8 H 11.73	1/2 H 16.17
ZP76KCE-TFE-830	410A	7.5 x 7.5	77000	575	3	60	6.7	17.9	N/A	7/8 Stub	1/2 Stub
ZP76KCE-TFE-950	410A	7.5 x 7.5	77000	575	3	60	6.7	17.9	N/A	7/8 Stub	1/2 Stub
ZP83KCE-TFE-7M7	410A	7.5 x 7.5	83000	575	3	60	10.0	17.9	N/A	7/8 Stub	1/2 Stub
ZP83KCE-TFE-830	410A	7.5 x 7.5	83000	575	3	60	10.0	17.9	N/A	7/8 Stub	1/2 Stub
ZP83KCE-TFE-950	410A	7.5 x 7.5	83000	575	3	60	10.0	17.9	N/A	7/8 Stub	1/2 Stub

HERMETIC COMPRESSORS - COPELAND SCROLLS

Hermetic Scroll - R-410A

3 Phase 208/230V, 460V, 575V, 60HZ

Part Number	Refrigerant	MTG ARR	Capacity	Voltage	Phase	Hz	RLA	Height	Run Cap	Suction	Discharge
ZP90KCE-TFE-950	410A	7.5 x 7.5	90500	575	3	60	13.6	18.8	N/A	1-1/8 H 3.69	7/8 H 17.49
ZP91KCE-TFE-950	410A	7.5 x 7.5	90500	575	3	60	10.7	17.5	N/A	3/4 Stub	7/8 Stub
ZP103KCE-TFE-855	410A	7.5 x 7.5	104000	575	3	60	13.6	21.0	N/A	1-3/8 H 4.81	7/8 H 19.73
ZP103KCE-TFE-950	410A	7.5 x 7.5	104000	575	3	60	13.6	21.0	N/A	1-3/8 H 4.81	7/8 H 19.73
ZP120KCE-TFE-855	410A	7.5 x 7.5	121000	575	3	60	14.3	21.0	N/A	1-3/8 H 4.81	7/8 H 19.73
ZP120KCE-TFE-950	410A	7.5 x 7.5	121000	575	3	60	14.3	21.0	N/A	1-3/8 H 4.81	7/8 H 19.73
ZP137KCE-TFE-855	410A	7.5 x 7.5	136000	575	3	60	16.4	21.0	N/A	1-3/8 H 4.81	7/8 H 19.73
ZP137KCE-TFE-950	410A	7.5 x 7.5	136000	575	3	60	16.4	21.0	N/A	1-3/8 H 4.81	7/8 H 19.73
ZP154KCE-TEE-950	410A	7.5 x 7.5	155000	575	3	60	22.1	21.7	N/A	1-3/8 H 5.53	7/8 H 20.46
ZP182KCE-TEE-950	410A	7.5 x 7.5	183000	575	3	60	26.4	21.7	N/A	1-3/8 H 5.53	7/8 H 20.46

Hermetic Scroll - Digital, R-410A

3 Phase 200/230V, 460V, 575V, 60HZ



Features:

- ZP'S for high efficiency – EER 11.0 plus
- Low Noise & Vibration levels
- Inherent motor protection
- Centrifugal oil pump
- For Heat Pump & Air Conditioning duty
- POE Oil

Part Number	Refrigerant	MTG ARR	Capacity	Voltage	Phase	Hz	RLA	Height	Run Cap	Suction	Discharge
ZPD42K5E-TF5-830	410A	7.5 x 7.5	43000	200/230	3	60	17.9	17.7	N/A	25/32 Stub	1/2 Stub
ZPD54K5E-TF5-830	410A	7.5 x 7.5	54600	200/230	3	60	18.8	18.8	N/A	25/32 Stub	1/2 Stub
ZPD103KCE-TF5-855	410A	7.5 x 7.5	105000	200/230	3	60	33.6	21.0	N/A	1-3/8 Stub	7/8 Stub
ZPD103KCE-TF5-950	410A	7.5 x 7.5	105000	200/230	3	60	33.6	21.0	N/A	1-3/8 Stub	7/8 Stub
ZPD120KCE-TF5-855	410A	7.5 x 7.5	123000	200/230	3	60	37.1	21.0	N/A	1-3/8 Stub	7/8 Stub
ZPD137KCE-TF5-855	410A	7.5 x 7.5	137500	200/230	3	60	53.6	21.0	N/A	1-3/8 Stub	7/8 Stub
ZPD154KCE-TE5-950	410A	7.5 x 7.5	155000	200/230	3	60	57.1	22.2	N/A	1-3/8 Stub	7/8 Stub
ZPD182KCE-TE5-950	410A	7.5 x 7.5	183000	200/230	3	60	62.1	22.2	N/A	1-3/8 Stub	7/8 Stub
ZPD51K5E-TFD-830	410A	7.5 x 7.5	51000	460	3	60	8.6	18.4	N/A	7/8 Stub	1/2 Stub
ZPD83KCE-TFD-950	410A	7.5 x 7.5	83000	460	3	60	14.1	19.5	N/A	7/8 Stub	1/2 Stub
ZPD91KCE-TFD-950	410A	7.5 x 7.5	90100	460	3	60	14.3	18.9	N/A	7/8 Stub	3/4 Stub
ZPD103KCE-TFD-855	410A	7.5 x 7.5	105000	460	3	60	18.6	21.0	N/A	1-3/8 Stub	7/8 Stub
ZPD103KCE-TFD-950	410A	7.5 x 7.5	105000	460	3	60	18.6	21.0	N/A	1-3/8 Stub	7/8 Stub
ZPD120KCE-TFD-855	410A	7.5 x 7.5	123000	460	3	60	20.0	21.0	N/A	1-3/8 Stub	7/8 Stub
ZPD137KCE-TFD-855	410A	7.5 x 7.5	137500	460	3	60	20.7	21.0	N/A	1-3/8 Stub	7/8 Stub
ZPD137KCE-TFD-950	410A	7.5 x 7.5	137500	460	3	60	20.7	21.0	N/A	1-3/8 Stub	7/8 Stub
ZPD154KCE-TED-950	410A	7.5 x 7.5	155000	460	3	60	25.7	22.2	N/A	1-3/8 Stub	7/8 Stub
ZPD182KCE-TED-950	410A	7.5 x 7.5	183000	460	3	60	30.0	22.2	N/A	1-3/8 Stub	7/8 Stub
ZPD120KCE-TFE-855	410A	7.5 x 7.5	121500	575	3	60	14.3	21.0	N/A	1-3/8 Stub	7/8 Stub
ZPD137KCE-TFE-855	410A	7.5 x 7.5	137500	575	3	60	16.4	21.0	N/A	1-3/8 Stub	7/8 Stub
ZPD182KCE-TEE-950	410A	7.5 x 7.5	183000	575	3	60	26.4	22.2	N/A	1-3/8 Stub	7/8 Stub

HERMETIC COMPRESSORS - COPELAND SCROLLS

ZPS-Ultra-Tech / ZPT-Tandems R-410A

Single & 3 Phase 200/230V, 460V, 575V, 60HZ



Features:

- ZP'S for high efficiency – EER 11.0 plus
- Low Noise & Vibration levels
- Inherent motor protection
- Centrifugal oil pump
- For Heat Pump & Air Conditioning duty
- POE Oil

Part Number	Refrigerant	MTG ARR	Capacity	Voltage	Phase	Hz	RLA	Height	Run Cap	Suction	Discharge
ZPS26K5E-PFV-830	410A	7.5 x 7.5	26400	208/230	1	60	14.6	15.3	40/370	3/4 Stub	1/2 Stub
ZPS30K5E-PFV-830	410A	7.5 x 7.5	30600	208/230	1	60	17.0	15.3	40/370	3/4 Stub	1/2 Stub
ZPS31K5E-PFV-830	410A	7.5 x 7.5	31500	208/230	1	60	17.0	15.3	40/370	3/4 Stub	1/2 Stub
ZPS35K5E-PFV-830	410A	7.5 x 7.5	36800	208/230	1	60	20.0	16.9	45/370	7/8 Stub	1/2 Stub
ZPS40K5E-PFV-830	410A	7.5 x 7.5	41200	208/230	1	60	23.6	16.9	30/370	7/8 Stub	1/2 Stub
ZPS49K5E-PFV-830	410A	7.5 x 7.5	49100	208/230	1	60	32.1	16.9	40/440	7/8 Stub	1/2 Stub
ZPS51K5E-PFV-830	410A	7.5 x 7.5	52000	208/230	1	60	30.2		40/440	7/8 Stub	1/2 Stub
ZPS30K5E-TF5-830	410A	7.5 x 7.5	30600	208/230	3	60	12.9	15.3	N/A	3/4 Stub	1/2 Stub
ZPS40K5E-TF5-830	410A	7.5 x 7.5	41200	208/230	3	60	15.6	16.9	N/A	7/8 Stub	1/2 Stub
ZPS49K5E-TF5-830	410A	7.5 x 7.5	49300	208/230	3	60	18.1	16.9	N/A	7/8 Stub	1/2 Stub
ZPS30K5E-TFD-830	410A	7.5 x 7.5	30600	460	3	60	6.4	15.3	N/A	3/4 Stub	1/2 Stub
ZPS40K5E-TFD-830	410A	7.5 x 7.5	41200	460	3	60	7.1	16.9	N/A	7/8 Stub	1/2 Stub
ZPS49K5E-TFD-830	410A	7.5 x 7.5	49300	460	3	60	8.5	16.9	N/A	7/8 Stub	1/2 Stub
ZPS49K5E-TFE-830	410A	7.5 x 7.5	49300	575	3	60	5.9	16.9	N/A	7/8 Stub	1/2 Stub
ZPT180KCE-TF5-975	410A	7.5 x 7.5	181000	200/230	3	60	1.0	19.5	N/A	1-5/8 Stub	1-3/8 Stub
ZPT240KCE-TFD-975	410A	7.5 x 7.5	246000	460	3	60	1.0	22.7	N/A	1-5/8 Stub	1-3/8 Stub

HERMETIC COMPRESSORS - DANFOSS SCROLLS

Hermetic Performer Black - R-22

Compressor Part Numbering System

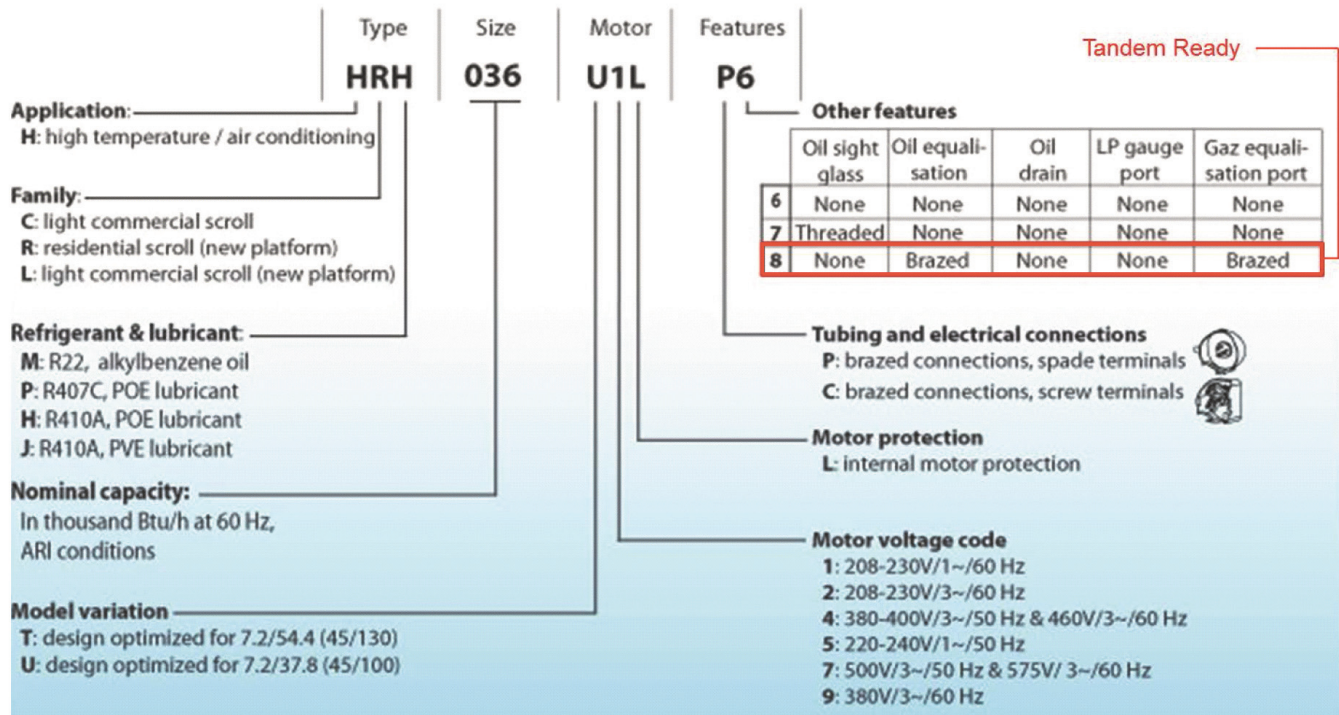

Hermetic Compressors

Single Phase 208/230V, 60HZ

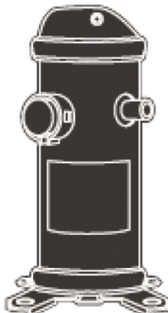

Features:

- Low Noise & Vibration levels
- High efficiency
- High reliability
- For Heat Pump & Air Conditioning duty
- Compact & lightweight

Part Number	Refrigerant	MTG ARR	Capacity	Voltage	Phase	Hz	RLA	Height	Run Cap	Suction	Discharge
HRM034U1LP6	22	7.5 x 7.5	34112	208/230	1	60	16.7	15.5	45/370	3/4 H 9.8	1/2 H14.9
HRM038U1LP6	22	7.5 x 7.5	38010	208/230	1	60	19.5	15.5	55/370	3/4 H 9.8	1/2 H14.9
HRM040U1LP6	22	7.5 x 7.5	40010	208/230	1	60	21.0	15.5	60/370	3/4 H 9.8	1/2 H14.9
HRM042U1LP6	22	7.5 x 7.5	42017	208/230	1	60	21.0	15.5	60/370	3/4 H 9.8	1/2 H14.9
HRM045U1LP6	22	7.5 x 7.5	45039	208/230	1	60	23.0	16.5	70/370	7/8 H 10.8	1/2 H15.9
HRM048U1LP6	22	7.5 x 7.5	47743	208/230	1	60	26.6	17.2	60/370	7/8 H 11.0	1/2 H 16.6
HRM054U1LC6	22	7.5 x 7.5	53705	208/230	1	60	25.0	17.2	70/370	7/8 H 11.0	1/2 H 16.6
HRM054U1LP6	22	7.5 x 7.5	53705	208/230	1	60	25.0	17.2	70/370	7/8 H 11.0	1/2 H 16.6
HRM058U1LP6	22	7.5 x 7.5	57710	208/230	1	60	28.8	17.2	80/440	7/8 H 11.0	1/2 H 16.6
HRM058T1LP6	22	7.5 x 7.5	58019	208/230	1	60	28.9	17.2	55/370	7/8 H 11.0	1/2 H 16.6
HRM060U1LC6	22	7.5 x 7.5	59757	208/230	1	60	28.8	17.2	80/440	7/8 H 11.0	1/2 H 16.6
HRM060U1LP6	22	7.5 x 7.5	59757	208/230	1	60	28.8	17.2	80/440	7/8 H 11.0	1/2 H 16.6
HRM060T1LC6	22	7.5 x 7.5	60030	208/230	1	60	28.9	17.2	55/440	7/8 H 11.0	1/2 H 16.6
HRM060T1LP6	22	7.5 x 7.5	60030	208/230	1	60	28.9	17.2	55/440	7/8 H 11.0	1/2 H 16.6

HERMETIC COMPRESSORS - DANFOSS SCROLLS

Hermetic Performer Black - R-22

3 Phase 208/230V, 460V, 575V, 60HZ

Hermetic Compressors

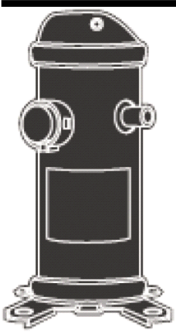

Features:

- Low Noise & Vibration levels
- High efficiency
- High reliability
- For Heat Pump & Air Conditioning duty
- Compact & lightweight

Part Number	Refrigerant	MTG ARR	Capacity	Voltage	Phase	Hz	RLA	Height	Run Cap	Suction	Discharge
HRM034U2LP6	22	7.5 x 7.5	33510	208/230	3	60	11.2	15.5	N/A	3/4 H 9.8	1/2 H14.9
HRM038U2LP6	22	7.5 x 7.5	38011	208/230	3	60	12.2	15.5	N/A	3/4 H 9.8	1/2 H14.9
HRM042U2LP6	22	7.5 x 7.5	42018	208/230	3	60	14.1	15.5	N/A	3/4 H 9.8	1/2 H14.9
HRM045U2LP6	22	7.5 x 7.5	45045	208/230	3	60	16.0	16.5	N/A	7/8 H 10.8	1/2 H 15.9
HRM047U2LP6	22	7.5 x 7.5	47504	208/230	3	60	16.0	16.5	N/A	7/8 H 10.8	1/2 H15.9
HRM054U2LC6	22	7.5 x 7.5	53720	208/230	3	60	16.7	17.2	N/A	7/8 H 11.0	1/2 H 16.6
HRM054U2LP6	22	7.5 x 7.5	53720	208/230	3	60	17.3	17.2	N/A	7/8 H 11.0	1/2 H 16.6
HRM058T2LC6	22	7.5 x 7.5	57807	208/230	3	60	0		N/A		
HRM058U2LP6	22	7.5 x 7.5	57808	208/230	3	60	17.3	17.2	N/A	7/8 H 11.0	1/2 H 16.6
HRM060T2LP6	22	7.5 x 7.5	59700	208/230	3	60	16.7	17.2	N/A	7/8 H 11.0	1/2 H 16.6
HRM060U2LC6	22	7.5 x 7.5	59723	208/230	3	60	17.9	17.2	N/A	7/8 H 11.0	1/2 H 16.6
HRM060U2LP6	22	7.5 x 7.5	59723	208/230	3	60	17.9	17.2	N/A	7/8 H 11.0	1/2 H 16.6
HLM068T2LC6	22	7.5 x 7.5	68950	208/230	3	60	19.2	17.2	N/A	7/8 H 11	1/2 H 16.6
HLM068T2LP6	22	7.5 x 7.5	68950	208/230	3	60	19.2	17.2	N/A	7/8 H 11	1/2 H 16.6
HLM072T2LC6	22	7.5 x 7.5	72806	208/230	3	60	19.2	17.2	N/A	7/8 H 11.0	1/2 H 16.6
HLM075T2LC6	22	7.5 x 7.5	75545	208/230	3	60	22.4	17.2	N/A	7/8 H 11.0	1/2 H 16.6
HLM075T2LP6	22	7.5 x 7.5	75545	208/230	3	60	22.4	17.2	N/A	7/8 H 11.0	1/2 H 16.6
HCM078T2LC2	22	7.5 x 7.5	78491	208/230	3	60	23.7	17.2	N/A	7/8 H 11.0	3/4 H 16.6
HCM081T2LC2	22	7.5 x 7.5	81516	208/230	3	60	21.1	17.2	N/A	7/8 H 11.0	3/4 H 16.6
HLM081T2LC6	22	7.5 x 7.5	81516	208/230	3	60	21.1	17.2	N/A	7/8 H 11.0	3/4 H 16.6
HCM094T2LC2	22	7.5 x 7.5	94517	208/230	3	60	0		N/A		
HCM094T2LC6	22	7.5 x 7.5	94517	208/230	3	60	25.6	17.2	N/A	1-1/8 H 14.5	7/8 H 20
HRM038U4LP6	22	7.5 x 7.5	38011	460	3	60	6.4	15.5	N/A	3/4 H 9.8	1/2 H14.9
HRM040U4LP6	22	7.5 x 7.5	40011	460	3	60	6.4	15.5	N/A	3/4 H 9.8	1/2 H14.9
HRM042U4LP6	22	7.5 x 7.5	42018	460	3	60	7.1	15.5	N/A	3/4 H 9.8	1/2 H14.9
HRM045U4LP6	22	7.5 x 7.5	45045	460	3	60	7.7	16.5	N/A	7/8 H 10.8	1/2 H15.9
HRM048U4LP6	22	7.5 x 7.5	47205	460	3	60	8.0	17.2	N/A	7/8 H 11.0	1/2 H 16.6
HRM054U4LC6	22	7.5 x 7.5	53720	460	3	60	8.4	17.2	N/A	7/8 H 11.0	1/2 H 16.6
HRM054U4LP6	22	7.5 x 7.5	53733	460	3	60	8.4	17.2	N/A	7/8 H 11.0	1/2 H 16.6
HRM058U4LP6	22	7.5 x 7.5	57808	460	3	60	9.6	17.2	N/A	7/8 H 11.0	1/2 H 16.6
HRM060T4LP6	22	7.5 x 7.5	59716	460	3	60	9.6	17.2	N/A	7/8 H 11.0	1/2 H 16.6
HRM060U4LC6	22	7.5 x 7.5	59723	460	3	60	9.6	17.2	N/A	7/8 H 11.0	1/2 H 16.6
HRM060U4LP6	22	7.5 x 7.5	59723	460	3	60	9.6	17.2	N/A	7/8 H 11.0	1/2 H 16.6
HCM068T4LP6	22	7.5 x 7.5	68917	460	3	60	9.6	17.2	N/A	7/8 H 11.0	1/2 H 16.6
HLM068T4LC6	22	7.5 x 7.5	68949	460	3	60	9.6	17.2	N/A	7/8 H 11	1/2 H 16.6
HLM075T4LP6	22	7.5 x 7.5	75545	460	3	60	10.3	17.2	N/A	7/8 H 11.0	1/2 H 16.6
HLM075T4LC6	22	7.5 x 7.5	75560	460	3	60	10.3	17.2	N/A	7/8 H 11.0	1/2 H 16.6
HCM078T4LC2	22	7.5 x 7.5	78514	460	3	60	0		N/A		
HLM078T4LC6	22	7.5 x 7.5	78514	460	3	60	10.3	17.2	N/A	7/8 H 11.0	3/4 H 16.6
HCM081T4LC2	22	7.5 x 7.5	81516	460	3	60	11.0	17.2	N/A	7/8 H 11.0	3/4 H 16.6

HERMETIC COMPRESSORS - DANFOSS SCROLLS

Hermetic Performer Black - R-22

3 Phase 208/230V, 460V, 575V, 60HZ

Part Number	Refrigerant	MTG ARR	Capacity	Voltage	Phase	Hz	RLA	Height	Run Cap	Suction	Discharge
HCM094T4LC2	22	7.5 x 7.5	94517	460	3	60	13.5	17.2	N/A	1-1/8 H 14.5	7/8 H 20
HCM094T4LC6	22	7.5 x 7.5	94517	460	3	60	13.5	17.2	N/A	1-1/8 H 14.5	7/8 H 20
HRM047U7LP6	22	7.5 x 7.5	39273	575	3	60	6.4	16.5	N/A	7/8 H 10.8	1/2 H 15.9
HRM045U7LP6	22	7.5 x 7.5	45015	575	3	60	6.0	16.5	N/A	7/8 H 10.8	1/2 H 15.9
HRM054U7LC6	22	7.5 x 7.5	53705	575	3	60	7.0	17.2	N/A	7/8 H 11.0	1/2 H 16.6
HRM054U7LP6	22	7.5 x 7.5	53705	575	3	60	7.0	17.2	N/A	7/8 H 11.0	1/2 H 16.6
HRM058U7LP6	22	7.5 x 7.5	57807	575	3	60	7.4	17.2	N/A	7/8 H 11.0	1/2 H 16.6
HRM060U7LC6	22	7.5 x 7.5	59707	575	3	60	7.4	17.2	N/A	7/8 H 11.0	1/2 H 16.6
HLM075T7LC6	22	7.5 x 7.5	76406	575	3	60	9.0	17.2	N/A	7/8 H 11.0	1/2 H 16.6
HLM075T7LP6	22	7.5 x 7.5	76406	575	3	60	9.0	17.2	N/A	7/8 H 11.0	1/2 H 16.6
HCM081T7LC2	22	7.5 x 7.5	81516	575	3	60	0		N/A		
HCM094T7LC2	22	7.5 x 7.5	94517	575	3	60	0		N/A		

Hermetic Scroll - R-410A

Single & 3 Phase 208/230V, 460V, 60HZ

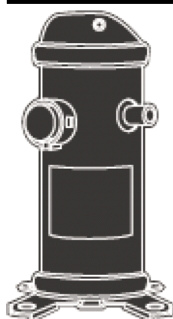

Features:

- Low Noise & Vibration levels
- High efficiency
- High reliability
- For Heat Pump & Air Conditioning duty
- Compact & lightweight

Part Number	Refrigerant	MTG ARR	Capacity	Voltage	Phase	Hz	RLA	Height	Run Cap	Suction	Discharge
HRH029U1LP6	410A	7.5 x 7.5	29000	208/230	1	60	17.0	15.5	45/370	3/4 H 9.8	1/2 H 14.9
HRH031U1LP6	410A	7.5 x 7.5	31000	208/230	1	60	17.0	15.5	45/370	3/4 H 9.8	1/2 H 14.9
HRH036U1LP6	410A	7.5 x 7.5	35400	208/230	1	60	21.5	15.5	55/370	3/4 H 9.8	1/2 H 14.9
HRH039U1LP6	410A	7.5 x 7.5	39500	208/230	1	60	21.0	16.5	60/370	7/8 H 10.8	1/2 H 15.9
HRH040U1LP6	410A	7.5 x 7.5	41503	208/230	1	60	21.0	16.5	60/370	7/8 H 10.8	1/2 H 15.9
HRH050U1LP6	410A	7.5 x 7.5	51000	208/230	1	60	27.5	16.5	70/370	7/8 H 11	1/2 H 16.6
HRH051U1LP6	410A	7.5 x 7.5	51820	208/230	1	60	26.3	17.2	70/440	7/8 H 11	1/2 H 16.6
HRH054U1LP6	410A	7.5 x 7.5	54520	208/230	1	60	29.0	17.2	80/440	7/8 H 11	1/2 H 16.6
HRH054U2LP6	410A	7.5 x 7.5	54529	208/230	3	60	17.3	17.2	N/A	7/8 H 11	1/2 H 16.6
ECH087T2LC2	410A	7.5 x 7.5	95300	208/230	3	60	28.2	21.7	N/A	1-1/8 H 14.7	7/8 H 20.6
ECH087T2LC6	410A	7.5 x 7.5	95300	208/230	3	60	28.2	21.7	N/A	1-1/8 H 14.7	7/8 H 20.6
ECH101T2LC6	410A	7.5 x 7.5	110600	208/230	3	60	15.4	21.7	N/A	1-1/8 H 14.7	7/8 H 20.6
ECH087T4LC2	410A	7.5 x 7.5	95300	460	3	60	15.4	21.7	N/A	1-1/8 H 14.7	7/8 H 20.6
ECH087T4LC6	410A	7.5 x 7.5	95300	460	3	60	15.4	21.7	N/A	1-1/8 H 14.7	7/8 H 20.6
ECH101T4LC2	410A	7.5 x 7.5	110600	460	3	60	0	0	N/A		
ECH101T4LC6	410A	7.5 x 7.5	110600	460	3	60	15.4	21.7	N/A	1-1/8 H 14.7	7/8 H 20.6

HERMETIC COMPRESSORS - DANFOSS SCROLLS

Commercial Performer Blue R-22/R-410A (Trane Drop-In Replacements)

3 Phase 208/230V, 460V, 575V, 60HZ

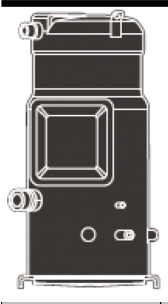

- Features:**
- Low Noise & Vibration levels
 - High efficiency
 - High reliability
 - Universal scroll replacement

Part Number	Refrigerant	MTG ARR	Capacity	Voltage	Phase	Hz	RLA	Height	Run Cap	Suction	Discharge
SM090-3VI	22	8.7 x 8.7	90049	208/230	3	60	25.0	20.0	N/A	1-1/8 H 5.6	3/4 H 18.3
SM115-3QAI	22	8.5 x 12	115200	208/230	3	60	37.1	22.0	N/A	1-3/8 H 7.1	7/8 H 21.2
SM125-3QAI	22	8.5 x 12	125000	208/230	3	60	37.1	21.3	N/A	1-3/8 H 7.1	7/8 H 21.2
SM175-3QAI	22	11 x 12	174355	208/230	3	60	53.6	25.6	N/A	1-5/8 H 7.1	1-1/8 H 25.3
SM185-3QAI	22	11 x 12	185474	208/230	3	60	53.6	25.6	N/A	1-5/8 H 7.1	1-1/8 H 25.3
SM090-4VI	22	8.7 x 8.7	90049	460	3	60	0		N/A		
SM115-4QAI	22	8.5 x 12	115200	460	3	60	17.9	22.0	N/A	1-3/8 H 7.1	7/8 H 21.2
SM125-4QAI	22	8.5 x 12	125000	460	3	60	17.9	21.3	N/A	1-3/8 H 7.1	7/8 H 21.2
SM175-4QAI	22	11 x 12	174355	460	3	60	25.0	25.6	N/A	1-5/8 H 7.1	1-1/8 H 25.3
SM185-4QAI	22	11 x 12	185474	460	3	60	25.0	25.6	N/A	1-5/8 H 7.1	1-1/8 H 25.3
SH090A3ALC	410A	7.5 x 7.5	92543	208/230	3	60	30.7	19.0	N/A	1-1/8 H 9.3	7/8 H 17.8
SH105A3ALC	410A	7.5 x 7.5	109617	208/230	3	60	32.9	21.3	N/A	1-3/8 H 10.9	7/8 H 20.0
SH120A3ALC	410A	7.5 x 7.5	125493	208/230	3	60	43.6	21.3	N/A	1-3/8 H 10.9	7/8 H 20.0
SH140A3ALC	410A	7.5 x 7.5	144445	208/230	3	60	45.7	21.3	N/A	1-3/8 H 10.9	7/8 H 20.0
SH161A3ALC	410A	7.5 x 7.5	161003	208/230	3	60	49.3	21.3	N/A	1-3/8 H 10.9	7/8 H 20.0
SH184A3ALC	410A	7.5 x 7.5	184359	208/230	3	60	53.6	21.9	N/A	1-3/8 H 11.8	7/8 H 20.7
SH240A3ABE	410A	11 x 12	251796	208/230	3	60	75.0	26.9	N/A	1-5/8 H 13	1-1/8 H 25.5
SH090A4ALC	410A	7.5 x 7.5	92543	460	3	60	14.3	19.0	N/A	1-1/8 H 9.3	7/8 H 17.8
SH105A4ALC	410A	7.5 x 7.5	109617	460	3	60	17.9	21.3	N/A	1-3/8 H 10.9	7/8 H 20.0
SH120A4ALC	410A	7.5 x 7.5	125493	460	3	60	20.7	21.3	N/A	1-3/8 H 10.9	7/8 H 20.0
SH140A4ALC	410A	7.5 x 7.5	144445	460	3	60	21.4	21.3	N/A	1-3/8 H 10.9	7/8 H 20.0
SH161A4ALC	410A	7.5 x 7.5	161003	460	3	60	23.6	21.3	N/A	1-3/8 H 10.9	7/8 H 20.0
SH184A4ALC	410A	7.5 x 7.5	184359	460	3	60	27.6	21.9	N/A	1-3/8 H 11.8	7/8 H 20.7
SH161A7ALC	410A	7.5 x 7.5	161003	575	3	60	20.7	21.3	N/A	1-3/8 H 10.9	7/8 H 20.0

HERMETIC COMPRESSORS - DANFOSS SCROLLS

Hermetic Commercial (P040/P045 Models) R-22/R-410A

Compressor Part Numbering System

Example:

P	040	1	8	5	7	1
Parts	Part Code	Capacity (1000) btuh/hr			Voltage	Numerical Sequence
	040	Commercial Compressor – R-22				
	045	Commercial Compressor – R-410A				

Voltage	
0	115/1
1	200/1
2	208-230/1
3	230/1
4	200/3
5	208-230/3
6	230/3
7	460/3
8	575/3
9	265/1 or 277/1

HERMETIC COMPRESSORS - DANFOSS SCROLLS

Hermetic Commercial (P040/P045 Models) R-22/R-410A

3 Phase 208/230V, 380V, 460V, 575V, 60HZ

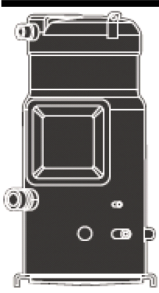

Features:

- Low Noise & Vibration levels
- High efficiency
- High reliability
- For Heat Pump & Air Conditioning duty
- Compact & lightweight

Note: P045 Models with suffix K includes tubing kit.

Part Number	Mfg Number	Refrigerant	MTG ARR	Capacity	Voltage	Phase	Hz	RLA	Height	Run Cap	Suction	Discharge
P040-10751	SM1103VI	22	8.7 x 8.7	107800	208/230	3	60	32.1	21.6	N/A	1-3/8 H 7.0	7/8 H 20.0
P040-11551	SM1153CAI	22	8.5 x 12	115200	208/230	3	60	37.1	22.4	N/A	1-3/8 H 7.0	7/8 H 21.0
P040-12551	SM1203VI	22	8.7 x 8.7	125300	208/230	3	60	35.7	22.0	N/A	1-3/8 H 7.0	7/8 H 20.3
P040-12651	SM1253CAI	22	8.5 x 12	126400	208/230	3	60	37.1	22.9	N/A	1-3/8 H 7.0	7/8 H 21.0
P040-16251	SM1613VI	22	8.7 x 8.7	162600	208/230	3	60	45.7	23.3	N/A	1-3/8 H 7.1	7/8 H 21.9
P040-16351	SM1603CBI	22	8.5 x 12	163000	208/230	3	60	43.6	24.9	N/A	1-5/8 H 7.0	1-1/8 H 23.5
P040-17451	SM1753CAI	22	11 x 12	174300	208/230	3	60	53.6	26.2	N/A	1-5/8 H 6.5	1-1/8 H 24.8
P040-18551	SM1853CAI	22	11 x 12	185400	208/230	3	60	53.6	26.7	N/A	1-5/8 H 7.1	1-1/8 H 25.3
P040-12661	SM1259CAI	22	8.5 x 12	126400	380	3	60	22.9	22.4	N/A	1-3/8 H 7.0	7/8 H 21.0
P040-16361	SM160T9CB	22	8.5 x 12	163000	380	3	60	25.7	24.9	N/A	1-5/8 H 7.0	1-1/8 H 23.5
P040-18561	SM1859CAI	22	11 x 12	185400	380	3	60	33.6	26.7	N/A	1-5/8 H 7.0	1-1/8 H 25.3
P040-10771	SM1104VI	22	8.7 x 8.7	107800	460	3	60	15.7	21.6	N/A	1-3/8 H 7.0	7/8 H 20.0
P040-11571	SM1154CAI	22	8.5 x 12	115200	460	3	60	17.9	22.4	N/A	1-3/8 H 7.0	7/8 H 21.0
P040-12571	SM1204VI	22	8.7 x 8.7	125300	460	3	60	20.7	22.0	N/A	1-3/8 H 7.0	7/8 H 20.3
P040-12671	SM1254CAI	22	8.5 x 12	126400	460	3	60	17.9	22.9	N/A	1-3/8 H 7.0	7/8 H 21.0
P040-16271	SM1614VI	22	8.7 x 8.7	162600	460	3	60	22.9	22.9	N/A	1-3/8 H 7.1	7/8 H 21.9
P040-16371	SM1604CBI	22	8.5 x 12	163000	460	3	60	20.7	24.9	N/A	1-5/8 H 7.0	1-1/8 H 23.5
P040-17471	SM1754CAI	22	11 x 12	174300	460	3	60	25.0	26.2	N/A	1-5/8 H 6.5	1-1/8 H 24.8
P040-18571	SM1854CAI	22	11 x 12	185400	460	3	60	25.0	26.7	N/A	1-5/8 H 7.1	1-1/8 H 25.3
P040-10781	SM1107VI	22	8.7 x 8.7	107800	575	3	60	12.9	21.6	N/A	1-3/8 H 7.0	7/8 H 20.0
P040-11581	SM1157CAI	22	8.5 x 12	115200	575	3	60	13.6	22.4	N/A	1-3/8 H 7.0	7/8 H 21.0
P040-12581	SM1207VI	22	8.7 x 8.7	125300	575	3	60	13.6	22.0	N/A	1-3/8 H 7.0	7/8 H 20.3
P040-12681	SM1257CAI	22	8.5 x 12	126400	575	3	60	13.6	22.4	N/A	1-3/8 H 7.0	7/8 H 21.0
P040-16281	SM1617VI	22	8.7 x 8.7	162600	575	3	60	17.9	23.3	N/A	1-3/8 H 7.1	7/8 H 21.9
P040-16381	SM1607CBI	22	8.5 x 12	163000	575	3	60	17.9	24.9	N/A	1-5/8 H 7.0	1-1/8 H 23.5
P040-17481	SM1757CA1	22	11 x 12	174300	575	3	60	20.0	26.2	N/A	1-5/8 H 6.5	1-1/8 H 24.8
P040-18581	SM1857CAI	22	11 x 12	185400	575	3	60	20.0	26.7	N/A	1-5/8 H 7.1	1-1/8 H 25.3
P045-25121K	SH240A3ACB	410A	11 x 12	251796	200/230	3	60	75.0	26.9	N/A	1-5/8 H 13	1-1/8 H 25.5
P045-31721K	SH300A3ACB	410A	11 x 12	317815	200/230	3	60	94.3	27.4	N/A	1-5/8 H 12.4	1-1/8 H 25.2
P045-31751	SH300A3AAE	410A	11 x 12	317815	208/230	3	60	94.3	27.3	N/A	1-5/8 H 13	1-1/8 H 26.1
P045-25061K	SH240A9ACB	410A	11 x 12	250684	380	3	60	42.9	26.9	N/A	1-5/8 H 13	1-1/8 H 25.5
P045-31761K	SH300A9ACB	410A	11 x 12	317812	380	3	60	60.7	27.4	N/A	1-5/8 H 12.4	1-1/8 H 25.2
P040-29571K	SH240A4ACB	410A	11 x 12	246545	460	3	60	36.4	26.9	N/A	1-5/8 Stub	1-1/8 Stub
P045-24671	SH240A4AAE	410A	11 x 12	246545	460	3	60	36.4	25.7	N/A	1-5/8 H 13.0	1 1/8 H 25.5
P045-24672	SH240A4ABE	410A	11 x 12	246545	460	3	60	36.4	25.7	N/A	1-5/8 H 13.0	1 1/8 H 25.5
P045-25071K	SH240A4ACB	410A	11 x 12	250796	460	3	60	36.4	26.9	N/A	1-5/8 H 13	1-1/8 H 25.5
P045-31771K	SH300A4ACB	410A	11 x 12	317535	460	3	60	46.4	27.4	N/A	1-5/8 H 12.4	1-1/8 H 25.2
P045-31772	SH300A4AAE	410A	11 x 12	317535	460	3	60	46.4	27.3	N/A	1-5/8 H 13	1-1/8 H 26.1
P045-25081K	SH240A7ACB	410A	11 x 12	250965	575	3	60	29.3	26.9	N/A	1-5/8 H 13	1-1/8 H 25.5
P045-25082	SH240A7AAE	410A	11 x 12	250965	575	3	60	29.3	25.7	N/A	1-5/8 H 13	1-1/8 H 25.5
P045-31681K	SH300A7ACB	410A	11 x 12	316716	575	3	60	37.9	27.4	N/A	1-5/8 H 12.4	1-1/8 H 25.2

HERMETIC COMPRESSORS - LG SCROLLS

Compressor Part Numbering System

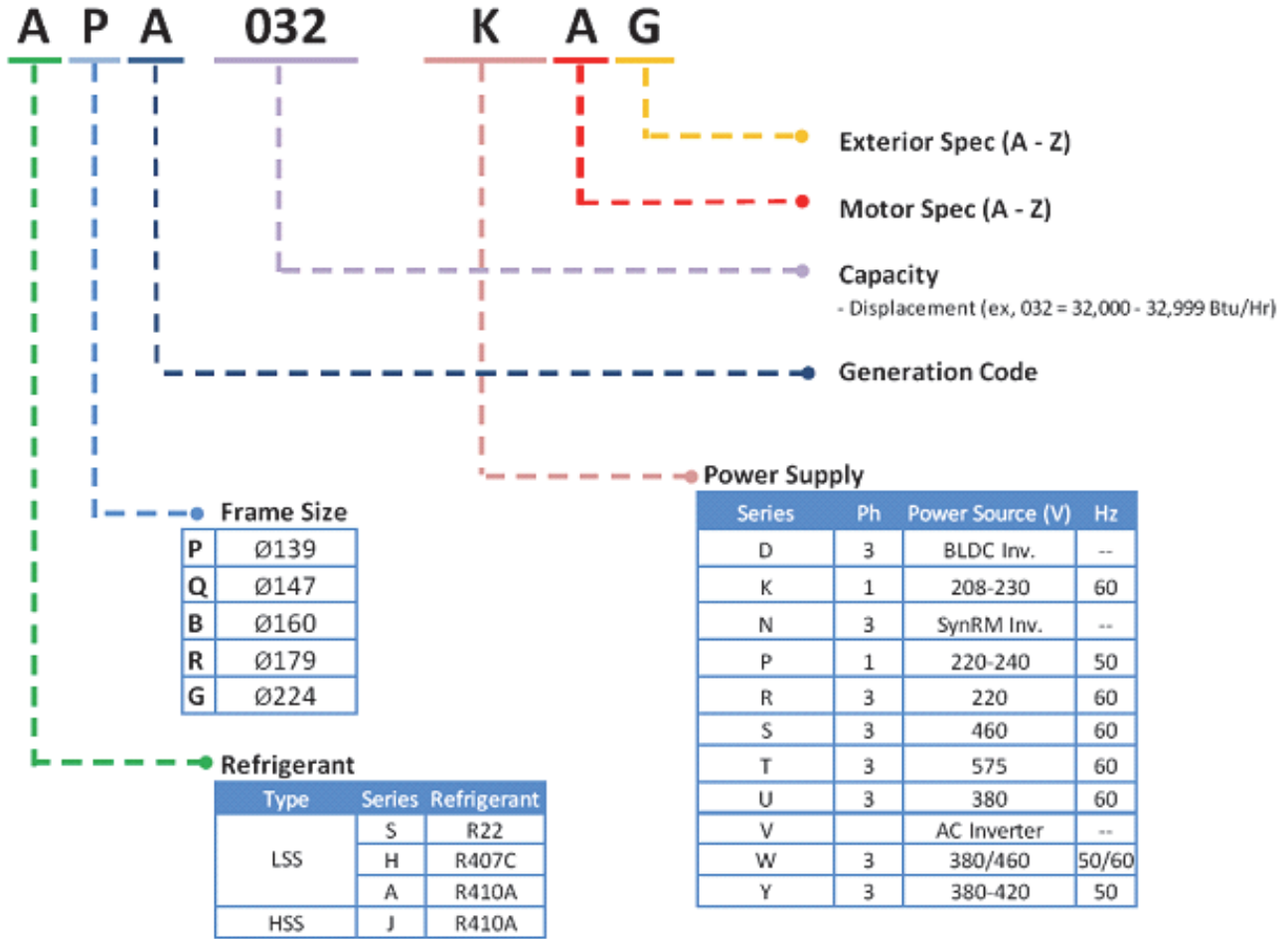

HERMETIC COMPRESSORS - LG SCROLLS

Hermetic Scroll R-22/R-410A

Single & 3 Phase 208/230V, 460V, 60HZ

Hermetic Compressors



Features:

- Low Noise & Vibration levels
- High efficiency
- High reliability
- For Heat Pump & Air Conditioning duty
- Compact & lightweight

Part Number	Refrigerant	MTG ARR	Capacity	Voltage	Phase	Hz	RLA	Height	Run Cap	Suction	Discharge
SQA022KAB	22	7.5 x 7.5	21500	208/230	1	60	9.0	16.5	35/440	3/4 H 11.12	1/2 H 15.41
SQA026KAB	22	7.5 x 7.5	26100	208/230	1	60	10.5	16.5	35/440	3/4 H 11.12	1/2 H 15.41
SQA032KAB	22	7.5 x 7.5	32300	208/230	1	60	13.0	16.5	45/440	3/4 H 11.12	1/2 H 15.41
SQA038KAB	22	7.5 x 7.5	37000	208/230	1	60	15.0	16.5	50/440	3/4 H 11.12	1/2 H 15.41
SQA042KAB	22	7.5 x 7.5	41200	208/230	1	60	17.5	16.5	50/440	3/4 H 11.12	1/2 H 15.41
SR047KBE	22	7.5 x 7.5	47600	208/230	1	60	19.0	18.4	60/440	7/8 H 12.79	1/2 H 17.24
SRA053KAB	22	7.5 x 7.5	53500	208/230	1	60	21.0	18.4	70/440	7/8 H 12.79	1/2 H 17.24
SR057KCC	22	7.5 x 7.5	58000	208/230	1	60	24.0	18.4	70/440	7/8 H 12.79	1/2 H 17.24
SR061RBD	22	7.5 x 7.5	62000	208/230	3	60	17.0	17.6	N/A	7/8 H 11.50	1/2 H 15.9
SR061SAB	22	7.5 x 7.5	61500	460	3	60	7.8	17.6	N/A	7/8 H 11.50	1/2 H 15.90
APA016KAC	410A	7.5 x 7.5	15200	208/230	1	60	8.0	16.0	35/370	3/4 H 9.83	1/2 H 14.93
APA020KAC	410A	7.5 x 7.5	19500	208/230	1	60	10.0	16.0	35/370	3/4 H 9.83	1/2 H 14.93
APA024KAB	410A	7.5 x 7.5	22400	208/230	1	60	10.7	16.0	40/370	3/4 H 9.83	1/2 H 14.93
APA029KAC	410A	7.5 x 7.5	28000	208/230	1	60	13.0	16.0	45/440	3/4 H 9.83	1/2 H 14.93
APA030KAB	410A	7.5 x 7.5	29000	208/230	1	60	13.1	16.0	45/440	3/4 h 9.83	1/2 H 14.93
APA032KAG	410A	7.5 x 7.5	30500	208/230	1	60	14.0	16.0	45/440	3/4 H 9.83	1/2 H 14.93
AQA038KAB	410A	7.5 x 7.5	37700	208/230	1	60	16.5	17.5	60/440	7/8 H 11.94	1/2 H 16.42
AQA039KAC	410A	7.5 x 7.5	39000	208/230	1	60	17.0	17.5	60/440	7/8 H 11.94	1/2 H 16.42
AQA040KAB	410A	7.5 x 7.5	40000	208/230	1	60	17.1	17.85	60/440	7/8 H 12.34	1/2 H 16.81
AQA042KAE	410A	7.5 x 7.5	41500	208/230	1	60	18.0	17.5	70/440	7/8 H 11.94	1/2 H 16.42
ABA049KAB	410A	7.5 x 7.5	48000	208/230	1	60	20.6	17.7	70/440	7/8 H 11.69	1/2 H 16.37
ABA051KAF	410A	7.5 x 7.5	51500	208/230	1	60	21.7	17.7	75/440	7/8 H 11.69	1/2 H 16.37
ABA054KAC	410A	7.5 x 7.5	54000	208/230	1	60	23.0	17.7	80/440	7/8 H 11.69	1/2 H 16.37

HERMETIC COMPRESSORS - TECUMSEH RECIPS

Compressor Part Numbering System

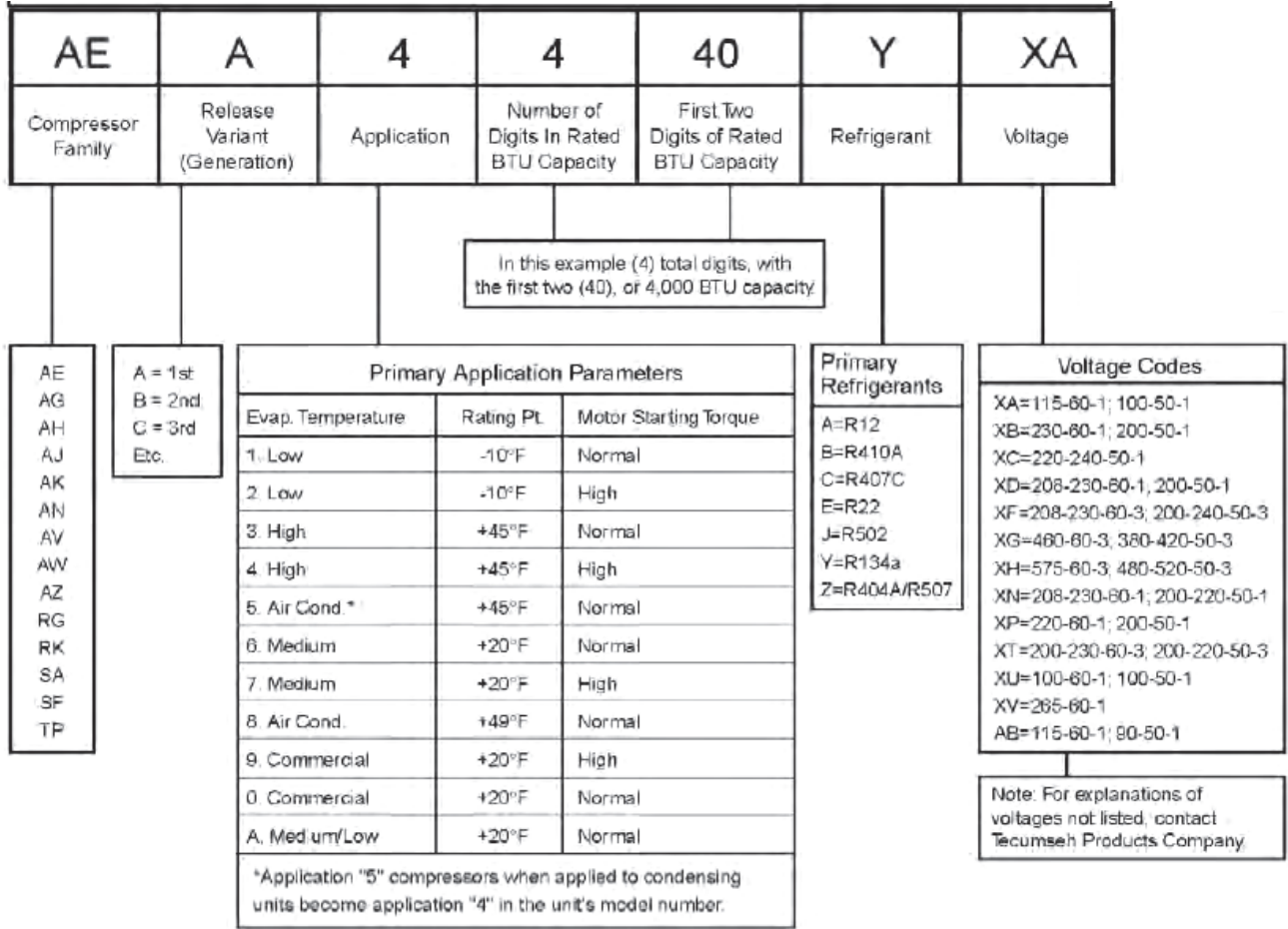

HERMETIC COMPRESSORS - TECUMSEH RECIPS

Hermetic Recip R-22

Single Phase 208/230V, 265, 60HZ

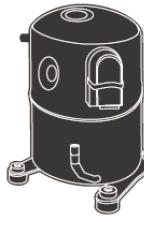

Features:

- Low Noise & Vibration levels
- Adaptable to limited cabinet space
- External line break overload
- For Heat Pump & Air Conditioning duty
- Compact & lightweight

Part Number	Mfg Number	Refrigerant	MTG ARR	Capacity	Voltage	Phase	Hz	RLA	Height	Run Cap	Suction	Discharge
P031-0801	AK130AT004S7Y	22	BRKT	8300	115	1	60	9.0	9.0	15/370	3/8 U	1/4 U
P031-0721	AK123ET009S7Y	22	BRKT	7500	208/230	1	60	2.8	9.5	15/370	3/8 U 9.4	1/4 U 6.7
P031-0821	AK130ET004S7Y	22	BRKT	8300	208/230	1	60	4.4	9.0	15/370	3/8 U	1/4 U
P031-0922	AK145ET009S7Y	22	BRKT	9400	208/230	1	60	3.5	9.4	15/370	3/8 U 9.2	5/16 U 6.7
P031-1221	AK151ET009S7Y	22	BRKT	12000	208/230	1	60	4.6	9.4	25/370	3/8 U 9.2	1/4 U 6.5
P031-1324	AK144ET009S7Y	22	BRKT	13500	208/230	1	60	5.8	9.5	15/370	3/8 U 9.4	1/4 U 6.7
P031-1521	AJ600FT120S7Y	22	4.8 x 8	15000	208/230	1	60	8.5	10.8	20/370	1/2 U	5/16 U
P031-1524	AK147ET009S7Y	22	BRKT	15000	208/230	1	60	6.2	9.4	25/370	3/8 U 9.2	1/4 U 6.5
P031-1527	AW700ET101S7Y	22	7.5 x 7.5	15500	208/230	1	60	7.3	13.1	20/370	5/8 H 11.6	3/8 U 3.9
P031-1721	AJ210FT206S7Y	22	4.8 x 8	17000	208/230	1	60	11.0	11.1	25/370	1/2 U	5/16 U
P031-1723	AW701ET103S7Y	22	7.5 x 7.5	17000	208/230	1	60	7.7	13.1	25/370	5/8 U 12.6	3/8 U 3.9
P031-1724	AW501ET088S7Y	22	7.5 x 7.5	17000	208/230	1	60	6.9	13.1	35/370	3/4 H 11.6	3/8 U 3.9
P031-1921	AJ220FT206S7Y	22	4.8 x 8	19000	208/230	1	60	11.6	11.3	25/370	1/2 U 11.0	5/16 U 4.2
P031-19210	AW503ET088S7Y	22	7.5 x 7.5	19000	208/230	1	60	7.7	13.1	35/370	3/4 H 11.6	3/8 U 3.9
P031-1928	AW702ET093S7Y	22	7.5 x 7.5	19000	208/230	1	60	8.6	13.1	25/370	3/4 H 11.6	3/8 U 3.9
P031-1929	AW702ET103S7Y	22	7.5 x 7.5	19000	208/230	1	60	8.6	13.1	25/370	5/8 U 12.6	3/8 U 3.9
P031-2224	AV122ET004S7Y	22	7.5 x 7.5	22000	208/230	1	60	8.8	13.1	35/370	3/4 H 11.6	3/8 U 3.9
P031-2429	AW505ET088S7Y	22	7.5 x 7.5	24400	208/230	1	60	10.0	13.1	35/370	3/4 H 11.6	3/8 U 3.9
P031-2824	AW706ET093S7Y	22	7.5 x 7.5	28400	208/230	1	60	13.5	13.1	35/370	3/4 H 11.6	3/8 U 3.9
P031-2825	AW507ET088S7Y	22	7.5 x 7.5	28400	208/230	1	60	11.2	13.1	45/370	3/4 H 11.6	3/8 U 3.9
P031-3025	AW707ET103S7Y	22	7.5 x 7.5	30200	208/230	1	60	14.4	13.1	45/370	5/8 U 12.6	3/8 U 3.9
P031-3221	AV113ET002S7Y	22	7.5 x 7.5	31292	208/230	1	60	14.5	14.9	35/370	3/4 U 14.3	3/8 U 5.1
P031-3123	AV113ET026S7Y	22	7.5 x 7.5	31460	208/230	1	60	14.5	14.9	35/370	7/8 H 12.4	1/2 U 5.1
P031-3124	AW708ET093S7Y	22	7.5 x 7.5	31500	208/230	1	60	15.1	13.1	45/370	3/4 H 11.6	3/8 U 3.9
P031-3223	AW509ET088S7Y	22	7.5 x 7.5	32000	208/230	1	60	13.4	13.1	45/370	3/4 H 11.6	3/8 U 3.9
P031-3523	AV122ET004S7Y	22	7.5 x 7.5	34600	208/230	1	60	15.7	14.9	40/370	3/4 U 14.6	3/8 U 5.2
P031-3522	AV125ET041S7Y	22	7.5 x 7.5	35000	208/230	1	60	14.2	14.6	45/370	7/8 H 12.4	1/2 U 5.1
P031-3823	AV135ET005S7Y	22	7.5 x 7.5	37551	208/230	1	60	17.2	14.6	35/440	7/8 U 14.5	1/2 U 5.1
P031-3822	AV133ET003A4Y	22	7.5 x 7.5	37750	208/230	1	60	17.2	15.3	35/440	7/8 H 12.9	1/2 U 5.1
P031-4221	AV146ET005S7Y	22	7.5 x 7.5	41560	208/230	1	60	18.3	14.6	40/440	7/8 U 14.5	1/2 U 5.1
P031-4222	AV147ET041S7Y	22	7.5 x 7.5	42000	208/230	1	60	17.1	14.6	45/440	7/8 H 12.4	1/2 U 5.1
P031-4621	AG111ET004S7Y	22	7.5 x 7.5	46000	208/230	1	60	22.7	15.8	40/440	7/8 U 15.0	1/2 U 4.5
P031-4622	AV168ET041S7Y	22	7.5 x 7.5	46000	208/230	1	60	21.5	14.6	40/440	7/8 H 12.4	1/2 U 5.1
P031-4623	AV177ET005S7Y	22	7.5 x 7.5	46700	208/230	1	60	20.4	14.6	45/440	7/8 U 14.3	1/2 U 5.1
P031-4921	AV178ET041S7Y	22	7.5 x 7.5	49000	208/230	1	60	20.5	14.6	45/440	7/8 H 12.4	1/2 U 5.1
P031-5721	AV190ET047S7Y	22	7.5 x 7.5	57500	208/230	1	60	24.8	14.6	45/440	7/8 H 12.4	1/2 U 5.1
P031-6121	AG133ET001S7Y	22	7.5 x 7.5	60000	208/230	1	60	30.5	16.4	55/440	7/8 U 16.0	1/2 U 4.8
P031-0791	AK123JB009S7Y	22	BRKT	7500	265	1	60	2.6	9.5	15/370	3/8 U 9.4	1/4 U 6.7
P031-0992	AK145JB009A4	22	BRKT	9400	265	1	60	3.0	9.4	15/370	3/8 U 9.2	1/4 U 6.7
P031-1292	AK151JB009S7Y	22	BRKT	12000	265	1	60	4.2	9.0	15/370	3/8 U 8.9	1/4 U 6.2
P031-1591	AJ600JB120S7Y	22	4.8 x 8	15000	265	1	60	7.4	10.8	20/440	1/2 U 3.5	5/16 U 10.3
P031-1593	AK147JB009S7Y	22	BRKT	15000	265	1	60	5.4	9.4	15/440	3/8 U 9.2	1/4 U 6.5

HERMETIC COMPRESSORS - TECUMSEH RECIPS

Hermetic Recip R-22

Single Phase 208/230V, 265, 60HZ

Part Number	Mfg Number	Refrigerant	MTG ARR	Capacity	Voltage	Phase	Hz	RLA	Height	Run Cap	Suction	Discharge
P031-1791	AJ200JB206S7Y	22	4.8 x 8	17000	265	1	60	10.5	11.1	25/370	1/2 U	5/16 U
P031-1794	AW701JT094S7Y	22	7.5 x 7.5	17000	265	1	60	6.8	13.1	25/370	3/4 H 11.6	3/8 U 3.9
P031-1894	AW502JT089S7Y	22	7.5 x 7.5	18000	265	1	60	6.7	13.1	35/440	3/4 H 11.6	3/8 U 3.9
P031-1991	AJ220JB206S7Y	22	4.8 x 8	19000	265	1	60	12.0	11.4	25/440	1/2 U 11.1	5/16 U 4.1
P031-1993	AW702JT093S7Y	22	7.5 x 7.5	19100	265	1	60	7.5	13.1	25/370	3/4 H 12.6	3/8 U 3.9
P031-2191	AW504JT089S7Y	22	7.5 x 7.5	21800	265	1	60	7.8	13.1	35/370	3/4 H 11.6	3/8 U 3.9
P031-2492	AW705JT103S7Y	22	7.5 x 7.5	24700	265	1	60	9.2	13.1	35/440	5/8 AU 12.6	3/8 U 3.9
P031-2892	AW507JT089S7Y	22	7.5 x 7.5	28400	265	1	60	10.5	13.1	35/370	3/4 H 11.6	3/8 U 3.9

HERMETIC COMPRESSORS - TECUMSEH RECIPS

Hermetic Recip R-22

3 Phase 208/230V, 460, 575, 60HZ



Features:

- Low Noise & Vibration levels
- Adaptable to limited cabinet space
- External line break overload
- For Heat Pump & Air Conditioning duty
- Compact & lightweight

Hermetic Compressors

Part Number	Mfg Number	Refrigerant	MTG ARR	Capacity	Voltage	Phase	Hz	RLA	Height	Run Cap	Suction	Discharge
P031-2854	AW507RT098S7Y	22	7.5 x 7.5	28000	208/230	3	60	7.6	13.1	N/A	3/4 H 11.6	3/8 U 3.9
P031-3153	AW509RT098S7Y	22	7.5 x 7.5	31500	208/230	3	60	8.6	13.1	N/A	3/4 H 11.6	3/8 U 3.9
P031-3552	AV125RT046S7Y	22	7.5 x 7.5	34500	208/230	3	60	9.2	14.6	N/A	7/8 H 12.4	1/2 U 5.1
P031-3551	AV5535E	22	7.5 x 7.5	34600	208/230	3	60	9.7	14.0	N/A	7/8 H 11.7	1/2 U 5.1
P031-3854	AV134RT012S7Y	22	7.5 x 7.5	37750	208/230	3	60	10.8	14.6	N/A	7/8 U 13.7	1/2 U 5.1
P031-4151	AV147RT041S7Y	22	7.5 x 7.5	41500	208/230	3	60	11.3	14.6	N/A	7/8 H 12.4	1/2 U 5.1
P031-4251	AV145RT012S7Y	22	7.5 x 7.5	42500	208/230	3	60	12.0	14.6	N/A	7/8 U 13.8	1/2 U 5.1
P031-4652	AV169RT012S7Y	22	7.5 x 7.5	46000	208/230	3	60	13.3	14.6	N/A	7/8 U 13.8	1/2 U 5.1
P031-4951	AV178RT041S7Y	22	7.5 x 7.5	48500	208/230	3	60	13.5	14.6	N/A	7/8 H 12.4	1/2 U 5.1
P031-5351	AG122RT003S7Y	22	7.5 x 7.5	53000	208/230	3	60	15.5	16.1	N/A	7/8 U 15.3	1/2 U 4.5
P031-5751	AV190RT045S7Y	22	7.5 x 7.5	57000	208/230	3	60	15.7	14.6	N/A	7/8 H 12.4	1/2 U 5.1
P031-6151	AG133RT003S7Y	22	7.5 x 7.5	60000	208/230	3	60	18.0	15.9	N/A	7/8 U 15.5	1/2 U 4.8
P031-6851	AG144RT001S7Y	22	7.5 x 7.5	68000	208/230	3	60	20.2	16.7	N/A	7/8 U 16.2	1/2 U 4.8
P031-2171	AW504TT091S7Y	22	7.5 x 7.5	21300	460	3	60	2.9	13.1	N/A	3/4 H 11.6	3/8 U 3.9
P031-2872	AW507TT091S7Y	22	7.5 x 7.5	28000	460	3	60	3.8	13.1	N/A	3/4 H 11.6	3/8 U 3.9
P031-3272	AV114TT017S7Y	22	7.5 x 7.5	31460	460	3	60	4.4	14.6	N/A	3/4 U 13.6	3/8 U 5.1
P031-3174	AW509TT090S7Y	22	7.5 x 7.5	31500	460	3	60	4.3	13.1	N/A	3/4 H 11.6	3/8 U 3.9
P031-3471	AV125TT043S7Y	22	7.5 x 7.5	34500	460	3	60	4.6	14.6	N/A	7/8 H 12.4	1/2 U 5.1
P031-3873	AV134TT036S7Y	22	7.5 x 7.5	38400	460	3	60	5.3	14.6	N/A	7/8 H 11.9	1/2 U 5.1
P031-4171	AV147TT043S7Y	22	7.5 x 7.5	41500	460	3	60	5.7	14.6	N/A	7/8 H 12.4	1/2 U 5.1
P031-4271	AV145TT013S7Y	22	7.5 x 7.5	41560	460	3	60	5.9	14.6	N/A	7/8 U 13.8	1/2 U 5.1
P031-4672	AV169TT013S7Y	22	7.5 x 7.5	46000	460	3	60	10.9	14.6	N/A	7/8 U 13.8	1/2 U 5.1
P031-4873	AV178TT043S7Y	22	7.5 x 7.5	48000	460	3	60	6.7	14.6	N/A	7/8 H 12.4	1/2 U 5.1
P031-5371	AG122UT003S7Y	22	7.5 x 7.5	53000	460	3	60	7.8	16.1	N/A	7/8 U 15.3	1/2 U 4.5
P031-5771	AV190TT045S7Y	22	7.5 x 7.5	57000	460	3	60	7.8	14.6	N/A	7/8 H 12.4	1/2 U 5.1
P031-6171	AG133UT003S7Y	22	7.5 x 7.5	60000	460	3	60	9.5	15.9	N/A	7/8 U 15.5	1/2 U 4.8
P031-6871	AG144UT001S7Y	22	7.5 x 7.5	68000	460	3	60	10.6	16.4	N/A	7/8 U 16.0	1/2 U 4.5
P031-7171	AG188UT001S7Y	22	7.5 x 7.5	71280	460	3	60	11.8	16.3	N/A	7/8 U 15.8	1/2 U 4.7
P031-3481	AV125VT043S7Y	22	7.5 x 7.5	34500	575	3	60	4.0	14.6	N/A	7/8 H 12.4	1/2 U 5.1
P031-4181	AV147VT043S7Y	22	7.5 x 7.5	41500	575	3	60	4.4	14.6	N/A	7/8 H 12.4	1/2 U 5.1
P031-4981	AV178VT043S7Y	22	7.5 x 7.5	48800	575	3	60	5.4	14.6	N/A	7/8 H 12.4	1/2 U 5.1
P031-5381	AG122VT004S7Y	22	7.5 x 7.5	51100	575	3	60	6.0	16.1	N/A	7/8 U 15.3	1/2 U 5.1
P031-5781	AV190VT045S7Y	22	7.5 x 7.5	57000	575	3	60	6.3	14.6	N/A	7/8 H 12.4	1/2 U 5.1
P031-6181	AG133VT003S7Y	22	7.5 x 7.5	59200	575	3	60	7.0	15.9	N/A	7/8 U 15.6	1/2 U 5.4

HERMETIC COMPRESSORS - LG/GOLDSTAR ROTARY

Rotary R22 Compressors

Single Phase 208/230V, 265, 60HZ



Features:

- Low Noise & Vibration levels
- Adaptable to limited cabinet space
- High efficiency
- For small size air conditioners
- Compact & lightweight

Part Number	Mfg Number	Refrigerant	MTG ARR	Capacity	Voltage	Phase	Hz	Height	Run Cap	Suction	Discharge
P030-0721	QA104KAD	22	P	7260	208/230	1	60	10.9	20/370	3/8 U 10.7	5/16 U 10.6
P030-0922	QK141KBM	22		9800	208/230	1	60	11.2	30/370	1/2 U	5/16 U
P030-1123	QK164KBD	22		11500	208/230	1	60	10.9	30/370	1/2 U	5/16 U
P030-1222	QK173KAH	22	P	12400	208/230	1	60	11.0	25/370	3/8 U 11.0	5/16 U 10.8
P030-1291	QK173QAA	22	P	12000	265	1	60	11.1	20/440	3/8 U 11.0	5/16 U 10.8

HERMETIC COMPRESSORS - HITACHI ROTARY

Rotary R22 Compressors

Single Phase 115V, 208/230V, 60HZ



Features:

- Low Noise & Vibration levels
- Adaptable to limited cabinet space
- High efficiency
- For small size air conditioners
- Compact & lightweight

Part Number	Mfg Number	Refrigerant	MTG ARR	Capacity	Voltage	Phase	Hz	Height	Run Cap	Suction	Discharge
P038-0901	SD134SW-H6AU	22	P	9605	115	1	60	11.1	55/250	3/8 U	5/16 U
P038-1121	SG673PB1-A	22		11945	208/230	1	60	11.7	35/400	3/8 U	5/16 U
P038-1721	SL253SN-C7EU	22		17700	208/230	1	60	12.3	50/400	1/2 U	3/8 U

HERMETIC COMPRESSORS - MATSUSHITA/PANASONIC ROTARY

Rotary R22 Compressors

Single Phase 115V, 208/230V, 265, 60HZ



Features:

- Low Noise & Vibration levels
- Excellent reliability
- High efficiency
- For Heat Pump & Air Conditioning duty
- Compact & lightweight

Part Number	Mfg Number	Refrigerant	MTG ARR	Capacity	Voltage	Phase	Hz	Height	Run Cap	Suction	Discharge
P034-0503	2R8S126A-6H	22	P	5600	115	1	60	9.9	35/370	3/8 U 8.4	1/4 U 9.6
P034-0605	2R10S126A-6G	22	P	6670	115	1	60	10.0	35/370	3/8 U 8.4	5/16 U 9.8
P034-0705	2R11S3R126A-6A	22	P	7160	115	1	60	10.6	35/370	3/8 U 8.4	1/4 U 10.6
P034-0706	2R11U126A-6B	22		7280	115	1	60	0	35/230		
P034-1302	SC-52171362-A	22		13710	115	1	60	12.7	50/250	5/8 U 12.8	3/8 U 12.7
P034-0622	2R10S236A6E	22		6538	208/230	1	60	10.8	15/370	3/8 U 10.8	1/4 U 10.5
P034-0821	SC-51171335-AG-01	22		8553	208/230	1	60	9	15/370	3/8 U 10.8	1/4 U 10.7
P034-1021	2P15S236A-10	22	S	10140	208/230	1	60	11.7	30/370	3/8 U 11.0	5/16 U 11.4
P034-1222	2P18S236-1A	22	S	12400	208/230	1	60	11.8	30/370	1/2 U 11.0	5/16 U 11.5
P034-1522	2K21S236A6C	22		15092	208/230	1	60	12.5	35/370	1/2 U 11.6	3/8 U 12.5
P034-2621	2J36C3R236A -1B	22	S	26310	208/230	1	60	13.1	35/370	5/8 U 12.6	3/8 U 13.1
P034-2921	2J39C3R236A-1E	22	U	29400	208/230	1	60	14.3	50/370	5/8 U 13.3	3/8 U 14.3
P034-0891	2R13S3R276A-6A	22		8550	265	1	60	8.7	15/400		
P034-0893	2R13S276A6B	22		8550	265	1	60	10.5	15/400	3/8 U 10.5	1/4 U 10.4
P034-1191	2P17S276A1C	22		11350	265	1	60	12.3	25/400	1/2 U 10.6	5/16 U 11.5
P034-1491	2K21T276AUD	22	P	14520	265	1	60	0	35/440	1/2 U	3/8 U

HERMETIC COMPRESSORS - TECUMSEH ROTARY

Rotary R22 Compressors

Single Phase 115V, 208/230V, 265, 60HZ



Features:

- Low Noise & Vibration levels
- Adaptable to limited cabinet space
- High efficiency
- For Heat Pump & Air Conditioning duty
- Compact & lightweight

Part Number	Mfg Number	Refrigerant	MTG ARR	Capacity	Voltage	Phase	Hz	RLA	Height	Run Cap	Suction	Discharge
P031-1004	RK136AT002S7Y	22	S	10300	115	1	60	8.6	10.5	25/370	1/2 U 8.6	3/8 U 10.0
P031-1103	RK147AT002S7Y	22	S	11700	115	1	60	9.4	11.6	25/370	1/2 U 8.8	5/16 U 11.0
P031-1301	RK157AT010S7Y	22	S	13200	115	1	60	11.4	11.4	25/370	1/2 U 9.1	5/16 U 11.3
P031-0921	RK124ET001T7Y	22	S	9100	208/230	1	60	3.8	11.2	25/370	1/2 U 9.3	5/16 U 10.6
P031-1124	HG191ET001S7Y	22	BRKT	11500	208/230	1	60	5.5	5.8	20/440	1/2 H	5/16 H
P031-1122	RK147ET002S7Y	22	S	11700	208/230	1	60	4.4	11.3	25/370	1/2 H 8.5	5/16 H 10.
P031-1323	RK157ET002T7Y	22	S	13200	208/230	1	60	5.4	11.7	25/370	1/2 U 8.9	5/16 U 10.5
P031-1523	RK222ET009S7Y	22	S	15500	208/230	1	60	6.4	11.9	25/370	5/8 U 9.2	5/16 U 11.3
P031-1825	RK233ET009S7Y	22	S	17700	208/230	1	60	7.6	11.8	25/370	5/8 U 9.2	5/16 U 11.3
P031-0991	RK124JB001T7Y	22	S	9100	265	1	60	3.3	11.2	25/370	1/2 U 9.2	5/16 U 10.5
P031-1191	RK147JB002A4	22	S	11700	265	1	60	4.5	11.7	25/440	1/2 U	5/16 U
P031-1391	RK157JB010S7Y	22	S	13200	265	1	60	4.8	11.5	25/440	1/2 U 8.8	5/16 U 10.9
P031-1594	RK222JB009S7Y	22	S	15500	265	1	60	5.4	12.3	25/440	5/8 U 9.6	5/16 U 11.7
P031-1793	RK233JB009S7Y	22	S	17500	265	1	60	6.3	12.3	25/440	5/8 U 9.6	5/16 U 11.7

HERMETIC COMPRESSORS - TOSHIBA ROTARY

Rotary R22 Compressors

Single Phase 208/230V, 265, 60HZ



Features:

- Low Noise & Vibration levels
- High quality & reliability
- High efficiency
- For Heat Pump & Air Conditioning duty
- Compact & lightweight

Part Number	Mfg Number	Refrigerant	MTG ARR	Capacity	Voltage	Phase	Hz	Height	Run Cap	Suction	Discharge
P035-0924	PH135X1C-3DZDU2	22		9640	208/230	1	60	11.2	35/370		
P035-1122	PH160X1C-3DZDU	22		11507	208/230	1	60	11.0	35/370	3/8 U 9.9	5/16 U 11.2
P035-2522	PH250X3-3LU	22	S	25000	208/230	1	60	12.1	45/370	1/2 U 11.1	7/16 U 12.1
P035-0791	PRH68XA4-6K	22	P	6850	265	1	60	11.0	15/370	3/8 U 10.5	1/4 U 10.9
P035-0992	PRH88XA4-6K	22	P	9000	265	1	60	11.6	15/370	3/8 U 11.6	1/4 U 11.0

HERMETIC COMPRESSORS - TOSHIBA ROTARY

Rotary R410A Compressors

Single Phase 115V, 208/230V, 60HZ



Features:

- Low Noise & Vibration levels
- High quality & reliability
- High efficiency
- For Heat Pump & Air Conditioning duty
- Compact & lightweight

Part Number	Mfg Number	Refrigerant	MTG ARR	Capacity	Voltage	Phase	Hz	Height	Run Cap	Suction	Discharge
P035-0806	EA82X1C-1FZDU1	410A		8150	115	1	60	11.0	45/250	1/2 U 9.5	5/16 U 11.0
P035-1001	EA108X1C-1FZDU1	410A		10926	115	1	60	11.0	45/250	1/2 U 9.5	5/16 U 11.0
P035-1121	PA108X1C-3FZDU	410A		11011	208/230	1	60	11.0	35/370	1/2 U 9.6	5/16 U 10.9
P035-1521	PA150X2CS-3KUU	410A		15365	208/230	1	60	12.6	40/370	1/2 U 12.5	5/16 U 12.6
P035-2021	PA200X2CS-3MUU	410A	S	20145	208/230	1	60	13.5	50/370	5/8 U 13.4	3/8 U 13.5

HERMETIC COMPRESSOR ACCESSORIES

TotalTest Acid/Moisture Test Kits



TT1-001



TT1-002

A quick, convenient and reliable way to check for the presence of moisture or acid in refrigerant. Using the TotalTest[®] Instrument with the appropriate blue or yellow tube will provide an easy visual test if contaminant exists.

The "Blue Tube" Tests for Acid and Moisture in selected refrigerants:

- Acid Test for R-11, R-12, R-500, R-502, R-22, R407C, R410A, R134A
- Moisture Test for R-11, R-12, R-500, R-502, R-22

The "Yellow Tube" Tests for Moisture in R410A

TotalTest[®]Kit TT1-001

Kit Includes:

- One TotalTest Instrument
- Five Blue TotalTest test tubes
- One TotalTest Kit case

TotalTest[®]2Kit TT1-002

Kit Includes:

- One TotalTest Instrument
- Five blue TotalTest test tubes
- Five yellow TotalTest test tubes
- One TotalTest Kit case

Part Number	Part Name	Description
TT1-001	TotalTest [®] Kit	Acid and Moisture Test Kit (does not include moisture test for R410A)
TT1-002	TotalTest [®] 2 Kit	Acid and Moisture Test Kit (includes moisture test for R410A)

Replacement Test Tube Pack



TT2-001



TT2-002

Six canisters of 5 tubes (30 tubes total) to be used with TotalTest[®] tool provided in kits TT1-001 and TT1-002

Part Number	Part Name	Description
TT2-001	Blue Tubes	Six canisters of 5 Blue Tubes (30 total)
TT2-002	Yellow Tubes	Six canisters of 5 Yellow Tubes (30 total)

Stake On Compressor Repair Kits



Features:

- Precision brass cylinder
- Won't breakdown under heat like plastic
- Wires are permanently attached
- Stainless steel set screws
- Standard factory 600 volt 65 strand machine wire
- Set of three color coded wires
- Insulator included
- Application wrench included
- Guaranteed for the life of the compressor

Part Number	AWG	Application
TLC-3-12	12	1.5-3 Ton
TLC-3-10	10	3.0-5.0 Ton
TLC-3-8	8	5 Ton & up

Compressor Hook-up Lead Kit

Part Number	Tab Width in (mm)	Wire Range AWG (mm ²)	QTY/PKG
P298-LEADS-10	.250 (6.35)	10 (6.0)	3 – 8" Leads With Flags & Heat Shrinkable Butt Connectors

HERMETIC COMPRESSOR ACCESSORIES

Compressor Grommets

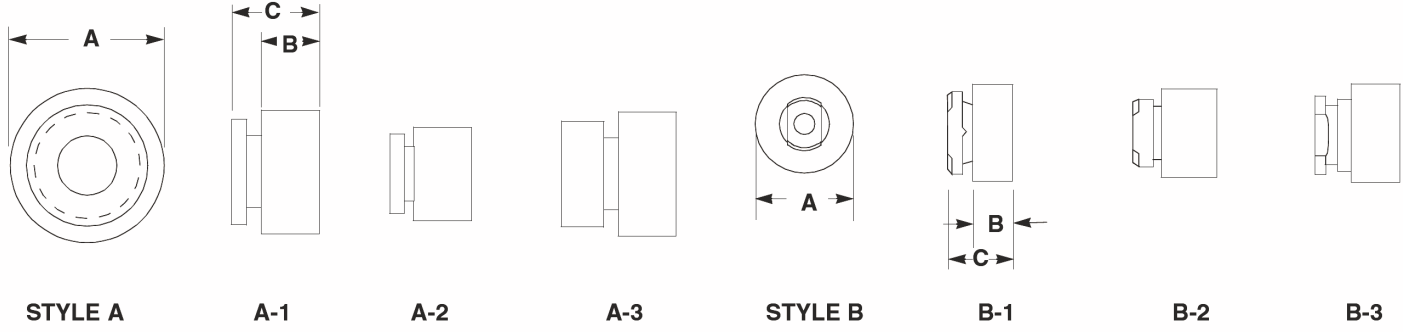

Part Number	Spec Number	'A' Grommet Diameter (in.)	Support Height (in.)		Style And Type	Durometer Hardness	Compressor Usage
			'B'	'C'			
P041-5101	KA56CR073	1.25	0.72	1.16	A-3	30-35	CAR-J COPE.
P041-5102	KA56CR078	1.25	0.72	1.16	B-2	45-50	COPE.
P041-5103	KA56CR079	1.625	0.75	1.16	B-1	35-45	COPE.
P041-5105	KA56TR017	1.25	0.593	0.906	A-1	37	TEC.-AJ, AH
P041-5107	KA56TR053	1.44	0.81	1.125	A-1	37	TEC.-AB, AH, AJ, AV, AW
P041-5108	KA56TR055	1.625	1.156	1.437	A-2	37	TEC.-AG
P041-5109	KA56TR060	1.625	0.84	1.434	B-3	37	TEC.-AK, RK

Tecumseh Mounting Grommet/Adaptor Packages

Compressor Usage	SPEC. NO.	P/N
Tecumseh AB, AH, AG Mounting grommet Pkg.	LP99	P041-5001
Tecumseh AJ Mounting grommet Pkg.	LP15	P041-5002*
Tecumseh CL/AG Mounting grommet Pkg.	LP29	P041-5003

Compressor Mounting Pkg. Used to replace compressors with mounting configurations of: 8" x 4-13/16", 8" x 6-5/16" and 8" x 10- 1/4".

HOLE #	Description	Vendor No.	P/N
1	Holes for mounting P or 3 & 4 cylinder R compressors. (G - mount)	Lis. Mfg.	P041-4003
2	Holes for mounting 2 cylinder R compressors (F - mount)		
3	Holes for "B" mount compressors. 8" x 4-13/16"		
4	Holes standard "A" mount. 7-1/2" x 7-1/2"		

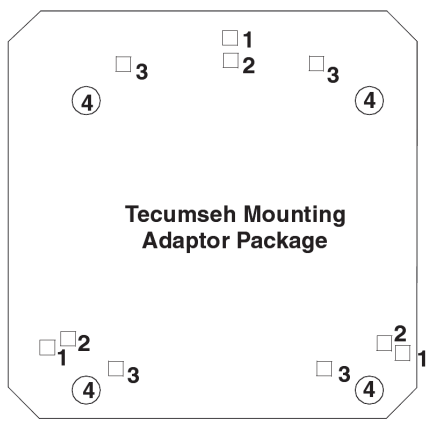

Adaptor Kit Contents

Quantity	Description	Works on:
8	Grommets	B to A F to A G to A (Refer to mounting guide)
8	Sleeves	
4	Carriage Bolts 5/16-18 x 1-3/4"	
4	Lock Washers	
4	Flat Washers 5/16" x 3/4"	
1	Instruction sheet	

Compressor Mounting Kit - 3 to 4 Bolt Adaptor Plate

Part Number	Description
06WP 660 002	Use When Replacing 3 Bolt Mounting Pattern with a 4 Bolt Pattern 7.5" x 7.5"

HERMETIC COMPRESSOR ACCESSORIES

Compressor Bolts

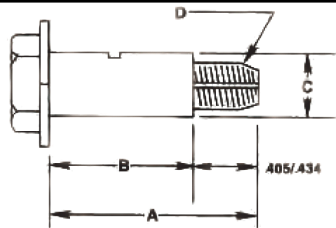

Part Number	Spec No	'A' (in)	'B' (in)	'C' OD (in)	'D' Thread (in)	Compressor Usage
AH 01AM 210	AH01AM210	1.55	1.125	0.436	5/16-18-D	--
P041-5309	AH01EM205	2	1.5	0.418	5/16-18-D	TEC.
P041-5310	AH01AM208	1.375	0.875	0.47	5/16-18-D	TEC. TOSHIBA

*All are packaged in quantities of (12).

Compressor Grommets Sleeve

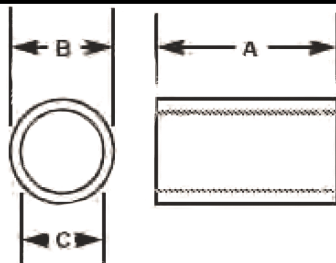

Part Number	Spec No	'A' (in)	'B' OD (in)	'C' OD (in)
P041-5201	KA56TS022	0.906	0.44	0.34

*All are packaged in quantities of (12).

Residential Mufflers 2 - 5 TON

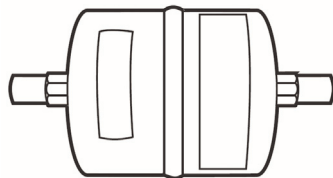

Part Number	Nom Ton Car	OD (in)	Inlet* Dim (in)
LM10KH001	2	2-5/16	3/8
LM10HK010	3	2-15/16	1/2
LM680001	5	3	1/2

*Inlet and outlet dimensions are specified as I.D. unless otherwise indicated.

**90° elbow in inlet.

•• Supersedes LM10HK001, 002.

Compressor Terminal Connector



- Quick connect designed to fit Hermetic compressor terminal

Part Number	Description
HY61AM094	Compressor Terminal Connector

Single Function Time Guard

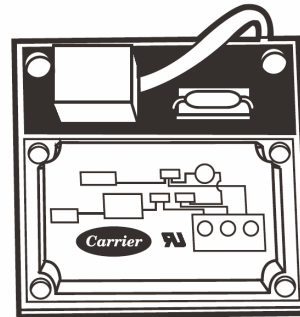

Size: 3.4H x 3.4W x 1.7D

- Time guard II
- Solid state controlled recycle delay timer
- Operation: in the event of any power interruption, Time guard II provides a 5 min. delay which prevents rapid cycling of the compressor
- Wiring diagram is printed on time guard
- Operating volts: 24
- Load current @ 24v-1 amp
- Switching arrangement: SPST-N.O.

Part Number	Description
HN67PA024	Single Function Time Guard

Discharge Thermostat Kit

Copeland "ZR" scroll compressors

Kit contains:
Thermostat, top case,
Ring and silicone sealer

Part Number	Description
571-0044-00	Discharge Thermostat Kit

HERMETIC COMPRESSOR ACCESSORIES

Crankcase Heaters

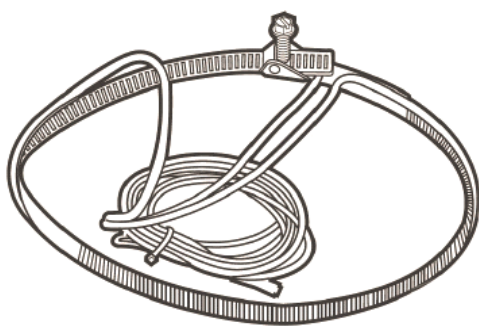

- Wrap around style...conforms to hermetic compressor shape

Part Number	Outlet Dim (in)	Watts (Hot)	Max Volts	Lead Length (In)
P041-4411	--	40	120	A
P041-4412	--	40	120	B
P041-4422	TEC-AK	40	240	D
P041-4423	TEC-AJ/COPE-RR, SR	40	240	E
P041-4443**	CAR-SC,SR/COPE ZRK	40	240	D
P041-4424	CAR-J, W/COP-SR, HIT-RHC	40	240	H
P041-4441	COPE-RR, SR	40	460	E
P041-4442	CAR-J, W/COPE-SR, HIT-RHC	40	460	H
P041-4444**	CAR-SC, SR/COPE ZRK	40	460	D
HT32BH970	CARLYLE SC/SR75-94	70	120	7.25.
HT32BH857	CARLYLE SC/SR75-94	70	240	7.25.
HT32BH858	CARLYLE SC/SR75-94	70	480	7.25.
P041-4721	COPE-BR	70	240	F
P041-4741	COPE-BR	70	480	G
HT32BH859	COPE ZR94-144	90	240	9.15.
HT32BH860	COPE ZR94-144	90	480	9.15.
HT32BH852	COPE ZR16-19M3	70	240	11.14.
HT32BH853	COPE ZR16-19M3	70	480	11.14.
HT32BH950	MANEUROP SM	50	120	10.0.
HT32BH975	MANEUROP SM	75	120	12.45.
HT32BH600	CAR-J	40	277	A
HT32BH906	CAR-W	40	575	H
HT32BH907	CAR-J	40	575	H

*= Size A fits circumferences of 24-5/16 to 33-1/2.
 Size B fits circumferences of 30 to 39-3/8.
 Size D fits circumferences of 20 to 25.
 Size E fits circumferences of 23 to 35-1/4.
 Size F fits circumferences of 27-7/8 to 39.
 Size G fits circumferences of 28-3/8 to 37-1/2.
 Size H fits circumferences of 28-3/8 to 35
 **Fits both Copeland ZRK-16-72 size and Scroll Technologies 34-61 size compressors

Crankcase Heaters – PTC Insertion

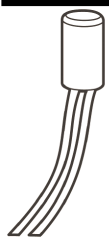

- PTC insertion style
- Use with heat sink compound

Part Number	Vendor Part No	Outlet Dim (in)	Watts	Volts	Lead Length
P041-4131	8HT5-507	TEC. AW	25-35	600	32

Heat Sink Compound

Part Number	Size	Description
38AQ680001	1/2 oz. Tube	Heat Sink Compound

HERMETIC COMPRESSOR ACCESSORIES

Compressor Soundshield

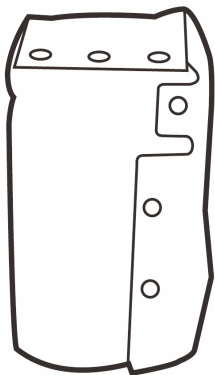

- Compressor sound shield provides sound level reduction
- Constructed of:

A. Acoustical polyurethane foam with vinyl covering

B. Polyethylene covered fiberglass

*Finished Goods Accessories.

@ Limited to stock qty. on hand.

Part Number	Comp Model Used On	Approximate Blanket Height (in)	CONST
38ES400384	BRISTOL H23A	14.8	A
314841-401	BRISTOL "H23, 2524"	16.25	B
320399-401	BRISTOL H-29	15	B
326830-401	BRISTOL T-89	17.4	B
310060-401 @	CARLYLE "J"	14.9	A
38UE500874 @	CARLYLE "M"	14	A
38UE500894	CARLYLE "P"	14	A
321538-401	CARLYLE "SC"	17.4	B
321538-402	CARLYLE "SR"	19.7	B
38EC500314	COPELAND "CR"	13	A
318415-401	COPELAND "CRK"	14.5	B
314840-401	COPELAND "CR-4"	14.5	B
312997-401	COPELAND "CR-5"	16	B
318414-401	COPELAND "CRK"	13.5	B
315997-401	COPELAND "CRL3"	14.5	B
38QB501484	COPELAND "RE"	11	A
38EC500344 @	COPELAND "YRD"	15	A
317035-401	COPELAND "ZR18-28"	14	B
317037-401	COPELAND "ZR34-42"	15	B
316739-401	COPELAND "ZR46-61"	21.4	B
38ED500404	TECUMSEH "AB"	10.62	A
312900-401 *	TECUMSEH "AB-AW"	13.92	A
38EC500334 @	TECUMSEH "AH, AJ"	13.75	A
38EC500564	TECUMSEH "AV"	14.92	A
314776-401 *	TECUMSEH "AV"	14.92	B
318416-401	TECUMSEH "AW"	13.92	B

Service Compressor Plugs

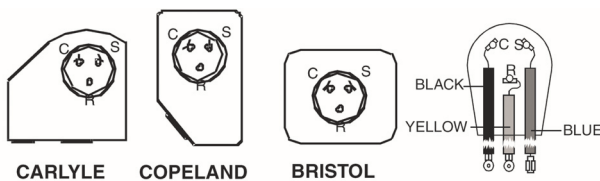

Part Number	Wire Gauge AWG	Wire Length		
		Black	Yellow	Blue
312906-413	10	44	44	44
312906-446	10	62	62	62
312906-426	10	92	92	85

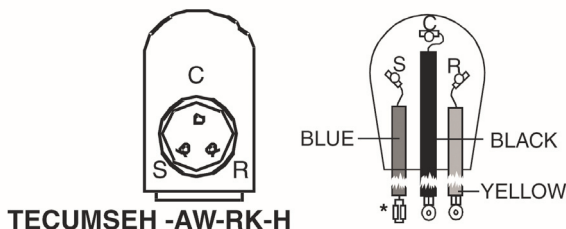

Part Number	Wire Gauge AWG	Wire Length		
		Black	Yellow	Blue
312906-411	14	38	38	50
312906-436	12	44	44	44
312906-422	14	80	80	72

HERMETIC COMPRESSOR ACCESSORIES

Service Compressor Plugs

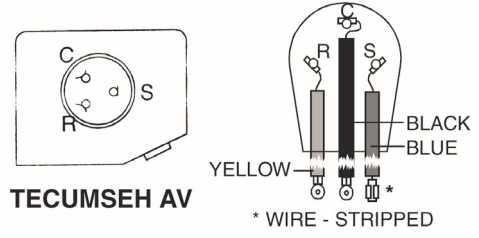

Part Number	Wire Gauge AWG	Wire Length		
		Black	Yellow	Blue
312906-435	10	38	38	38
312906-428	12	44	44	44
312906-434	14	44	44	56



Part Number	Wire Gauge AWG	Wire Length		
		Black	Yellow	Blue
317749-407	12	52	52	52
317749-415	10	44	44	44

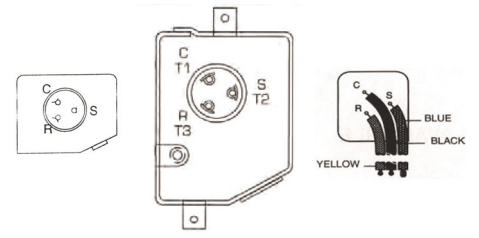

Part Number	Wire Gauge AWG	Wire Length		
		Black	Yellow	Blue
312906-452	(2)10 (1)14	54	54	54
312906-455	12	54	54	54

Compressor Plug Assembly

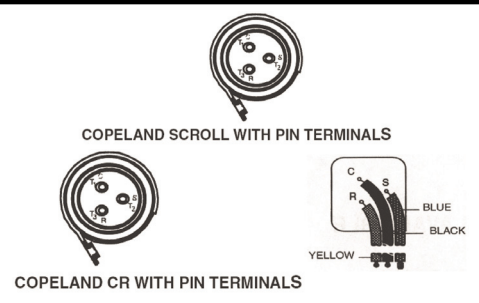

Part Number	Description
P298-001	For Copeland CR and Scroll Compressors with Pin Terminals