



CW2 Series

Wall Mounted Air Quality Sensors

Product Overview

The CW2 Series of air quality sensors for living space is a flexible multi-sensor platform for use with BAS controllers designed to accept 4 to 20mA, 0 to 5Vdc or 0 to 10Vdc outputs. CW2 Series sensors are available with three user interface options: touchscreen, LCD with three buttons and blank. CO2 and temperature sensors are included with all CW2 Series air quality sensors. Models with VOC sensors and relative humidity sensors are also available.



NOTICE

- This product is not intended for life or safety applications.
- Do not install this product in hazardous or classified locations.
- Read and understand the instructions before installing this product.
- Turn off all power supplying equipment before working on it.
- The installer is responsible for conformance to all applicable codes.

If this product is used in a manner not specified by the manufacturer, the protection provided by the product may be impaired. No responsibility is assumed by the manufacturer for any consequences arising out of the use of this material.

Product Identification

User Interface	Output	RH Accuracy ¹	Temperature	VOC Sensor
CW2 <input type="checkbox"/>	<input type="checkbox"/>	<input type="checkbox"/>	<input type="checkbox"/>	<input type="checkbox"/>
T = Color touchscreen L = 3-button LCD display X = None ²	A = Analog output	2 = 2% X = None ²	A = Transmitter C = 1000 PT RTD D = 10K T2 thermistor G = 10K CPC thermistor ³ H = 10K T3 thermistor K = 10K curve G/11K shunt M = 20K NTC thermistor N = 1.8K TAC thermistor	V = NDIR CO ₂ /VOC ⁴ = None

1. Replaceable 1% with NIST certificate, 2% with NIST certificate and 2% elements available.
2. For analog non-display, non-RH, models with RTD/thermistor order from CWE2 line.
3. Available in CW2LAXG only.
4. VOC only available with temperature transmitter option.

Specifications

OPERATING ENVIRONMENT	
Input Power	Class 2; 20 to 30 Vdc, 24 Vac, 50 to 60 Hz
Analog Output	Selectable 4 to 20 mA, 0 to 5 V, 0 to 10 V
Operating Temp. Range	0 to 50 °C (32 to 122 °F)
Operating Humidity Range	0 to 95% RH non-condensing
Housing Material	High-impact ABS plastic
Terminal Block Torque	0.5 to 0.6 N-m (0.37 to 0.44 in-lbf)
IP Rating	IP 30
CO ₂ TRANSMITTER	
Sensor Type	Non-dispersive infrared (NDIR), diffusion sampling
Output Range	0 to 2000/5000 ppm (selectable)
Accuracy	±30 ppm ±3% of measured value
Repeatability	±20 ppm ±1% of measured value
Response Time	<60 seconds for 90% step change
VOC TRANSMITTER OPTION	
Sensor Type	Solid state
Output Range	0 to 100% AQI for VOC
Accuracy	±15% of measured value
Output Scale	0 to 1,000 ppb of total VOC (TVOC)

Specifications (cont.)

	Level	Ventilation Recommendation	TVOC (ppb)
AQI Table*	>61%	Greatly increased	>610
	20 to 61%	Significantly increased	200 to 610
	10 to 20%	Slightly increased	100 to 200
	5 to 10%	Average	50 to 100
	0 to 5%	Target value	0 to 50
RH TRANSMITTER OPTION			
HS Sensor	Thin-film capacitive, replaceable		
Accuracy	±2% from 10 to 80% RH @ 25°C (77 °F)		
Hysteresis	1.5% typical		
Stability	±1% @ 20°C (68 °F) annually for 2 years		
Output Range	0 to 100% RH		
Temperature Coefficient	±0.1% RH/°C above or below 25 °C (77 °F) typical		
TEMPERATURE TRANSMITTER OPTION			
Sensor Type	Solid state, integrated circuit		
Accuracy	±0.2 °C (±0.4 °F) typical		
Resolution	0.1 °C (0.1 °F)		
Range	0 to 50 °C (32 to 122 °F)		
DISPLAY MODELS			
Touchscreen	61 mm (2.4 in), color, backlit, capacitive, 240x300 px Setpoint: 0-10Vdc. Temperature, humidity or fan speed selectable Timeout override: Display timeout** Lockout override: Touchscreen/button lockout**		
LCD	52mm (2.05 in), segmented with 3 buttons Setpoint: 0-10Vdc. Temperature, humidity or fan speed selectable Timeout override: Display timeout** Lockout override: Touchscreen/button lockout**		
SETPOINTS***			
Temperature Setpoint	0 to 10V output Scale: 10 to 35 °C (50 to 95 °F) / 0 to 50 °C (32 to 122 °F)		
Humidity Setpoint	0 to 10V output Scale: 0 to 100% RH		
Fan Speed Setpoint	0 to 10V output Off 0V, Auto 1.5V, Low 3.3V, Med. 6.7V, High 10.0V		
OVERRIDE			
Override Button	Display models feature a momentary-to-ground override button		
WIRING TERMINALS			
Terminal Blocks	Screw terminals, 18-24 AWG		
Screw Terminal Torque	0.2 N-m (2.0 in-lbF) max.		
WARRANTY			
Limited Warranty	5 years		
COMPLIANCE INFORMATION			
Agency Approvals	UL 916, European conformance CE: EN61000-6-2, EN61000-6-3, EN61000 Series - industrial immunity, EN 61326-1 FCC Part 15 Class B, REACH, RoHS, RCM (Australia), ICES-003 (Canada)		

* Air Quality Index for VOC aligns with TVOC levels for IAQ as specified by the WHO (World Health Organization).

**DIP switch selectable.

*** One setpoint type is selectable via DIP switch on display models only.

Dimensions

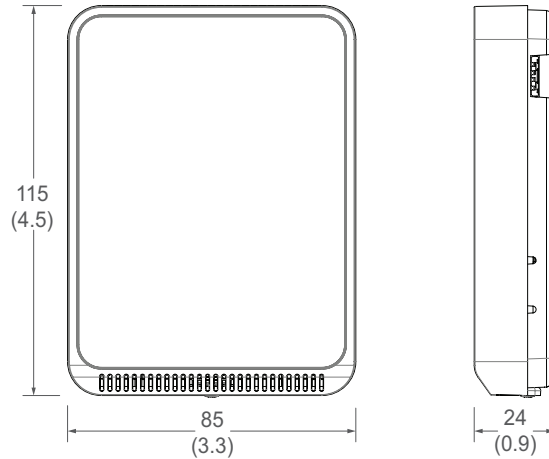

Functions

The CW2 Series sensor measures CO₂, VOC (if equipped), RH (if equipped) and temperature in a room and provides analog outputs to a controller.

Installation

1. Remove the cover from the base at the bottom of the device.



2. Position the sensor base vertically on the wall 1.35 m (4.5 ft.) above the floor with the “UP” arrow facing upward. Locate away from windows, vents and other sources of draft. If possible, do not mount on an external wall, as this may cause inaccurate temperature readings.



3. Pull 18 or 22 AWG cable(s) through the hole in the backplate.



Installation (cont.)

4. Mount the backplate onto the wall using the screws provided.

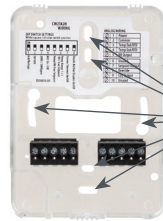

Six screw holes available. Use a minimum of two for secure mounting.

5. Connect the wires to the screw terminals. Do not over-tighten the screws.

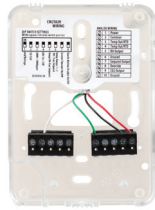

Wiring for models with temperature transmitter:

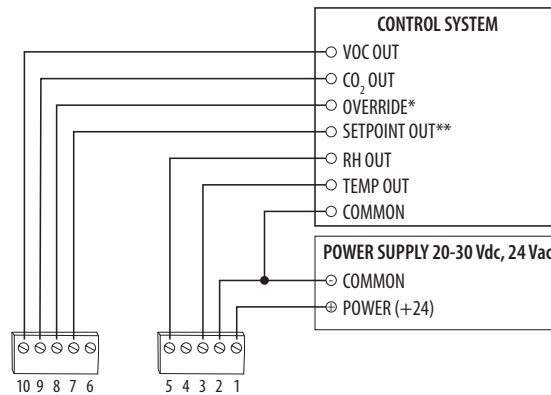

Wiring for models with RTD/thermistor:

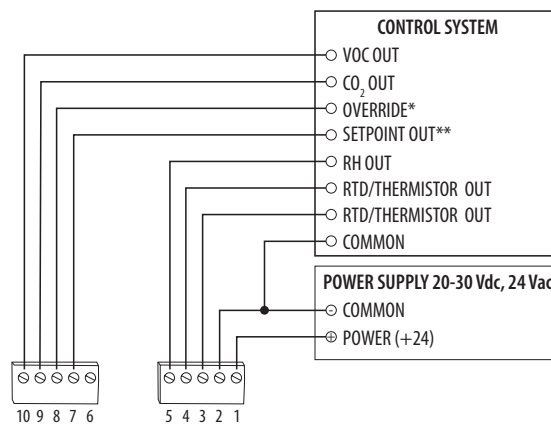

* Momentary to ground.

** 0-10V DIP switch selectable for temperature, RH (if equipped) or fan speed (off, 0V, Auto 1.5V, Low 3.3V, Medium 6.7V or high 10V).

Installation (cont.)

6. Set the DIP switches.

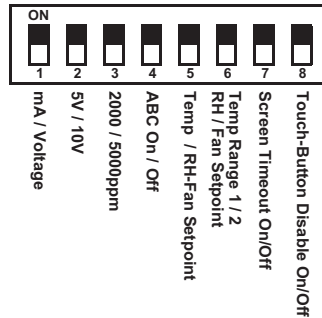

Switch	Function	Description
1	Output mode	ON - 4-20mA output mode enabled OFF - Voltage output mode enabled
2	Voltage output range*	ON - 0-5V output range enabled OFF - 0-10V output range enabled
3	CO ₂ output range	ON - 0-2000 ppm CO ₂ output range enabled OFF - 0-5000 ppm CO ₂ output range enabled
4	Automatic Baseline Calibration (ABC) for CO ₂	ON - ABC enabled OFF - ABC disabled
5	Setpoint output type	ON - Temperature setpoint enabled (temp range selected on DIP switch 6) OFF - RH or Fan Speed setpoint enabled (specific setpoint output type to be selected on DIP switch 6) Models without RH option select only temp or fan setpoint
6	Setpoint output temperature range or RH/Fan Speed output type	Temperature setpoint (must be enabled on DIP switch 5) ON - Temp range 1, 50 to 95 °F (10 to 35 °C) enabled OFF - Temp range 2, 32 to 122 °F (0 to 50 °C) enabled
		RH or Fan Speed setpoint (must be enabled on DIP switch 5) ON - RH setpoint enabled OFF - Fan Speed setpoint enabled Models without RH option, set to OFF
7	Display times out and turns off after 6-10 seconds of touchscreen/button press	ON - Display Timeout enabled OFF - Display Timeout disabled
8	Touchscreen touch functions and buttons are disabled	ON - Touchscreen touch/button functions disabled OFF - Touchscreen touch/button functions enabled

* Only used with voltage output mode enabled. Not applicable to setpoint output. Setpoint is 0-10V fixed.

7. With sensor base fully installed, align top of cover to mounting tabs on top of sensor base. Swing cover downward until it latches at the bottom.



Installation (cont.)

8. Install locking screw to secure cover in closed position.



9. 400 ppm baseline calibration allows the sensor to be set at 400 ppm. Push and hold the calibrator button for 3 to 5 seconds. The LED will flash green. Once the pushbutton is released, the calibration is complete and the LED is switched off.

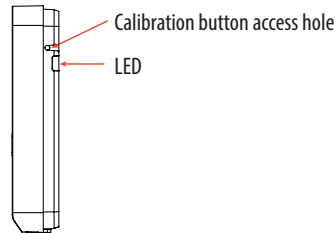

Touchscreen Operation

Main Screen

The touchscreen user interface displays applicable sensor output values (temperature, RH, CO₂ and VOC), setpoint value, menu button and CO₂ stoplight status (if enabled).

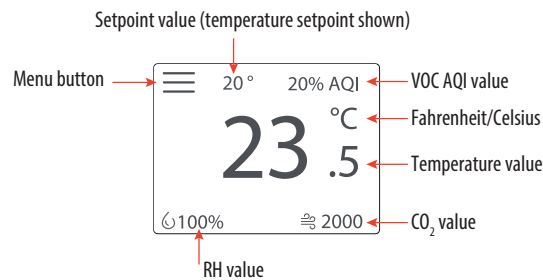

Menu Screen

The menu screen opens when pressing the Menu button on the main screen. Integrator's submenu, occupancy/override, Fahrenheit/Celsius, settings, setpoint submenu (temp, RH or fan, determined by DIP switch settings) and CO₂ stoplight buttons are displayed on the menu screen.



Temperature setpoint
DIP switch selected

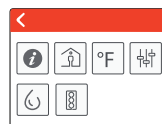

RH setpoint
DIP switch selected

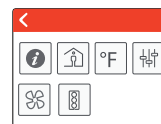

Fan Speed setpoint
DIP switch selected



Menu Button Functions



 **Integrator's Submenu**
Press this icon to access the Integrator's menu.

Submenu Only

Model	CW2TA2AV
Serial #	4E54F3B5
Date code	2020
Rev code	01A

Touchscreen Operation (cont.) *Menu Button Functions (cont.)*

- 
Occupied Override Button
 Press this icon to provide momentary ground output to the controller.
 Single Press Only
 Signals occupied/override call to controller.

- 
Fahrenheit/Celsius Switch
 Press this icon to display either °C or °F.
 Single Press Only
 Changes units to Fahrenheit when pressed.
 Changes units to Celsius when pressed.

 **Settings**
This icon provides the ability to change the color scheme of the display.

Submenu Only

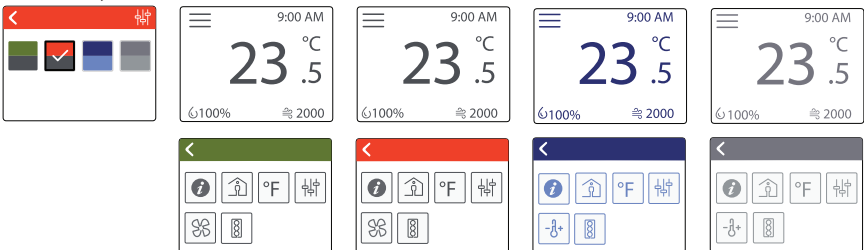

 **Temp Setpoint Adjustment**
Click this icon to access the setpoint change menu. Mutually exclusive with fan speed, set by DIP switch.

Submenu Only

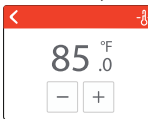

 **Humidity Setpoint Adjustment**
Click this icon to access the setpoint change menu. Mutually exclusive with humidity and fan speed. Set by DIP switch.

Submenu Only

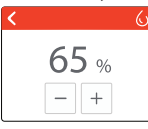

 **Fan Speed**
Click this icon to access the fan speed menu. Mutually exclusive with humidity and fan speed. Set by DIP switch.

Submenu Only

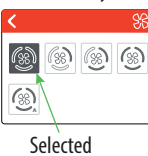

Touchscreen Operation (cont.)

CO₂ Stoplight Menu
 Click this icon to toggle the CO₂ Stoplight feature on and off. With CO₂ Stoplight turned on, the background color of the main screen changes with CO₂ level. This provides a visual indicator of CO₂ levels to the room occupants.

Using the +/- buttons, the thresholds at which the colors change on the main screen are user configurable, as described in the diagram.

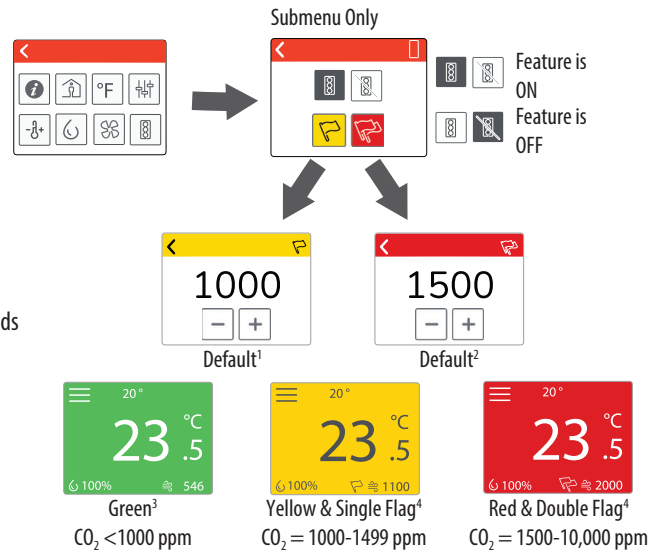

1. Values <400 ppm will be rounded up to the minimum limit of 400 ppm.
2. Values >10,000 ppm will be rounded down to the maximum limit of 10,000 ppm.
3. Possible to adjust CO₂ thresholds by changing the yellow and red limits.
4. User configurable in increments of 10 ppm using the +/- buttons. With a long press of these buttons, the number will change more quickly.

LCD Display Operation

Button Functions

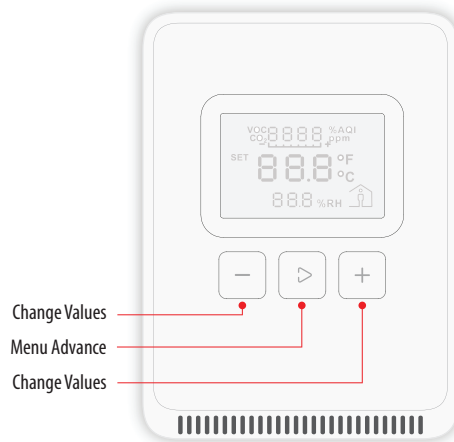

Display Icons

The main screen displays sensor values for CO₂, VOC (if equipped), RH (if equipped), temperature and Celsius/Fahrenheit.

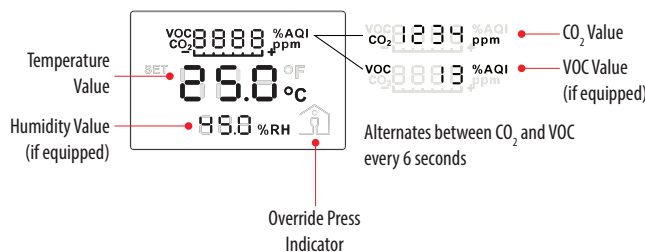

Setpoint Function

A single 0-10V setpoint (temperature, RH (if equipped) or fan speed) can be selected via DIP switch.

Temperature Setpoint Adjustment

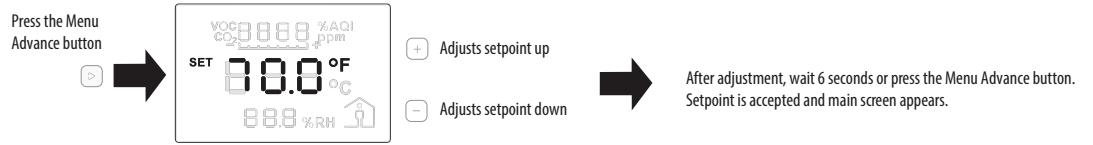

Note: Numeric information will flash while in Set mode.

RH Setpoint Adjustment

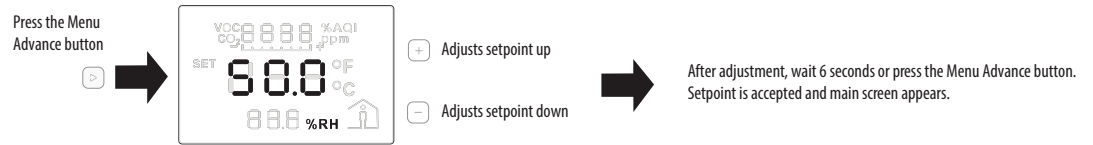

Note: Numeric information will flash while in Set mode.

Fan Speed Setpoint Adjustment

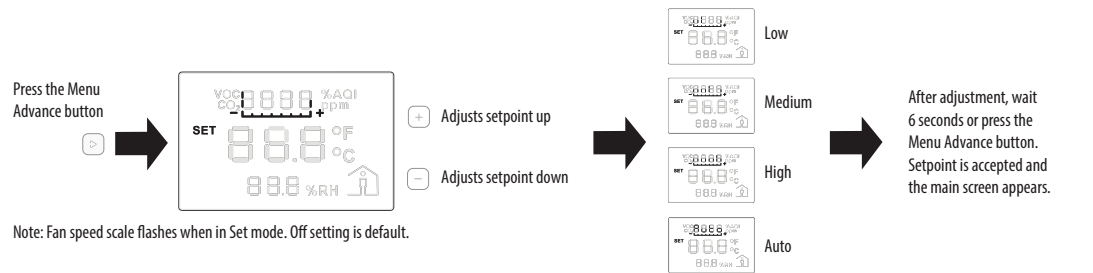

Note: Fan speed scale flashes when in Set mode. Off setting is default.

Changing Celsius and Fahrenheit Scales

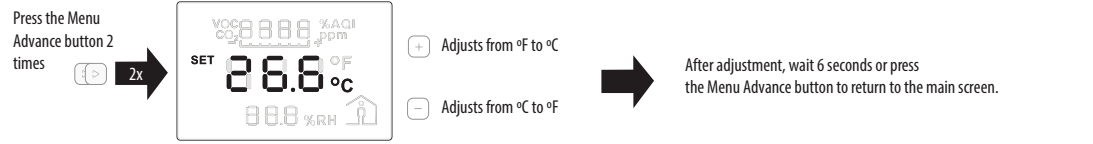

Note: °F or °C text will flash while in Set mode.

Occupied/Override Button

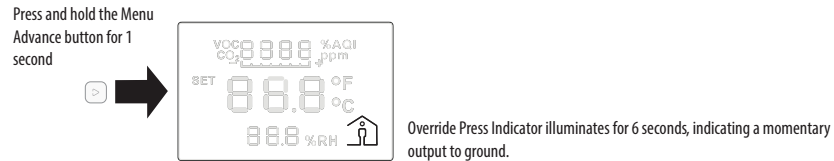

China RoHS Compliance Information

Environment-Friendly Use Period (EFUP) Table

部件名称	有害物质 - Hazardous Substances					
Part Name	铅 (Pb)	汞 (Hg)	镉 (Cd)	六价铬 (Cr (VI))	多溴联苯 (PBB)	多溴二苯醚 (PBDE)
电子件 Electronic	X	O	O	O	O	O

本表格依据SJ/T11364的规定编制。

O: 表示该有害物质在该部件所有均质材料中的含量均在GB/T 26572规定的限量要求以下。

X: 表示该有害物质至少在该部件的某一均质材料中的含量超出GB/T 26572规定的限量要求。

(企业可在此处，根据实际情况对上表中打“X”的技术原因进行进一步说明。)

This table is made according to SJ/T 11364.

O: indicates that the concentration of hazardous substance in all of the homogeneous materials for this part is below the limit as stipulated in GB/T 26572.

X: indicates that concentration of hazardous substance in at least one of the homogeneous materials used for this part is above the limit as stipulated in GB/T 26572

Z000057-0B