

H721LC



Hawkeye® 721LC

Solid-Core Current Transducer, 4-20mA Output

Installer's Specifications

| | |
|----------------------------------|---|
| Amperage Range | 0-10/20/40 Amps (slide switch selectable) |
| Sensor Power | 30mA (max)@12-30VDC |
| Insulation Class | 600VAC RMS (UL), 300VAC RMS (CE) |
| Frequency | 50/60Hz |
| Temperature Range | -15° to 60°C (5° to 140°F) |
| Humidity Range | 10-90% RH, non-condensing |
| Accuracy | ±2%FS from 10% - 100% of selected range, but not less than ±0.4A |
| Response Time | 2 sec. |
| Terminal Block Maximum Wire Size | 14 AWG |
| Terminal Block Torque (nominal) | 4 in-lbs (0.45 N-m) |
| Agency Approvals | UL 508 open device listing CE: EN61010-1:2001-2, CAT III, deg. 2, basic insulation |

DANGER

HAZARD OF ELECTRIC SHOCK, EXPLOSION, OR ARC FLASH

- Follow safe electrical work practices. See NFPA 70E in the USA, or applicable local codes.
- This equipment must only be installed and serviced by qualified electrical personnel.
- Read, understand and follow the instructions before installing this product.
- Turn off all power supplying equipment before working on or inside the equipment.
- Use a properly rated voltage sensing device to confirm power is off.
DO NOT DEPEND ON THIS PRODUCT FOR VOLTAGE INDICATION
- Only install this product on insulated conductors.

Failure to follow these instructions will result in death or serious injury.

NOTICE

- This product is not intended for life or safety applications.
- Do not install this product in hazardous or classified locations.
- The installer is responsible for conformance to all applicable codes.
- Mount this product inside a suitable fire and electrical enclosure.

QUICK INSTALL

- Disconnect and lock out power.
- Install the mounting bracket to the back of the electrical enclosure, no closer than 1/2" (12mm) to an uninsulated conductor.
- Slide the conductor to be monitored through the sensing hole of the current switch. Terminate the conductor. See Notes (page 2) for currents under 1 Amp or above 40 Amp.
- Set the desired amperage range on the H721LC (10, 20, or 40 Amps).
- Wire the output connections between the H721LC and the controller (4-20mA).
- Reconnect power.
- Scale the controller software to match the H721LC's output.

DIMENSIONS

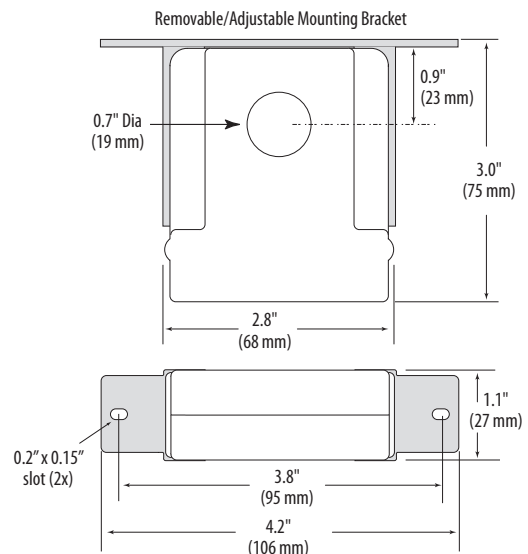

WIRING EXAMPLE

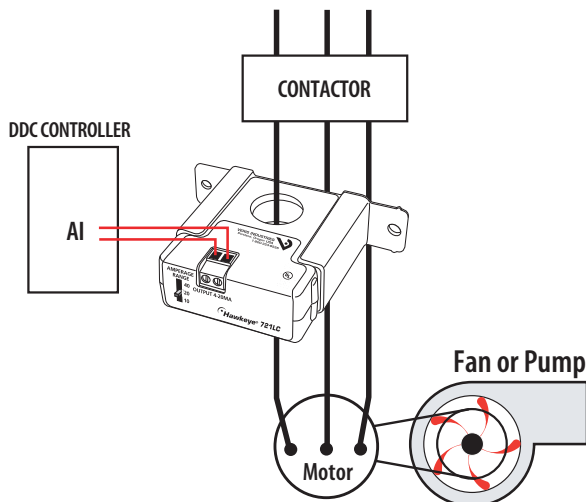

OPERATION

The H721LC is a current transducer that senses current (amperage) in any of three field-selectable ranges: 0-10, 0-20, or 0-40 amperes. These ranges represent the maximum current that can be applied to the monitored conductor. The H721LC transforms the monitored current into a 4-20mA output suitable for connection to building controllers or other appropriate data acquisition equipment. The H721LC requires 12-30VDC external power to generate its output.

NOTES

For load currents greater than sensor maximum rating:
Use a 5 Amp (H681x series) Current Transformer (CT) as shown.

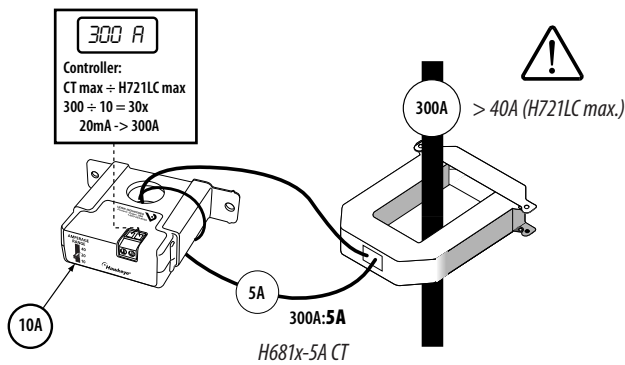

! DANGER: 5A CTs can present hazardous voltages. Install CTs in accordance with manufacturer's instructions. Terminate the CT secondary before applying current.

CAUTION

RISK OF EQUIPMENT DAMAGE

- Derate the product's maximum current for the number of turns through the sensing window using the following formula.

Rated Max. Amps ÷ Number of Turns = Max. monitored Amps
e.g. : 30A ÷ 4 Turns = 7.5 Amps max. in monitored conductor

Failure to follow these instructions can result in overheating and permanent equipment damage.

For load currents less than sensor minimum rating:
Wrap the monitored conductor through the center hole and around the sensor body to produce multiple turns through the "window." This increases the current measured by the transducer.

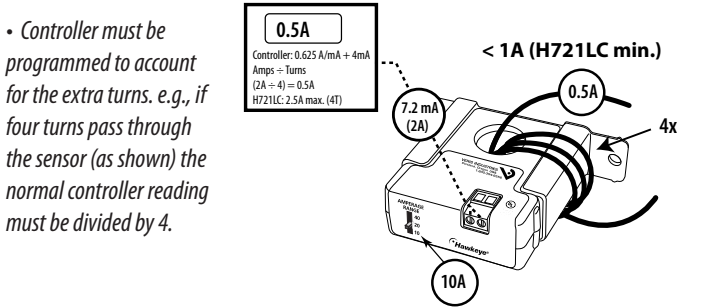

WIRING EXAMPLES

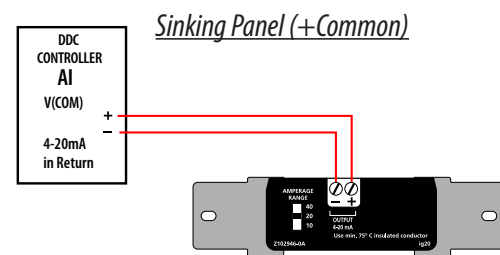
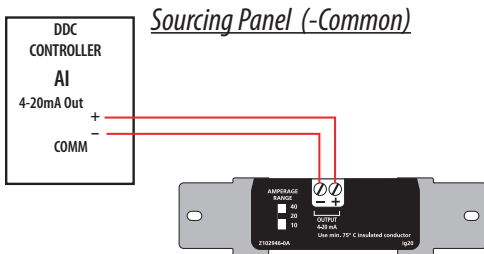
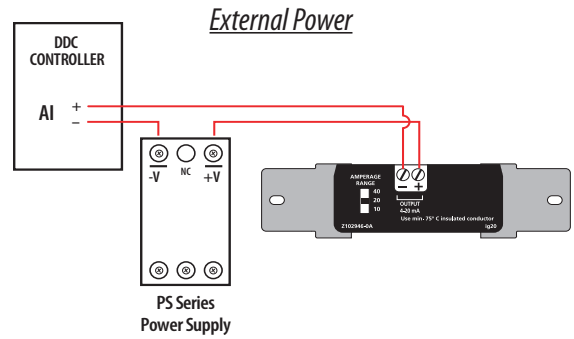

*A resistor can be added in parallel to convert the 4-20mA signal to a VDC signal (250 ohm = 1-5VDC); (500 ohm = 2-10VDC)

CALIBRATION/SCALING

Set the amperage range selector switch to a level appropriate for your load. The H721LC is available with three choices, 0-10, 0-20, or 0-40 Amps.

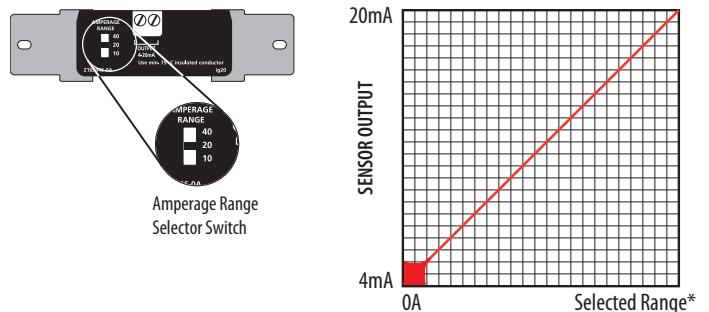

*Factory calibrated ranges selected with the amperage range switch

TROUBLESHOOTING

| Problem | Solution |
|--------------------------|--|
| No Reading at Controller | <ul style="list-style-type: none"> Confirm that you have 12-30VDC in series with the sensor output terminals and the control panel analog input. Confirm measured current is within the selected range on the product. Check polarity of sensor output connections. |