

Ranco V1-V12 4-Way Reversing Valves



APPLICATIONS

The RANCO 4-Way Reversing Valve, when installed in a heat pump system, reverses the direction of refrigerant flow through the heat exchanger coils to provide heating or cooling from the system and to provide for defrosting of the outdoor coil in air source units. It is designed for residential and commercial heat pumps (unitary and split systems), including air and water heat sources.

SPECIAL FEATURES

- Designed for minimal pressure drop to allow higher system efficiencies.
- 4-way pilot valve uses high and low side refrigerant pressure to push and pull the main valve slide for positive reversals at low pressure differentials.
- Hermetic construction using high quality materials (brass, copper, stainless steel) to eliminate external leakage for longer system life
- Teflon® lubricated sliding surfaces provide reduced internal friction and high contaminant resistance to provide longer valve durability and reliability (V4–V12).
- Low solenoid power consumption provides a Class B UL thermal rating for AC coils.
- Solenoid coils have 1/4 male quick connects and are color coded by voltage.
- Solenoid coils can be removed within the length of the valve body and can be shipped attached to the valve in a choice of 4 positions.
- Available W29 wiring harnesses are shipped separately.
- Wiring harnesses can be specified at various lengths, terminations, and identification.

Valve Specifications

Minimum/Maximum P to reverse	15/440 psi (V12 - 15/400 psi)
Maximum normal working pressure	680 psi (V12 - 500 psi)
Maximum abnormal pressure (fatigue)	833 psi (V1 - V10 only)
Minimum burst pressure	2500 psi
Maximum operating temperature	250° F
Maximum brazing temperature ¹	250° F
Maximum sound level ²	50dB
Maximum external leakage ³	0.1 ounce per year
Known compatible refrigerants	R12, R22, R134a, R500, R502, R410a, R407c, R404a
Minimum life	165,000 cycles
Mounting position	Any

¹ Measured on valve body at connection tube interface.

² A-scale, 0.0002 Dyne/cm² reference, 12" from valve, 40 dB or less background.

³ Leakage measured at 400 psig internal pressure.

- A - Straight
- B - Candycane
- C - Flare
- D - Candycane w/ Flare
- E - Offset w/Flare
- F - Offset Straight

Valve Selection Guide

Valve Type	Capacity, Tons Minimum to Nominal R22	Internal Leakage, cc/min	Tube Style	Standard Connections Tube Sizes Female I.D., Inches	
				Discharge	Suction, L,R
V1	0.4 to 1	400 to 2000	A, B	1/4", 5/16", 3/8",	3/8", 1/2"
V2	0.75 to 2	400 to 2000	A, B	1/4", 5/16", 3/8",	3/8", 1/2"
V2	1 to 2.5	400 to 2000	C, D	3/8", 1/2"	5/8"
V3	1 to 2.8 (3 on 3/4)	500 to 2000	E	3/8", 1/2"	5/8", 3/4"
V4	1 to 4	500 to 4000	A	1/2", 5/8", 3/4"	3/4", 7/8"
V6	1/ 5.5	500 to 4000	A	3/8", 1/2", 5/8", 3/4"	3/4", 7/8"
V10	3 to 8.5 (9.5 on 1/8)	800 to 6000	A	1/2", 5/8", 3/4", 7/8"	7/8", 1 1/8"
V12	5 to 12	1500 to 15000	F	1 1/8"	1 3/8"

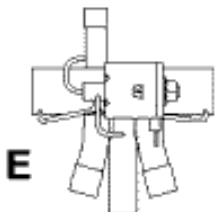
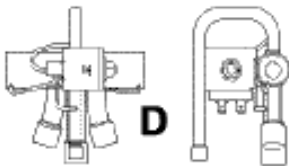
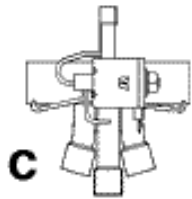
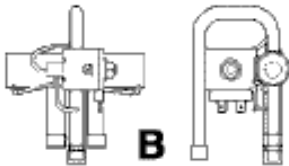
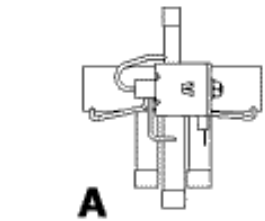

Minimum capacities shown are recommendations based on standard ARI conditions (45° F Evap. 130° F Cond., 10° F SH, 10° F SC, 64.8 Btu/lb. H) and reciprocating compressors. System manufacturers are encouraged to conduct their own application testing to assure positive valve reversals under all anticipated operating conditions.

Nominal Capacity shown at 2 psig suction pressure drop. Maximum capacity not shown; Suction pressure drop vs. valve type used must be rationalized.

Valves for systems using alternate compressor styles and/or high efficiency, large volume coils should be evaluated for proper sizing to ensure minimum valve pressure drop and capacity for reliable reversals.

Male O.D. tube sizes are also available.



Typical Valve Drawing (V2)

Front View Top View Side View

(Click on the above descriptions to view the drawing)

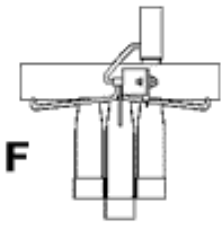

Suction Pressure Drop Chart (R22)

(Click on the above description to view the drawing)

L30 Solenoid Coil Specifications

Coil Type	Color	Voltage	Frequency	Wattage 50/60 Hz	VA 50/60 HZ	UL Thermal Class
L30 - 12	Red	24 VAC	50/60 Hz	6/4 W	11/8	B
L30 - 32	Black	120 VAC	50/60 Hz	6/4 W	10/8	B
L30 - 42	Green	208/240 VAC	50/60 Hz	6/4 W @240	12/9 @240	B
L30 - 52	Blue	277 VAC	50/60 Hz	5/4 W	10/8	B
L30 - 62	Black	480 VAC	50/60 Hz	5/4 W	10/8	B
L30 - H2	Orange	600 VAC	50/60 Hz	5/4 W	11/9	B
L30 - 73	Yellow	12 VDC	DC	8.5 W	9	F
L30 - 83	Orange	24 VDC	DC	8.5 W	9	F

Minimum / Maximum operating voltage are 85%/110% of rated voltage.

TYPICAL COIL DRAWING

(Dimensions in inches)

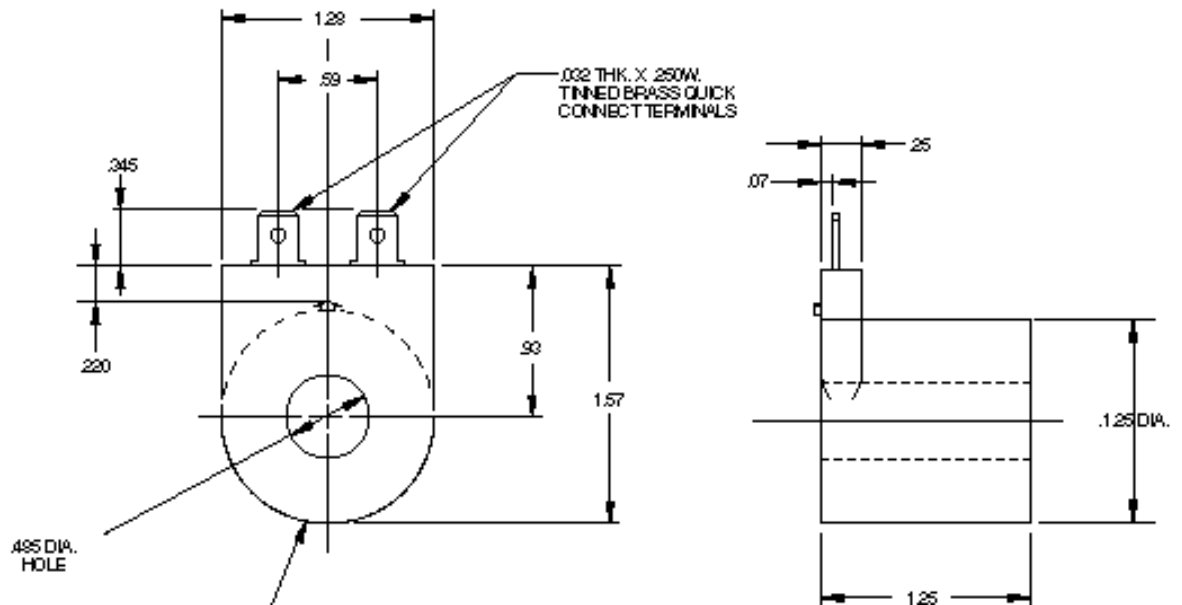

W29 Wiring Harness Features

- Two 18 GA wires insulated with 105°C rated PVC, rip cord style.
- Wires are terminated on coil end with 1/4" female terminals which are over molded with PVC to form a moisture/dust sealing boot for the coil/harness connection
- Custom wire lengths, terminations and markings are available to meet system needs.

TYPICAL WIRING HARNESS DRAWING

(Dimensions in inches)

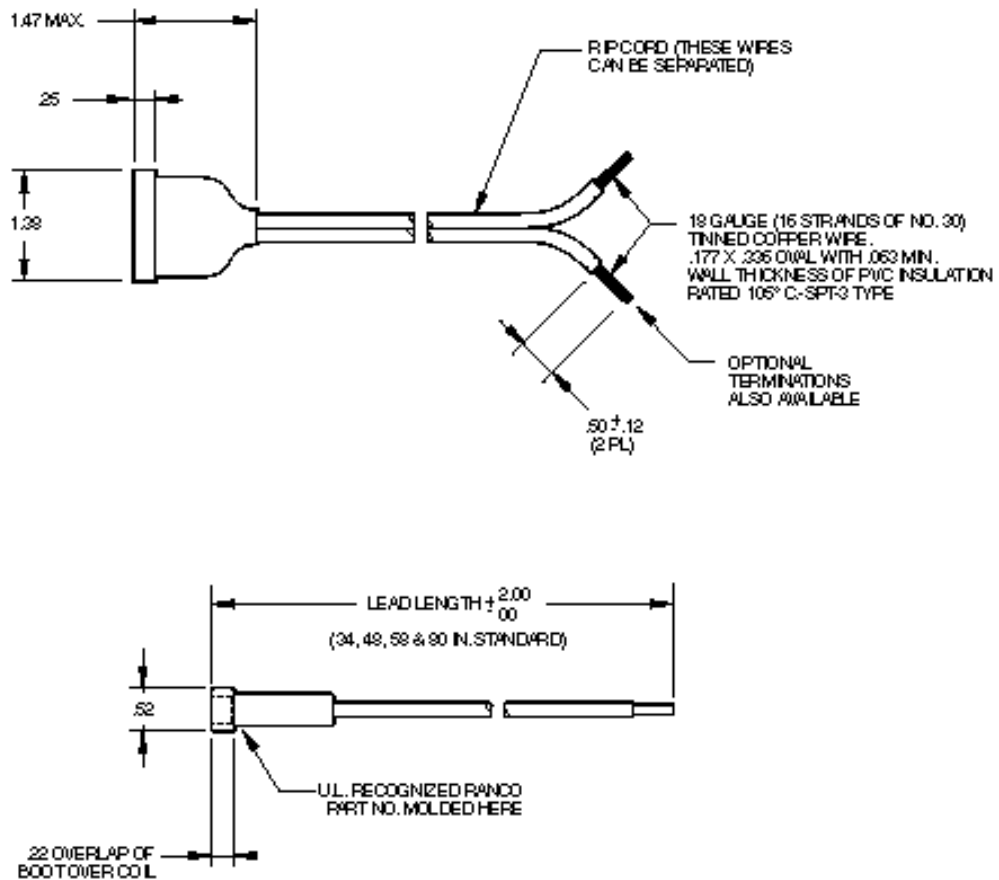

All components herein are recognized under UL File MH 5961 and CSA File FR 1942

Contact Ranco North America marketing for further information or application assistance.